

CATALOG

DE PRODUSE



DESPRE NOI

Lider național în vânzarea de echipamente și servicii destinate domeniului electric, ELBI este astăzi, după 28 de ani de activitate neîntreruptă, cel mai mare vânzător din România de echipamente electrice de joasă tensiune, cum ar fi: corpuri de iluminat stradale și industriale, corpuri de iluminat decorative, surse de iluminat, transformatoare, cabluri electrice, trasee pentru cabluri, sisteme electrice de automatizare, sisteme de protecție și avertizare pentru circuitele electrice. Elbi oferă o gamă largă de categorii de produse care înglobează, peste 30.000 de repere distincte, dintre care 18.000 sunt disponibile permanent în stoc. Business-ul este împărțit pe trei canale de vânzare, după cum urmează:

DISTRIBUȚIA

Miezul tradițional al afacerii cu un grad de acoperire (verticală și orizontală) extrem de ridicat. O componentă importantă a acestei divizii este și departamentul Retail (DIY) care se adresează conturilor mari, precum lanțuri de hypermarketuri sau magazine de bricolaj. Printre clienții din portofoliu se numără Leroy Merlin, Kingfisher, Hornbach, Rewe etc.

ELBI UNIVERSUL ELECTRICELOR

Este rezultatul eforturilor de implementare a noii strategii de dezvoltare a companiei, de trecere de la

un model de business tradițional orientat spre distribuție și vânzare clasică, la cel de furnizor de servicii și soluții personalizate. Pe termen mediu sunt prevăzute o serie de acțiuni care deschid noi opțiuni și metode de interacțiune, care ne vor permite să răspundem în cel mai profesionist mod tuturor solicitărilor. Știm că toate proiectele sunt importante, fie mici sau mari, și investim pentru a ne sprijini clienții în finalizarea acestora în cel mai scurt timp, cu cele mai optime produse și soluții.

ELBI ENERGY PROJECTS

Divizia destinată execuției de proiecte, reușind în scurt timp să își câștige un renume în piața, detașându-se prin abilități precum inovație, dinamism, flexibilitate, seriozitate și integritate.

1. Servicii de proiectare și execuție pentru:
 - Iluminat public stradal și rețele electrice;
 - Iluminat arhitectural și rezidențial;
 - Iluminat clădiri de birouri;
 - Iluminat industrial;
 - Tablouri electrice;
 - Instalații electrice pentru interior și exterior;
 - Instalații sisteme fotovoltaice;
 - Stații reîncărcare mașini electrice.
2. Management energetic.
3. Întreținerea și mentenanța sistemelor electrice.



Solentis este un brand românesc născut din dorința sinceră de a răspunde cerințelor tot mai complexe și diversificate ale pieței locale și internaționale. Este un brand profesional, perfect adaptat nevoilor firmelor de proiectare, arhitecților, dezvoltatorilor și mediului de afaceri, respectând cu strictețe cerințele tehnice impuse de autoritățile locale și municipalitățile din România. Produsele Solentis sunt utilizate cu preponderență în lucrări de modernizare, extindere și reabilitare a iluminatului stradal, pietonal, urban și decorativ. Până în prezent, au fost instalate peste 280.000 de corpuri de iluminat, în cadrul a peste 800 de proiecte publice.



Brandul Erste este specializat în corpuri de iluminat decorative, concepute pentru a aduce eleganță și funcționalitate în spațiile de locuit – apartamente, case, dar și în diverse spații interioare sau exterioare. Cu peste 1000 de modele, Erste oferă soluții care răspund celor mai creative preferințe și celor mai exigente cerințe estetice. Fie că îți dorești un design clasic, modern sau îndrăzneț, Erste îți poate transforma ambientul. De asemenea, latura practică nu a fost neglijată – fiecare corp de iluminat este proiectat să se potrivească perfect în orice tip de decor, aducând un plus de stil și funcționalitate.



Pulsar este brandul dedicat dispozitivelor SMART, dezvoltate pe baza tehnologiei Tuya Smart. Această tehnologie permite ca orice produs electric sau electronic, indiferent de caracteristici sau funcționalități, să fie interconectat și controlat digital, ușor și eficient. Tuya Smart reprezintă o soluție completă, devenită rapid prima platformă all-in-one adoptată la scară largă de majoritatea producătorilor globali de echipamente inteligente. Brandul Pulsar aduce pe piața inovație, conectivitate și eficiență, adaptându-se cerințelor actuale ale utilizatorilor.



Protejarea mediului înconjurător și reducerea impactului schimbărilor climatice reprezintă una dintre direcțiile prioritare ale Uniunii Europene, care impune standarde stricte și reglementări exigente privind eficiența energetică a surselor de iluminat. În acest context, Total Green se aliniază acestor cerințe și aduce pe piață o gamă de produse inovatoare, durabile și prietenoase cu mediul. Sursele de iluminat oferite de Total Green sunt concepute pentru a asigura un consum redus de energie, fără a compromite performanța sau calitatea luminii. Astfel, brandul contribuie activ la un viitor sustenabil și adoptarea soluțiilor ecologice în iluminat.



Novelite este brandul cu cea mai mare diversitate din portofoliul Elbi Electric, oferind produse din toate categoriile principale. Datorită gamei extinse de funcționalități și soluții tehnice, acest brand acoperă o arie largă de aplicații. Este ideal atât pentru retail și magazine specializate, cât și pentru profesioniști – electricieni și instalatori. Fie că vorbim despre conecție, trasee pentru cabluri, aparataj, surse de iluminat sau corpuri de iluminat tehnic, produsele Novelite se remarcă prin calitate constantă, fiabilitate și accesibilitate. În plus, poziționarea într-un segment de preț economic îl face extrem de competitiv pe piața de profil.



Homelight este brandul dedicat celor care caută soluții de iluminat și conecție accesibile, fără compromisuri în ceea ce privește calitatea. Odată cu noua identitate vizuală, ne reafirmăm angajamentul de a oferi produse fiabile și eficiente, adaptate nevoilor fiecărui spațiu. Portofoliul Homelight include o gamă variată de corpuri de iluminat decorative și tehnice, surse de iluminat, lanterne și prelungitoare – toate concepute pentru a asigura un iluminat optim, la un preț corect. Noul logo și ambalajele actualizate sunt gândite pentru a reflecta clar valorile brandului și pentru a fi ușor de recunoscut de către clienții noștri.



Brandul Elbi Electric face parte din portofoliul ELBI Electric & Lighting, care se ocupă cu producția de prize și întrerupătoare, cu accent pe aparataj minimalist și de calitate. Elbi Electric s-a impus pe piața industriei electrice datorită angajamentului față de calitate și inovație. Gama de produse cuprinde prize, întrerupătoare și accesoriile necesare, într-o varietate de modele și culori, oferind soluții eficiente pentru nevoile clienților. Cu experiență îndelungată și o reputație solidă în industrie, brandul a câștigat încrederea clienților atât pe piața locală, cât și internațională, devenind un nume cunoscut în domeniu.



Inlet reunește o gamă extinsă de produse din domeniul conecției și rețelisticii. Gama include prelungitoare, derulatoare, fișe, cuple, accesoriile pentru smartphone, precum și alte dispozitive conexe, utile atât în mediul rezidențial, cât și în cel profesional. Fiecare produs este conceput pentru a răspunde nevoilor actuale ale utilizatorilor, fiind adaptat cerințelor moderne de conectivitate, siguranță și funcționalitate. Brandul Inlet reflectă preocuparea constantă pentru inovație, siguranță și eficiență, oferind soluții fiabile și versatile, mereu în pas cu tendințele tehnologice actuale.

ABOUT US

National leader in the professional distribution of products and services in the electrical field, ELBI is today, after 28 years of uninterrupted activity, the largest distributor of electrical products in Romania, including: street and industrial light fittings, decorative lighting fittings, lamps, transformers, power cables, cable trays, electrical automation systems, protection and warning systems for electrical circuits. Elbi offers a wide range of product categories including over 30,000 distinct items, of which 18,000 are permanently available in stock. The business is divided into 3 sales channels corresponding to three divisions:

DISTRIBUTION

Traditional core business with extremely high vertical and horizontal market coverage. An important component of this division is the Retail (DIY) department targeting large accounts, such as hypermarket chains or DIY stores. Among the clients in the portfolio are also Leroy Merlin, Kingfisher, Hornbach, Rewe.

ELBI UNIVERSUL ELECTRICELOR

ELBI Universul Electricelor is the result of efforts to implement the new development strategy, moving from a traditional business model (oriented

towards classic distribution and sale) to a more focused and personalized products and services model. In the medium term we designed a set of actions that open up new options and methods of interaction, which will allow us to respond in the most professional way to all requests. We know that all projects are important, whether small or large, and we invest to support our clients in completing them in the shortest time, with the most suitable products and solutions.

ELBI ENERGY PROJECTS

ELBI Energy Projects is the division dedicated to project execution, quickly managing to gain a reputation in the market, standing out due to qualities such as innovation, dynamism, flexibility, seriousness and integrity.

1. Design and execution services for:
 - Street public lighting and electrical networks;
 - Architectural and residential lighting;
 - Office building lighting;
 - Industrial lighting;
 - Electrical panels;
 - Indoor and outdoor electrical installations;
 - Photovoltaic systems;
 - Electric vehicle charging stations.
2. Energy management.
3. Maintenance and upkeep of electrical systems.



Solentis is a Romanian brand born from the genuine desire to meet the increasingly complex and diverse demands of both local and international markets. It is a professional brand, perfectly adapted to the needs of design firms, architects, developers and the business environment, strictly respecting the technical requirements imposed by local authorities and municipalities in Romania. Solentis products are predominantly used in modernization, expansion and rehabilitation works of street, pedestrian, urban and decorative lighting. To date, over 280,000 lighting fixtures have been installed across more than 800 public projects.



The Erste brand specializes in decorative lighting fixtures, designed to bring elegance and functionality to living spaces – apartments, houses, but also various indoor or outdoor spaces. With over 1000 models, Erste offers solutions that meet the most creative preferences and the most demanding aesthetic requirements. Whether you want a classic, modern or bold design, Erste can transform your environment. The practical side has also not been neglected – each lighting fixture is designed to fit perfectly into any type of decor, bringing an extra touch of style and utility.



Pulsar is the brand dedicated to state-of-the-art SMART devices, developed based on Tuya Smart technology. This technology allows any electrical or electronic product, regardless of features or functionality, to be interconnected and digitally controlled, easily and efficiently. Tuya Smart represents a complete solution, which has quickly become the first all-in-one platform widely adopted by most global manufacturers of smart equipment. The Pulsar brand brings innovation, connectivity and efficiency to the market, adapting to users' current needs.



Protecting the environment and reducing the impact of climate change is one of the priority directions of the European Union, which imposes strict standards and demanding regulations regarding the energy efficiency of lighting sources. In this context, Total Green aligns with these requirements and brings to the market a range of innovative, sustainable and environmentally friendly products. The lighting sources offered by Total Green are designed to ensure low energy consumption, without compromising performance or quality of light. Thus, the brand actively contributes to a sustainable future and the adoption of eco-friendly solutions in lighting.



Novelite is the brand with the greatest diversity within the Elbi Electric portfolio, offering products across all major categories. Thanks to the extensive range of functionalities and technical solutions, this brand covers a wide area of applications. It is ideal for both retail and specialized stores, as well as for professionals – electricians and installers. Whether we are talking about connections, cable routes, equipment, lighting sources or technical lighting fixtures, Novelite products stand out for their consistent quality, reliability and affordability. In addition, positioning in an economical price range makes it highly competitive in the market.



Homelight is the brand dedicated to those looking for affordable lighting and connectivity solutions without compromising quality. With the new visual identity, we reaffirm our commitment to offering reliable and efficient products, adapted to the needs of each space. The Homelight portfolio includes a wide range of decorative and technical lighting fixtures, light sources, lanterns and extension cords – all designed to ensure optimal lighting at a fair price. The new logo and updated packaging are designed to clearly reflect the brand values and to be easily recognizable by our customers.



The Elbi Electric brand is part of the ELBI Electric & Lighting portfolio, which specializes in the production of sockets and switches, with an emphasis on minimalist and quality equipment. Elbi Electric has established itself in the electrical industry thanks to its commitment to quality and innovation. The product range includes sockets, switches and the necessary accessories, in a variety of models and colors, offering efficient solutions to customer needs. With long-standing experience and a solid reputation in the industry, the brand has gained the trust of customers both on the local and international markets, becoming a well-known name in the field.



Inlet offers an extensive range of products in the field of connectivity and networking. The range includes extension cords, power strips, plugs, couplers, smartphone accessories, as well as other related devices, useful in both residential and professional environments. Each product is designed to meet the current needs of users, being adapted to modern requirements for connectivity, safety and functionality. The Inlet brand reflects the ongoing commitment for innovation, safety and efficiency, offering reliable and versatile solutions, keeping pace with current technological trends.

CUPRINS

TABLE OF CONTENTS

04

Despre noi

About Us

08

Cuprins

Table of contents

12

Cum să înțelegem acest catalog

How to understand this catalog

15

Legenda

Legend

18

Corpuri de iluminat decorative

Decorative lighting fixtures

| | |
|---|-----|
| Plafoniere interior LED - Indoor LED ceiling lamps | 20 |
| Aplice interior LED - Indoor LED wall lamps | 54 |
| Pendule interior LED - Indoor LED pendants | 58 |
| Lustre interior LED - Indoor LED chandelier | 62 |
| Veioze LED - LED lamps | 66 |
| Lămpi veghe LED - LED night lights | 68 |
| Spoturi interior LED - Indoor LED spotlight | 74 |
| Accesorii interior LED - Indoor LED accessories | 78 |
| Plafoniere exterior LED - Outdoor LED ceilings lamps | 80 |
| Aplice exterior LED - Outdoor LED wall lamps | 84 |
| Spoturi exterior LED - Outdoor LED spotlights | 92 |
| Lămpi solare exterior LED - Outdoor LED solar lights | 96 |
| Lanterne LED - LED flashlight | 100 |
| Plafoniere interior dulie - Indoor ceiling lamp with sockets | 104 |
| Aplică interior dulie - Indoor wall lamp with socket | 110 |
| Pendule interior dulie - Indoor pendant with socket | 120 |
| Lustre interior dulie - Indoor chandelier with socket | 126 |
| Lămpi interior dulie - Indoor lamps with socket | 142 |
| Lămpi de birou dulie - Desk lamps with socket | 144 |
| Accesorii interior dulie - Indoor socket accessories | 148 |
| Plafoniere exterior dulie - Outdoor ceilings lights with socket | 152 |
| Aplice exterior dulie - Outdoor wall lights with socket | 154 |
| Pendule exterior dulie - Outdoor pendants with socket | 162 |
| Ghirlandă exterior dulie - Outdoor string light with socket | 164 |
| Glob exterior dulie - Outdoor globe with socket | 166 |
| Spoturi exterior dulie - Outdoor spotlight with socket | 168 |
| Stâlp exterior dulie - Outdoor light pole with socket | 170 |

174

Surse de iluminat

Light sources

| | |
|--------------------------------------|-----|
| Baghetă LED link - LED link lightbar | 176 |
| Bandă LED - LED strip | 180 |
| Bec LED - LED bulb | 186 |
| Tub LED - LED tube | 194 |
| Bec halogen - Halogen bulb | 196 |
| Bec incandescent - Incandescent bulb | 200 |

202**SOLUȚII PENTRU CASE SMART**

Smart Home Solutions

Soluții pentru case smart - Smart home solutions | 204

210**Aparataj**

Switches and Sockets

Gama de aparataj touch - Pulsar touch product range | 212

Gama de aparataj Moda Voice - Moda Voice product range | 216

Gama de aparataj Jazz - Jazz product range | 222

Gama de aparataj Zena - Zena product range | 228

Gama de aparataj Zirve - Zirve product range | 236

Gama de aparataj Alsu - Alsu product range | 242

Gama de aparataj Eva - Eva product range | 246

Gama de aparataj Total Green - Total Green product range | 250

Gama de aparataj Novelite - Novelite product range | 252

254**Conectică**

Connectors

Prelungitoare - Extension cord | 256

Grupuri priză - Power strips without cord | 260

Ștehere-cuple - Plugs and couplings | 262

Întreprupătoare pe fir - On-wire switches | 264

Adaptoare - Adapters | 266

Prize programabile - Programmable sockets | 268

Sonerii fără fir - Wireless doorbells | 270

Accesorii TV - TV accessories | 272

Ventilatoare - Fans | 274

276**Protecții**

Power automation

Întreprupătoare automate - Modular circuit breakers | 278

Întreprupătoare cu protecție diferențială - Residual current circuit breakers | 280

Siguranțe fuzibilă - Fuses | 282

Contactoare - Contactors | 284

Comutatoare cu came - Cam switches | 286

Tablouri / Cofrete metalice - Metallic electrical boxes | 288

Programator tensiune - Voltage output digital switch | 290

Priză șină DIN - DIN rail socket | 291

292**Corpuri de iluminat tehnice**

Technical Lighting Fixtures

Corpuri liniare interior - Indoor linear light | 294

Panouri LED - LED panels | 302

Downlight - Downlight | 316

Iluminat șină - Track lighting | 320

Corp bat - Bat light | 328

384

Corpuri etanșe praf și apă - Dust and waterproof lighting fixtures | 332

High bay - High bay | 338

Proiectoare LED - LED floodlights | 342

Corpuri stradale și pietonale - Street and pedestrian lights | 348

Stâlpi de iluminat - Lighting poles | 356

Corpuri arhitecturale - Architectural light fixtures | 364

Corpuri solare - Solar fixtures | 366

Iluminat urgență - Emergency lighting | 370

Senzori - Sensors | 378

Accesorii alimentare - Power supply accessories | 382

Trasee electrice

Cable Management Systems

Jgheaburi metalice - Cable trays | 386

Jgheab de sârmă - Wire mesh cable tray | 388

Canal cablu - Cable trunking | 398

Tub flexibil - Flexible conduit | 400

Coliere PVC - PVC cable ties | 404

Bandă izolatoare - Electrical insulating tape | 406

Cleme pe șir - Terminal blocks | 408

410**Cabluri**

Cables

Cabluri de curenți slabi - Low current cable | 412

Descoperiți structura noului catalog și aflați cum puteți găsi rapid produsele dorite. Ghidul vă va ajuta să navigați eficient și să găsiți informațiile esențiale despre fiecare produs, pentru o experiență simplificată.

CALE DE ORIENTARE

Pentru a face navigarea mai ușoară, catalogul nostru este organizat pe mai multe niveluri: categorii de produse, subcategorii de produse și variantele de produs prezentate în tabel. Anumite capitole, precum Aparataj, Corpurile de Iluminat Decorativ și Smarthome, au o structură adaptată, pentru o mai bună claritate.

NAVIGATION PATH

To make navigation easier, our catalog is organized on several levels: product category, product subcategory and product variants presented in the table. Certain chapters, such as Switches & Sockets, Decorative Lighting Fixtures and Smarthome, have an adapted structure for better clarity.

CATEGORII DE PRODUSE

Principalele categorii sunt evidențiate pe ambele margini ale paginilor, în casete gri, asemenea unor semne de carte. Caseta de culoare portocalie vă ajută să identificați ușor capitolul la care vă aflați.

PRODUCT CATEGORIES

The main categories are marked on both page margins with grey boxes, resembling bookmarks. The orange-colored box helps you easily identify the chapter you are currently in.

SUBCATEGORII DE PRODUSE

Fiecare subcategorie începe cu o pagină de introducere, unde sunt prezentate caracteristicile esențiale ale produselor. Aceste informații sunt disponibile în două limbi: română și engleză.

PRODUCT SUBCATEGORIES

Each subcategory begins with an introduction page, where the essential features of the products are presented. This information is available in two languages: Romanian and English.

Discover the structure of the new catalog and learn how to quickly find the products you want. The guide will help you navigate efficiently and find essential information about each product, for a simplified experience.

INFORMAȚII SUPLIMENTARE DESPRE PRODUS
Deasupra tabelului pot apărea pictograme care evidențiază caracteristici tehnice generale pentru întreaga familie de produse.

ADDITIONAL PRODUCT INFORMATION

Above the table, icons may appear that highlight general technical characteristics for the entire product family.

TABELUL DE PRODUSE

În funcție de numărul de produse și familii incluse, tabelul poate apărea atât pe pagina din dreapta, cât și pe cea din stânga. Formatul acestuia este standardizat pentru o lectură ușoară:

- Textul portocaliu – informațiile în engleză.
- Textul negru – informațiile în română.
- Prima linie a tabelului indică brandul din care face parte familia de produse.
- Informații incluse: codul de articol, denumirea produsului, culoarea, materialul, dimensiunile și alte specificații relevante.

PRODUCT TABLE

Depending on the number of products and families included, the table can appear on both the right and left pages. Its format is standardized for easy reading:

- Orange text – information in English.
- Black text – information in Romanian.
- The first line of the table indicates the brand to which the product family belongs.
- Information included: article code, product name, color, material, size and other relevant details.

INFORMAȚII ADIȚIONALE / COMPATIBILITATE / ATENȚIONĂRI

La baza paginii, în casete evidențiate, pot fi oferite detalii suplimentare despre produs, compatibilitatea acestuia cu alte accesorii sau atenționări importante.

ADDITIONAL INFORMATION / COMPATIBILITY / WARNINGS

At the bottom of the page, in highlighted boxes, additional details about the product, its compatibility with other accessories or important warnings may be provided.

Regăsiți legenda pictogramelor la pagina următoare. / You can find the legend of the icons on the next page.

DORIȚI SĂ EXPLORAȚI RAPID ȘI UȘOR TOATE PRODUSELE ELBI?

Acum puteți descărca catalogul de produse direct pe dispozitivul dumneavoastră!

Scanați codul QR de mai jos și accesați instantaneu catalogul complet, cu toate informațiile esențiale despre produse, caracteristici și specificații.

Totul la îndemână, oricând aveți nevoie!



www.elbielectric.ro/cataloge

Adresa: Str. Italia 1-7, P3 Bucharest A1,
Logistic Park, Depozit 3, Chiajna - Ilfov

Tel: +40 (21) 420 23 41
Fax: +40 (21) 420 06 72

email: office@elbielectric.ro

www.elbielectric.ro



ICON

Cum să citești pictogramele din catalog.

| | | | | | |
|--|--|--|-------------------------------------|--|--|
| | Tipul sursei de lumină | | Sursa de iluminat recomandată | | Bluetooth + Wi-Fi (802.11 b/g/n 2.4 Ghz) |
| | Tipul de LED | | Temperatura mediului ambiant | | WIFI 802.11 b/g/n / RF868 Mhz |
| | Tensiune de alimentare | | Numărul maxim de ore de funcționare | | Monitorizare consum din aplicație |
| | Tensiune de alimentare | | Cu ventilator | | Slot microSD max. 128GB |
| | Tipuri de clasa energetică | | Buton touch | | Ajustabil |
| | Tipul de lumină - RGB | | Tipul de acumulator | | Tratamente chimice |
| | Temperatură de culoare - Lumină caldă | | Curbă de declanșare C | | Sub Tencuială |
| | Temperatură de culoare - Lumină neutră | | Tip diferențial AC | | Peste Tencuială |
| | Temperatură de culoare - Lumină rece | | Indice de redare al culorilor | | |
| | Lumină albastră | | Unghiul de dispersie a luminii | | |
| | Lumină verde | | Efecte luminoase | | |
| | Lumină roșie | | Telecomandă | | |
| | Temperatură de culoare corelată | | Curent maxim admis | | |
| | Putere maximă a sursei de lumină | | Dulie G9 | | |
| | Gradul de protecție la apă și praf | | Dulie GU10 | | |
| | Gradul de rezistență la șoc | | Dulie E14 | | |
| | Numărul de dulii | | Dulie E27 | | |
| | Senzor de mișcare | | Dulie T4 | | |
| | Senzor crepuscular | | Lungime cablu | | |
| | | | Înterupător pe cablu | | |
| | | | Înterupător pe perete | | |
| | | | Înterupător | | |
| | | | Dimabil | | |
| | | | Nedimabil | | |

WANT TO QUICKLY AND EASILY EXPLORE ALL ELBI PRODUCTS?

Now you can download the product catalog directly to your device!

Scan the QR code below and instantly access the complete catalog, with all the essential product information, features and specifications.

Everything at your fingertips, whenever you need it!



www.elbielectric.ro/cataloge

Address: 1-7 Italia Street, Building P3, Bucharest A1 Logistic Park, Warehouse 3, Chiajna – Ilfov, Romania

Phone: +40 (21) 420 23 41
Fax: +40 (21) 420 06 72

email: office@elbielectric.ro

www.elbielectric.ro



ICON

How to interpret the icons in the catalog.

- | | | | | | |
|--|-----------------------------------|--|-----------------------------------|--|---|
| | Light source type | | Recommended light source | | Bluetooth + Wi-Fi (802.11 b/g/n 2.4 Ghz) |
| | LED type | | Ambient temperature | | WIFI 802.11 b/g/n / RF868 Mhz |
| | Power supply voltage: 230V | | Maximum number of operating hours | | Monitoring consumption from the application |
| | Power supply voltage: 12V | | With fan | | MicroSD slot max. 128GB |
| | Energy efficiency classes | | Touch button | | Adjustable |
| | Light type - RGB | | Battery type | | Chemical treatments |
| | Color temperature - Warm light | | Tripping Curve: C | | Under plaster |
| | Color temperature - Neutral light | | Differential type AC | | Above plaster |
| | Color temperature - Cold light | | Color rendering index | | |
| | Blue light | | Light dispersion angle | | |
| | Green light | | Light effects | | |
| | Red light | | Remote control | | |
| | Correlated color temperature | | Maximum permissible current | | |
| | Maximum power of the light source | | G9 socket | | |
| | Ingress protection rating | | GU10 socket | | |
| | Impact protection rating | | E14 socket | | |
| | Number of sockets | | E27 socket | | |
| | Motion sensor | | T4 socket | | |
| | Twilight sensor | | Cable length | | |
| | | | Inline switch | | |
| | | | Wall switch | | |
| | | | Switch | | |
| | | | Dimmable | | |
| | | | Non-dimmable | | |

CORPURI DE ILUMINAT DECORATIVE

DECORATIVE LIGHTING FIXTURES

| | | |
|--|---|-----|
| INDOOR LED | Plafoniere interior LED - Indoor LED ceiling lamps | 20 |
| | Aplice interior LED - Indoor LED wall lamps | 54 |
| | Pendule interior LED - Indoor LED pendants | 58 |
| | Lustre interior LED - Indoor LED chandelier | 62 |
| | Veioze LED - LED lamps | 66 |
| | Lămpi veghe LED - LED night lights | 68 |
| | Spoturi interior LED - Indoor LED spotlight | 74 |
| | Accesorii interior LED - Indoor LED accessories | 78 |
| EXTERIOR LED | Plafoniere exterior LED - Outdoor LED ceilings lamps | 80 |
| | Aplice exterior LED - Outdoor LED wall lamps | 84 |
| | Spoturi exterior LED - Outdoor LED spotlights | 92 |
| | Lămpi solare exterior LED - Outdoor LED solar light | 96 |
| | Lanterne LED - LED flashlight | 100 |
| INDOOR DULIE | Plafoniere interior dulie - Indoor ceiling lamp with sockets | 104 |
| | Aplică interior dulie - Indoor wall lamp with socket | 110 |
| | Pendule interior dulie - Indoor pendant with socket | 120 |
| | Lustre interior dulie - Indoor chandelier with socket | 126 |
| | Lămpi interior dulie - Indoor lamps with socket | 142 |
| | Lămpi de birou dulie - Desk lamps with socket | 144 |
| Accesorii interior dulie - Indoor socket accessories | 148 | |
| EXTERIOR DULIE | Plafoniere exterior dulie - Outdoor ceilings lights with socket | 152 |
| | Aplice exterior dulie - Outdoor wall lights with socket | 154 |
| | Pendule exterior dulie - Outdoor pendants with socket | 162 |
| | Ghirlandă exterior dulie - Outdoor string light with socket | 164 |
| | Glob exterior dulie - Outdoor globe with socket | 166 |
| | Spoturi exterior dulie - Outdoor spotlight with socket | 168 |
| | Stâlp exterior dulie - Outdoor light pole with socket | 170 |



PLAFONIERE INTERIOR LED

INDOOR LED CEILING LAMPS

RO

Plafonierele LED sunt soluții eficiente pentru iluminatul general al încăperilor, oferind un design discret, o lumină uniformă și un consum redus de energie.

REPERE

- Distribuție uniformă – iluminare LED amplă și echilibrată;
- Economie de spațiu – montaj direct pe tavan, fără a încălca vizual spațiul;
- Durabilitate ridicată – tehnologie LED pentru o durată lungă de viață.

EN

LED ceiling lights are practical and efficient solutions for general room lighting, providing a discreet design, uniform illumination, and low energy consumption.

FEATURES

- Even distribution – ample and well-balanced LED lighting;
- Space-saving – direct ceiling mounting without visual clutter;
- High durability – LED technology for a long lifespan.

LED 230V IP20 CCT



| RO | Cod | Denumire | Putere consumată | Temperatură de culoare | Flux luminos | Material | Culoare | Dimensiune |
|----|------|----------|------------------|------------------------|---------------|----------|---------|------------|
| EN | Code | Name | Power | Color temperature | Luminous flux | Material | Color | Size |

ERSTE

| | | | | | | | |
|-----------|-------------------------------------|------|------------|--------|-----------------------------------|-------------|--------------|
| EL0075432 | Plafonieră ABYS / Ceiling lamp ABYS | 120W | 3000-6000K | 8400lm | Metal + Acrylic / Metal + Acrylic | Alb / White | 480x480x70mm |
|-----------|-------------------------------------|------|------------|--------|-----------------------------------|-------------|--------------|



LED 230V IP20 CCT

ERSTE

| | | | | | | | |
|-----------|---|-----|------------|--------|-------------|-------------|-----------|
| EL0075181 | Plafonieră ADALINE / Ceiling lamp ADALINE | 38W | 3000-6000K | 2090lm | Metal + PVC | Alb / White | 385x95mm |
| EL0075182 | | 48W | | 2640lm | | | 480x100mm |



LED 230V IP20 CCT

ERSTE

| | | | | | | | |
|-----------|---------------------------------------|------|------------------|--------|-----------------------------------|-------------|--------------|
| EL0075389 | Plafonieră AGATA / Ceiling lamp AGATA | 100W | 3000-6000K / RGB | 7000lm | Metal + Acrylic / Metal + Acrylic | Alb / White | 680x110mm |
| EL0075388 | | 40W | | 2400lm | | | 380x380x75mm |



LED 230V IP20 CCT

ERSTE

| | | | | | | | |
|-----------|--|-----|------------|--------|---------------------------|-------------|-----------|
| EL0084351 | Plafonieră ventilator BREZZY / Ceiling fan lamp BREZZY | 48W | 3000-6000K | 3120lm | Metal + ABS / Metal + ABS | Alb / White | 490x490mm |
|-----------|--|-----|------------|--------|---------------------------|-------------|-----------|

- 5 trepte de viteză ale ventilatorului, până la 1000rpm, 36db
- 5 fan speed, levels up to 1000 RPM, 36 dB

CORPURI DE ILUMINAT DECORATIVE LED | INTERIOR | PLAFONIERE

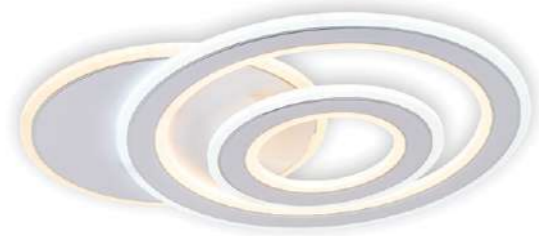

| RO | Cod | Denumire | Putere consumată | Temperatură de culoare | Flux luminos | Material | Culoare | Dimensiune |
|----|------|----------|------------------|------------------------|---------------|----------|---------|------------|
| EN | Code | Name | Power | Color temperature | Luminous flux | Material | Color | Size |

ERSTE

| | | | | | | | |
|-----------|--|-----|------------|--------|--------------------------------------|-------------|--------------|
| EL0075430 | Plafonieră ALLA / Ceiling lamp ALLA | 98W | 3000-6000K | 6860lm | Metal + Acrylic / Metal + Acrylic | Alb / White | 510x420x70mm |
|-----------|--|-----|------------|--------|--------------------------------------|-------------|--------------|



ERSTE

| | | | | | | | |
|-----------|--|------|------------------|--------|--------------------------------------|-------------|--------------|
| EL0075384 | Plafonieră AMELIA / Ceiling lamp AMELIA | 120W | 3000-6000K / RGB | 7200lm | Metal + Acrylic / Metal + Acrylic | Alb / White | 500x500x72mm |
|-----------|--|------|------------------|--------|--------------------------------------|-------------|--------------|



ERSTE

| | | | | | | | |
|-----------|--------------------------------------|-----|------------|--------|---|--------------------------------|----------|
| EL0075177 | Plafonieră AMY / Ceiling lamp AMY | 68W | 3000-6000K | 3740lm | Metal + Acrylic + Silicon / Metal + Acrylic + Silicone | Alb + Negru / White + Black | 490x58mm |
|-----------|--------------------------------------|-----|------------|--------|---|--------------------------------|----------|



ERSTE

| | | | | | | | |
|-----------|--|-----|-------|--------|-----------------|-------------|----------|
| EL0060124 | Plafonieră ASANA / Ceiling lamp ASANA | 36W | 4000K | 2700lm | Metal + Plastic | Alb / White | 495x70mm |
|-----------|--|-----|-------|--------|-----------------|-------------|----------|

LED DECORATIVE LIGHTING FIXTURES | INDOOR | CEILING LAMPS



| RO | Cod | Denumire | Putere consumată | Temperatură de culoare | Flux luminos | Material | Culoare | Dimensiune |
|----|------|----------|------------------|------------------------|---------------|----------|---------|------------|
| EN | Code | Name | Power | Color temperature | Luminous flux | Material | Color | Size |

ERSTE

| | | | | | | | |
|-----------|--------------------------------------|-----|------------|--------|--------------------------------------|-------------|--------------|
| EL0075429 | Plafonieră AVA / Ceiling lamp AVA | 88W | 3000-6000K | 6160lm | Metal + Acrylic / Metal + Acrylic | Alb / White | 510x450x55mm |
|-----------|--------------------------------------|-----|------------|--------|--------------------------------------|-------------|--------------|



ERSTE

| | | | | | | | |
|-----------|--|------|------------|--------|--------------------------------------|-------------|-----------|
| EL0075355 | Plafonieră AZALIA / Ceiling lamp AZALIA | 100W | 3000-6000K | 7100lm | Metal + Acrylic / Metal + Acrylic | Alb / White | 680x110mm |
|-----------|--|------|------------|--------|--------------------------------------|-------------|-----------|



ERSTE

| | | | | | | | |
|-----------|--|-----|------------|--------|--------------------------------------|-------------|----------|
| EL0068252 | Plafonieră BARY / Ceiling lamp BARY | 95W | 3000-6000K | 5000lm | Metal + Acrylic / Metal + Acrylic | Alb / White | 480x50mm |
|-----------|--|-----|------------|--------|--------------------------------------|-------------|----------|



ERSTE

| | | | | | | | |
|-----------|--|-----|------------|--------|--------------------------------------|---------------------------------|----------|
| EL0071775 | Plafonieră BLAZE / Ceiling lamp BLAZE | 32W | 3000-6000K | 2240lm | Metal + Plastic / Metal + Acrylic | Negru + Auriu / Black + Gold | 390x80mm |
|-----------|--|-----|------------|--------|--------------------------------------|---------------------------------|----------|

LED 230V IP20



| Cod | Denumire | Putere consumată | Temperatură de culoare | Flux luminos | Material | Culoare | Dimensiune |
|--------------|---------------------------------------|------------------|------------------------|---------------|-----------------|--------------------------------|------------|
| Code | Name | Power | Color temperature | Luminous flux | Material | Color | Size |
| ERSTE | | | | | | | |
| EL0037944 | | 12W | | 840lm | | | 280x95mm |
| EL0037943 | Plafonieră WANDA / Ceiling lamp WANDA | 18W | 6500K | 1260lm | Metal + Plastic | Alb cu model / Patterned white | 330x100mm |
| EL0037942 | | 24W | | 1680lm | | | 380x110mm |

LED 230V IP20 CCT



| Cod | Denumire | Putere consumată | Temperatură de culoare | Flux luminos | Material | Culoare | Dimensiune |
|--------------|---------------------------------------|------------------|------------------------|--------------|-----------------|-----------------------------|------------|
| ERSTE | | | | | | | |
| EL0071770 | Plafonieră CANDY / Ceiling lamp CANDY | 58W | 3000-6000K | 3500lm | Metal + Plastic | Alb + Negru / White + Black | 500x60mm |

LED 230V IP20 CCT



| Cod | Denumire | Putere consumată | Temperatură de culoare | Flux luminos | Material | Culoare | Dimensiune |
|--------------|---------------------------------------|------------------|------------------------|--------------|-----------------------------------|-------------|--------------|
| ERSTE | | | | | | | |
| EL0075433 | Plafonieră CHARM / Ceiling lamp CHARM | 140W | 3000-6500K | 9100lm | Metal + Acrilic / Metal + Acrylic | Alb / White | 480x480x70mm |



LED 230V IP20



| RO | Cod | Denumire | Putere consumată | Temp. de culoare | Flux luminos | Material | Culoare | Dimensiune |
|--------------|-------------------------------------|----------|------------------|-------------------|-----------------------------------|------------------------------|---------|------------|
| EN | Code | Name | Power | Color temperature | Luminous flux | Material | Color | Size |
| ERSTE | | | | | | | | |
| EL0071591 | Plafonieră CLEO / Ceiling lamp CLEO | 32W | 4000K | 1920lm | Metal + Acrilic / Metal + Acrylic | Alb + Auriu / White + Gold | | 420x70mm |
| EL0071590 | | | | | | Negru + Auriu / Black + Gold | | |

| | | | | | | | | |
|-----------|-------------------------------------|-----|-------|--------|-----------------------------------|------------------------------|--|----------|
| EL0071591 | Plafonieră CLEO / Ceiling lamp CLEO | 32W | 4000K | 1920lm | Metal + Acrilic / Metal + Acrylic | Alb + Auriu / White + Gold | | 420x70mm |
| EL0071590 | | | | | | Negru + Auriu / Black + Gold | | |

CORPURI DE ILUMINAT DECORATIVE LED | INTERIOR | PLAFONIERE

LED 230V IP20 CCT

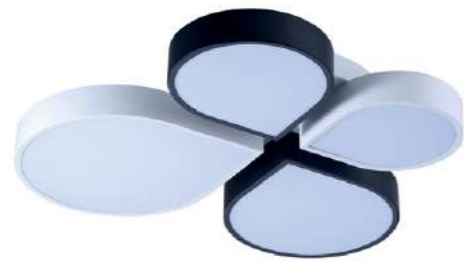

| RO | Cod | Denumire | Putere consumată | Temperatură de culoare | Flux luminos | Material | Culoare | Dimensiune |
|----|------|----------|------------------|------------------------|---------------|----------|---------|------------|
| EN | Code | Name | Power | Color temperature | Luminous flux | Material | Color | Size |

ERSTE

| | | | | | | | |
|-----------|---------------------------------------|-----|------------|--------|-----------------|-----------------------------|--------------|
| EL0071769 | Plafonieră CICEK / Ceiling lamp CICEK | 50W | 3000-6000K | 2560lm | Metal + Plastic | Alb + Negru / White + Black | 70x538x528mm |
|-----------|---------------------------------------|-----|------------|--------|-----------------|-----------------------------|--------------|



LED 230V IP20 CCT

ERSTE

| | | | | | | | |
|-----------|---|-----|------------|--------|-----------------------------------|-------------|---------------|
| EL0075352 | Plafonieră CIRCLE / Ceiling lamp CIRCLE | 90W | 3000-6000K | 6300lm | Metal + Acrylic / Metal + Acrylic | Alb / White | 590x480x110mm |
|-----------|---|-----|------------|--------|-----------------------------------|-------------|---------------|



LED 230V IP20

ERSTE

| | | | | | | | |
|-----------|---|-----|-------|--------|-----------------|-------------|-----------|
| EL0060161 | Plafonieră DIAMONDS / Ceiling lamp DIAMONDS | 24W | 4000K | 1800lm | Metal + Plastic | Alb / White | 415x85mm |
| EL0060162 | | 36W | | 2700lm | | | 515x105mm |



LED 230V IP20 CCT

ERSTE

| | | | | | | | |
|-----------|---------------------------------------|------|------------|--------|-----------------------------------|-------------|----------|
| EL0067631 | Plafonieră DOLCE / Ceiling lamp DOLCE | 100W | 3000-6400K | 6500lm | Metal + Acrylic / Metal + Acrylic | Alb / White | 500x50mm |
|-----------|---------------------------------------|------|------------|--------|-----------------------------------|-------------|----------|

LED DECORATIVE LIGHTING FIXTURES | INDOOR | CEILING LAMPS

LED 230V IP20 CCT



| RO | Cod | Denumire | Putere consumată | Temperatură de culoare | Flux luminos | Material | Culoare | Dimensiune |
|----|------|----------|------------------|------------------------|---------------|----------|---------|------------|
| EN | Code | Name | Power | Color temperature | Luminous flux | Material | Color | Size |

ERSTE

| | | | | | | | |
|-----------|---------------------------------------|-----|------------|--------|-----------------|-----------------------------|----------|
| EL0071767 | Plafonieră DONUT / Ceiling lamp DONUT | 45W | 3000-6000K | 2250lm | Metal + Plastic | Alb + Negru / White + Black | 500x90mm |
|-----------|---------------------------------------|-----|------------|--------|-----------------|-----------------------------|----------|



LED 230V IP20 CCT

ERSTE

| | | | | | | | |
|-----------|-------------------------------------|-----|------------|--------|---|----------------------------|----------|
| EL0075180 | Plafonieră ELIA / Ceiling lamp ELIA | 55W | 3000-6000K | 3025lm | Metal + Acrylic + Silicon / Metal + Acrylic + Silicon | Alb + Auriu / White + Gold | 520x68mm |
|-----------|-------------------------------------|-----|------------|--------|---|----------------------------|----------|



LED 230V IP20 CCT

ERSTE

| | | | | | | | |
|-----------|---|-----|------------|--------|-------------|----------------------------|--------------|
| EL0071766 | Plafonieră ELIPSE / Ceiling lamp ELIPSE | 80W | 3000-6000K | 5800lm | Metal + PVC | Alb + Auriu / White + Gold | 525x430x75mm |
|-----------|---|-----|------------|--------|-------------|----------------------------|--------------|



LED 230V IP20

ERSTE

| | | | | | | | |
|-----------|-------------------------------------|-----|-------|--------|-----------------|--------------------------------|-----------|
| EL0037938 | Plafonieră EMMA / Ceiling lamp EMMA | 12W | 6500K | 840lm | Metal + Plastic | Alb cu model / Patterned white | 280x95mm |
| EL0037937 | | 18W | | 1260lm | | | 330x100mm |
| EL0037936 | | 24W | | 1680lm | | | 380x110mm |

CORPURI DE ILUMINAT DECORATIVE

SURSE

SMART HOME

APARATAJ

CONECTICĂ

PROTECȚII

CORPURI DE ILUMINAT TEHNICE

TRASEE

CABLURI

DECORATIVE LIGHTING FIXTURES

SOURCES

SMART HOME

SWITCHES AND SOCKETS

CONNECTORS

POWER AUTOMATION

TECHNICAL LIGHTNING FIXTURES

CABLE MANAGEMENT SYSTEMS

CABLES

CORPURI DE ILUMINAT DECORATIVE LED | INTERIOR | PLAFONIERE



| RO | Cod | Denumire | Putere consumată | Temperatură de culoare | Flux luminos | Material | Culoare | Dimensiune |
|----|------|----------|------------------|------------------------|---------------|----------|---------|------------|
| EN | Code | Name | Power | Color temperature | Luminous flux | Material | Color | Size |

ERSTE

| | | | | | | | |
|-----------|---|------|------------|--------|-----------------------------------|-------------|---------------|
| EL0075354 | Plafonieră EUROPE / Ceiling lamp EUROPE | 140W | 3000-6000K | 9800lm | Metal + Acrylic / Metal + Acrylic | Alb / White | 790x560x120mm |
|-----------|---|------|------------|--------|-----------------------------------|-------------|---------------|



ERSTE

| | | | | | | | |
|-----------|-------------------------------------|-----|------------|--------|-----------------------------------|-------------|--------------|
| EL0075351 | Plafonieră EVIS / Ceiling lamp EVIS | 60W | 3000-6000K | 4500lm | Metal + Acrylic / Metal + Acrylic | Alb / White | 435x435x70mm |
|-----------|-------------------------------------|-----|------------|--------|-----------------------------------|-------------|--------------|



ERSTE

| | | | | | | | |
|-----------|-------------------------------------|-----|-------|----------|------------|---------------|----------|
| EL0081463 | Plafonieră FLUX / Ceiling lamp FLUX | 18W | 6000K | 1710lm | Metal + PS | Negru / Black | 300x50mm |
| EL0081465 | | 28W | | 2660lm | | | 400x50mm |
| EL0081466 | | 38W | | 500x50mm | | | |



ERSTE

| | | | | | | | |
|-----------|---------------------------------------|-----|------------|--------|-----------------|-----------------------------|----------|
| EL0081473 | Plafonieră FREYA / Ceiling lamp FREYA | 55W | 3000-6500K | 4675lm | Metal + Plastic | Alb + Negru / White + Black | 475x87mm |
|-----------|---------------------------------------|-----|------------|--------|-----------------|-----------------------------|----------|

LED DECORATIVE LIGHTING FIXTURES | INDOOR | CEILING LAMPS



| RO | Cod | Denumire | Putere consumată | Temperatură de culoare | Flux luminos | Material | Culoare | Dimensiune |
|----|------|----------|------------------|------------------------|---------------|----------|---------|------------|
| EN | Code | Name | Power | Color temperature | Luminous flux | Material | Color | Size |

ERSTE

| | | | | | | | |
|-----------|---------------------------------------|-----|------------|--------|---|-----------------------------|----------|
| EL0068254 | Plafonieră FRODO / Ceiling lamp FRODO | 33W | 3000-6000K | 1820lm | Oțel + Al + Silicon / Steel + Aluminum + Silicone | Alb + Negru / White + Black | 400x45mm |
| EL0068255 | | 35W | | 1920lm | | | |



ERSTE

| | | | | | | | |
|-----------|---|-----|-------|--------|-----------------|-------------|----------|
| EL0060117 | Plafonieră GALAXY / Ceiling lamp GALAXY | 24W | 4000K | 1680lm | Metal + Plastic | Alb / White | 455x75mm |
|-----------|---|-----|-------|--------|-----------------|-------------|----------|



ERSTE

| | | | | | | | |
|-----------|-------------------------------------|-----|-----------------|--------|-----------------|-------------|----------|
| EL0081472 | Plafonieră GERD / Ceiling lamp GERD | 48W | 3000-4000-6500K | 3600lm | Metal + Plastic | Alb / White | 450x85mm |
|-----------|-------------------------------------|-----|-----------------|--------|-----------------|-------------|----------|



ERSTE

| | | | | | | | |
|-----------|---|-----|-------|--------|-----------------|-------------|----------|
| EL0060115 | Plafonieră GLACIER / Ceiling lamp GLACIER | 24W | 4000K | 1680lm | Metal + Plastic | Transparent | 410x90mm |
|-----------|---|-----|-------|--------|-----------------|-------------|----------|

CORPURI DE ILUMINAT DECORATIVE LED | INTERIOR | PLAFONIERE

LED 230V IP20 CCT



| RO | Cod | Denumire | Putere consumată | Temperatură de culoare | Flux luminos | Material | Culoare | Dimensiune |
|----|------|----------|------------------|------------------------|---------------|----------|---------|------------|
| EN | Code | Name | Power | Color temperature | Luminous flux | Material | Color | Size |

ERSTE

| | | | | | | | |
|-----------|-------------------------------------|-----|------------|--------|-------------|----------------------------|----------|
| EL0075186 | Plafonieră GLOW / Ceiling lamp GLOW | 45W | 3000-6000K | 2700lm | Metal + PVC | Alb + Auriu / White + Gold | 490x70mm |
|-----------|-------------------------------------|-----|------------|--------|-------------|----------------------------|----------|

LED 230V IP20 CCT



ERSTE

| | | | | | | | |
|-----------|-------------------------------------|-----|------------|--------|---|----------------------------|----------|
| EL0075194 | Plafonieră GOLD / Ceiling lamp GOLD | 30W | 3000-6500K | 2040lm | Metal + silicon + Aluminiu / Metal + Silicone + Aluminium | Alb + Auriu / White + Gold | 300x50mm |
| EL0075195 | | 40W | | 2600lm | | | 400x50mm |

LED 230V IP20 CCT



ERSTE

| | | | | | | | |
|-----------|---|-----|------------|--------|-----------------|----------------------------|----------|
| EL0071772 | Plafonieră GRAVITY / Ceiling lamp GRAVITY | 48W | 3000-6000K | 3360lm | Metal + Plastic | Alb + Auriu / White + Gold | 480x50mm |
|-----------|---|-----|------------|--------|-----------------|----------------------------|----------|

LED DECORATIVE LIGHTING FIXTURES | INDOOR | CEILING LAMPS

LED 230V IP20



| RO | Cod | Denumire | Putere consumată | Temperatură de culoare | Flux luminos | Material | Culoare | Dimensiune |
|----|------|----------|------------------|------------------------|---------------|----------|---------|------------|
| EN | Code | Name | Power | Color temperature | Luminous flux | Material | Color | Size |

ERSTE

| | | | | | | | |
|-----------|-------------------------------------|-----|-------|--------|-----------------|--------------------------------|-----------|
| EL0037941 | Plafonieră GWEN / Ceiling lamp GWEN | 12W | 6500K | 840lm | Metal + Plastic | Alb cu model / Patterned white | 280x95mm |
| EL0037940 | | 18W | | 1260lm | | | 330x100mm |

LED 230V IP20 CCT



ERSTE

| | | | | | | | |
|-----------|-------------------------------------|-----|------------|--------|-----------------|-----------------------------|-----------|
| EL0071768 | Plafonieră HALF / Ceiling lamp HALF | 34W | 3000-6000K | 1700lm | Metal + Plastic | Alb + Negru / White + Black | 420x100mm |
|-----------|-------------------------------------|-----|------------|--------|-----------------|-----------------------------|-----------|

LED 230V IP20 CCT



ERSTE

| | | | | | | | |
|-----------|---------------------------------------|-----|------------|--------|-------------|-----------------------------|----------|
| EL0081470 | Plafonieră HORUS / Ceiling lamp HORUS | 65W | 3000-6500K | 4550lm | Metal + PVC | Alb + Negru / White + Black | 500x95mm |
|-----------|---------------------------------------|-----|------------|--------|-------------|-----------------------------|----------|



| RO | Cod | Denumire | Putere consumată | Temperatură de culoare | Flux luminos | Material | Culoare | Dimensiune |
|----|------|----------|------------------|------------------------|---------------|----------|---------|------------|
| EN | Code | Name | Power | Color temperature | Luminous flux | Material | Color | Size |

ERSTE

| | | | | | | | |
|-----------|--|------|------------|--------|----------------------------------|-------------|----------|
| EL0075431 | Plafonieră INFINITY / Ceiling lamp INFINITY | 112W | 3000-6000K | 6720lm | Metal + Acril Metal + Acrylic | Alb / White | 500x70mm |
|-----------|--|------|------------|--------|----------------------------------|-------------|----------|



ERSTE

| | | | | | | | |
|-----------|--|------|------------|--------|-------------------------------------|-------------|----------|
| EL0067630 | Plafonieră KARL / Ceiling lamp KARL | 100W | 3000-6400K | 6700lm | Metal + Acrilic/ Metal + Acrylic | Alb / White | 500x50mm |
|-----------|--|------|------------|--------|-------------------------------------|-------------|----------|



ERSTE

| | | | | | | | |
|-----------|--|-----|------------|--------|-------------|--------------------------------|----------|
| EL0081468 | Plafonieră ISIS / Ceiling lamp ISIS | 65W | 3000-6500K | 4550lm | Metal + PVC | Alb + Negru / White + Black | 480x60mm |
|-----------|--|-----|------------|--------|-------------|--------------------------------|----------|



ERSTE

| | | | | | | | |
|-----------|--|-----|-------|--------|----|-------------|----------|
| EL0075377 | Plafonieră JOLIE / Ceiling lamp JOLIE | 36W | 4000K | 4000lm | PS | Alb / White | 230x40mm |
| EL0075378 | | 48W | | 5300lm | | | 300x40mm |

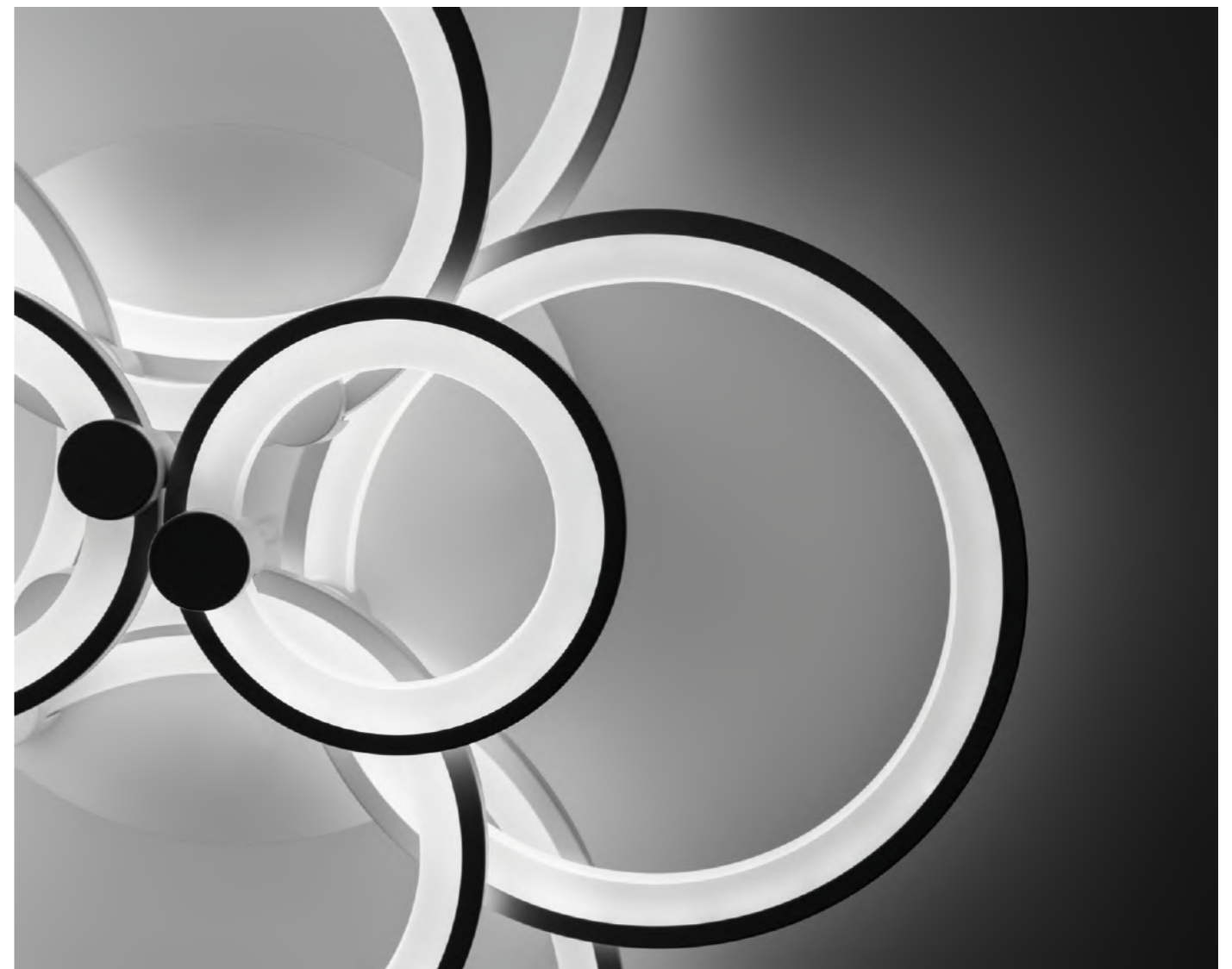

| RO | Cod | Denumire | Putere consumată | Temperatură de culoare | Flux luminos | Material | Culoare | Dimensiune |
|----|------|----------|------------------|------------------------|---------------|----------|---------|------------|
| EN | Code | Name | Power | Color temperature | Luminous flux | Material | Color | Size |

ERSTE

| | | | | | | | |
|-----------|---|------|---------------------|--------|--------------------------------------|-------------|-----------|
| EL0075383 | Plafonieră AZALIA/ Ceiling lamp AZALIA | 148W | 3000-6000K / RGB | 9620lm | Metal + Acrilic / Metal + Acrylic | Alb / White | 830x115mm |
|-----------|---|------|---------------------|--------|--------------------------------------|-------------|-----------|

LED 230V IP20



| RO | Cod | Denumire | Putere consumată | Temperatură de culoare | Flux luminos | Material | Culoare | Dimensiune |
|----|------|----------|------------------|------------------------|---------------|----------|---------|------------|
| EN | Code | Name | Power | Color temperature | Luminous flux | Material | Color | Size |

ERSTE

| | | | | | | | |
|-----------|--|-----|-------|--------|--|---------------------------------|---------------|
| EL0071579 | Plafonieră KARA / Ceiling lamp KARA | 30W | 3000K | 1800lm | Metal + Aluminiu + Acrylic / Metal + Aluminum + Acrylic | Negru + Auriu / Black + Gold | 295x149x520mm |
|-----------|--|-----|-------|--------|--|---------------------------------|---------------|

LED 230V IP20



ERSTE

| | | | | | | | |
|-----------|--|------|-------|--------|---|---------------------------------|----------|
| EL0071578 | Plafonieră KIRA / Ceiling lamp KIRA | 3x6W | 3000K | 1080lm | Metal + Aluminiu + Acrylic / Metal + Aluminum + Acrylic | Negru + Auriu / Black + Gold | 590x60mm |
| EL0071580 | | 9W | | 540lm | | | 100x92mm |

LED 230V IP20



ERSTE

| | | | | | | | |
|-----------|--|-----|-------|--------|-----------------|-----------------------------------|-----------|
| EL0037935 | Plafonieră KATE / Ceiling lamp KATE | 12W | 6500K | 840lm | Metal + Plastic | Alb cu model / Patterned white | 280x95mm |
| EL0037934 | | 18W | | 1260lm | | Alb mat / Matt white | 330x100mm |
| EL0037933 | | 24W | | 1680lm | | | 380x110mm |

LED 230V IP20 CCT



| RO | Cod | Denumire | Putere consumată | Temperatură de culoare | Flux luminos | Material | Culoare | Dimensiune |
|----|------|----------|------------------|------------------------|---------------|----------|---------|------------|
| EN | Code | Name | Power | Color temperature | Luminous flux | Material | Color | Size |

ERSTE

| | | | | | | | |
|-----------|--|-----|------------|--------|-------------------------------------|-------------|--------------|
| EL0075422 | Plafonieră LEAF / Ceiling lamp LEAF | 40W | 3000-6000K | 2800lm | Metal + Acrylic/ Metal + Acrylic | Alb / White | 475x475x85mm |
| EL0075423 | | 68W | | 4080lm | | | 580x580x85mm |

LED 230V IP20 CCT



ERSTE

| | | | | | | | |
|-----------|--------------------------------------|-----|---------------------|--------|-------------------------------------|-------------|--------------|
| EL0075387 | Plafonieră ICE / Ceiling lamp ICE | 55W | 3000-6000K / RGB | 4400lm | Metal + Acrylic/ Metal + Acrylic | Alb / White | 510x510x75mm |
|-----------|--------------------------------------|-----|---------------------|--------|-------------------------------------|-------------|--------------|

LED 230V IP20



ERSTE

| | | | | | | | |
|-----------|--|-----|-------|--------|------------|---------------|----------|
| EL0075193 | Plafonieră LIBRA / Ceiling lamp LIBRA | 26W | 4000K | 1690lm | Metal + PS | Alb / White | 400x54mm |
| EL0075192 | | | | | | Negru / Black | |



| RO | Cod | Denumire | Putere consumată | Temperatură de culoare | Flux luminos | Material | Culoare | Dimensiune |
|----|------|----------|------------------|------------------------|---------------|----------|---------|------------|
| EN | Code | Name | Power | Color temperature | Luminous flux | Material | Color | Size |

ERSTE

| | | | | | | | |
|-----------|--|-----|-------|--------|------------|---------------|----------|
| EL0075231 | Plafonieră LIND / Ceiling lamp LIND | 50W | 4000K | 3250lm | Metal + PS | Gri / Gray | 380x90mm |
| EL0075234 | | | | | | Negru / Black | |
| EL0075232 | Plafonieră LIND / Ceiling lamp LIND | 50W | 4000K | 3250lm | Metal + PS | Gri / Gray | 480x90mm |
| EL0075235 | | | | | | Negru / Black | |
| EL0075233 | Plafonieră LIND / Ceiling lamp LIND | 62W | 4000K | 3720lm | Metal + PS | Gri / Gray | 600x90mm |
| EL0075236 | | | | | | Negru / Black | |



ERSTE

| | | | | | | | |
|-----------|--|-----|-------|--------|-------------------------------|-------------|----------|
| EL0068260 | Plafonieră LOTUS / Ceiling lamp LOTUS | 34W | 6000K | 2040lm | Oțel + PMMA / Steel + PMMA | Alb / White | 470x60mm |
|-----------|--|-----|-------|--------|-------------------------------|-------------|----------|



ERSTE

| | | | | | | | |
|-----------|--|------|------------|--------|--------------------------------------|-------------|----------|
| EL0067633 | Plafonieră LYAM / Ceiling lamp LYAM | 120W | 3000-6400K | 4500lm | Metal + Acrilic / Metal + Acrylic | Alb / White | 490x40mm |
|-----------|--|------|------------|--------|--------------------------------------|-------------|----------|



| RO | Cod | Denumire | Putere consumată | Temperatură de culoare | Flux luminos | Material | Culoare | Dimensiune |
|----|------|----------|------------------|------------------------|---------------|----------|---------|------------|
| EN | Code | Name | Power | Color temperature | Luminous flux | Material | Color | Size |

ERSTE

| | | | | | | | |
|-----------|--|-----|------------|--------|--------------------------------------|-----------------|----------|
| EL0068258 | Plafonieră MACARON / Ceiling lamp MACARON | 52W | 3000-6000K | 2900lm | Metal + Acrilic / Metal + Acrylic | Alb / White | 500x50mm |
| EL0068257 | | | | | | Galben / Yellow | |



ERSTE

| | | | | | | | |
|-----------|--|-----|------------|--------|-------------|-------------------------------|--------------|
| EL0071765 | Plafonieră MAGNUS / Ceiling lamp MAGNUS | 92W | 3000-6000K | 6400lm | Metal + PVC | Alb + Auriu / White + Gold | 640x440x70mm |
|-----------|--|-----|------------|--------|-------------|-------------------------------|--------------|



ERSTE

| | | | | | | | |
|-----------|--|-----|-------|--------|--------------------------------------|---------------|----------|
| EL0071586 | Plafonieră MARS / Ceiling lamp MARS | 35W | 3000K | 1750lm | Metal + Acrilic / Metal + Acrylic | Alb / White | 420x58mm |
| EL0071585 | | | | | | Auriu / Gold | |
| EL0071584 | | | | | | Negru / Black | |



RO

EN

| Cod | Denumire | Putere consumată | Temperatură de culoare | Flux luminos | Material | Culoare | Dimensiune |
|-----|----------|------------------|------------------------|--------------|----------|---------|------------|
|-----|----------|------------------|------------------------|--------------|----------|---------|------------|

ERSTE

| Code | Name | Power | Color temperature | Luminous flux | Material | Color | Size |
|------|------|-------|-------------------|---------------|----------|-------|------|
|------|------|-------|-------------------|---------------|----------|-------|------|

| | | | | | | | |
|-----------|--|------|------------|--------|--------------|---------------|---------------|
| EL0081462 | Plafonieră MAXI / Ceiling lamp MAXI | 110W | 3000-6500K | 7700lm | Metal + PMMA | Negru / Black | 650x650x110mm |
|-----------|--|------|------------|--------|--------------|---------------|---------------|



ERSTE

| Code | Name | Power | Color temperature | Luminous flux | Material | Color | Size |
|------|------|-------|-------------------|---------------|----------|-------|------|
|------|------|-------|-------------------|---------------|----------|-------|------|

| | | | | | | | |
|-----------|--|------|------------|--------|--------------------------------------|-------------|--------------|
| EL0075435 | Plafonieră MERA / Ceiling lamp MERA | 136W | 3000-6500K | 9520lm | Metal + Acrylic / Metal + Acrylic | Alb / White | 500x430x85mm |
|-----------|--|------|------------|--------|--------------------------------------|-------------|--------------|



ERSTE

| Code | Name | Power | Color temperature | Luminous flux | Material | Color | Size |
|------|------|-------|-------------------|---------------|----------|-------|------|
|------|------|-------|-------------------|---------------|----------|-------|------|

| | | | | | | | |
|-----------|--|-----|------------|--------|---------------------------------------|--------------------------------|----------|
| EL0075178 | Plafonieră METTA / Ceiling lamp METTA | 60W | 3000-6000K | 3300lm | Metal + Silicon / Metal + Silicone | Alb + Negru / White + Black | 510x50mm |
|-----------|--|-----|------------|--------|---------------------------------------|--------------------------------|----------|



RO

EN

| Cod | Denumire | Putere consumată | Temperatură de culoare | Flux luminos | Material | Culoare | Dimensiune |
|-----|----------|------------------|------------------------|--------------|----------|---------|------------|
|-----|----------|------------------|------------------------|--------------|----------|---------|------------|

ERSTE

| Code | Name | Power | Color temperature | Luminous flux | Material | Color | Size |
|------|------|-------|-------------------|---------------|----------|-------|------|
|------|------|-------|-------------------|---------------|----------|-------|------|

| | | | | | | | |
|-----------|--------------------------------------|-----|------------|--------|---------------------------------------|--------------------------------|--------------|
| EL0075174 | | 40W | | 2200lm | | | 400x300x50mm |
| EL0075175 | Plafonieră MIA / Ceiling lamp MIA | 52W | 3000-6000K | 2860lm | Metal + Silicon / Metal + Silicone | Alb + Negru / White + Black | 510x300x55mm |
| EL0075176 | | 60W | | 3300lm | | | 610x300x52mm |



ERSTE

| Code | Name | Power | Color temperature | Luminous flux | Material | Color | Size |
|------|------|-------|-------------------|---------------|----------|-------|------|
|------|------|-------|-------------------|---------------|----------|-------|------|

| | | | | | | | |
|-----------|--|-----|-------|--------|--------------------------------------|---------------|-------------|
| EL0071583 | | | | | | Alb / White | |
| EL0071582 | Plafonieră MOON / Ceiling lamp MOON | 28W | 3000K | 1400lm | Metal + Acrylic / Metal + Acrylic | Auriu / Gold | 440x65x98mm |
| EL0071581 | | | | | | Negru / Black | |



ERSTE

| Code | Name | Power | Color temperature | Luminous flux | Material | Color | Size |
|------|------|-------|-------------------|---------------|----------|-------|------|
|------|------|-------|-------------------|---------------|----------|-------|------|

| | | | | | | | |
|-----------|--|-----|------------|--------|--------------------------------------|-------------|----------|
| EL0067921 | Plafonieră NOVA / Ceiling lamp NOVA | 92W | 3000-6400K | 4500lm | Metal + Acrylic / Metal + Acrylic | Alb / White | 480x80mm |
|-----------|--|-----|------------|--------|--------------------------------------|-------------|----------|



| RO | Cod | Denumire | Putere consumată | Temperatură de culoare | Flux luminos | Material | Culoare | Senzor de prezență | Dimensiune |
|----|------|----------|------------------|------------------------|---------------|----------|---------|-------------------------|------------|
| EN | Code | Name | Power | Color temperature | Luminous flux | Material | Color | Motion detection sensor | Size |

NOVELITE

| | | | | | | | | |
|-----------|---|-----|-------|--------|--------------|-------------|------|-----------|
| EL0071764 | Plafonieră NOVELITE / Ceiling lamp NOVELITE | 18W | 4000K | 1350lm | Metal + PMMA | Alb / White | 3-8m | 330x100mm |
|-----------|---|-----|-------|--------|--------------|-------------|------|-----------|



| RO | Cod | Denumire | Putere consumată | Temperatură de culoare | Flux luminos | Material | Culoare | Dimensiune |
|----|------|----------|------------------|------------------------|---------------|----------|---------|------------|
| EN | Code | Name | Power | Color temperature | Luminous flux | Material | Color | Size |

ERSTE

| | | | | | | | |
|-----------|-------------------------------------|-----|-------|--------|-----------------|-------------|----------|
| EL0060123 | Plafonieră ONLY / Ceiling lamp ONLY | 36W | 4000K | 2700lm | Metal + Plastic | Alb / White | 510x95mm |
|-----------|-------------------------------------|-----|-------|--------|-----------------|-------------|----------|

**ERSTE**

| | | | | | | | |
|-----------|---------------------------------------|-----|------------|--------|-----------------------------------|-------------|---------------|
| EL0075426 | Plafonieră PEARL / Ceiling lamp PEARL | 40W | 3000-6000K | 3000lm | Metal + Acrylic / Metal + Acrylic | Alb / White | 550x320x110mm |
| EL0075427 | | 52W | | 3380lm | | | 600x380x110mm |

**ERSTE**

| | | | | | | | |
|-----------|---------------------------------------|-----|------------|--------|-----------------------------------|-------------|--------------|
| EL0075420 | Plafonieră PETAL / Ceiling lamp PETAL | 48W | 3000-6000K | 3360lm | Metal + Acrylic / Metal + Acrylic | Alb / White | 500x500x80mm |
| EL0075421 | | 80W | | | | | |



| RO | Cod | Denumire | Putere consumată | Temperatură de culoare | Flux luminos | Material | Culoare | Dimensiune |
|----|------|----------|------------------|------------------------|---------------|----------|---------|------------|
| EN | Code | Name | Power | Color temperature | Luminous flux | Material | Color | Size |

ERSTE

| | | | | | | | | |
|-----------|---------------------------------------|-----|------------|--------|-----------------|----------------------------|--|----------|
| EL0075183 | | 35W | | 1925lm | | | | 400x65mm |
| EL0075184 | Plafonieră WOODY / Ceiling lamp WOODY | 45W | 3000-6000K | 2475lm | Metal + Plastic | Alb + Maro / White + Brown | | 480x70mm |
| EL0075185 | | 68W | | 3740lm | | | | 590x73mm |

**ERSTE**

| | | | | | | | |
|-----------|---|-----|-------|--------|-----------------|---------------------------|-----------|
| EL0060135 | Plafonieră RADIANCE / Ceiling lamp RADIANCE | 40W | 4000K | 2600lm | Metal + Plastic | Bej sidefat / Pearl beige | 485x130mm |
|-----------|---|-----|-------|--------|-----------------|---------------------------|-----------|

**ERSTE**

| | | | | | | | |
|-----------|---------------------------------------|-----|------------|--------|---|-----------------------------|----------|
| EL0075179 | Plafonieră RILEY / Ceiling lamp RILEY | 72W | 3000-6000K | 3960lm | Metal + acrylic + PVC / Metal + acrylic + PVC | Alb + Negru / White + Black | 490x58mm |
|-----------|---------------------------------------|-----|------------|--------|---|-----------------------------|----------|

**ERSTE**

| | | | | | | | |
|-----------|---|-----|-------|-------|---------|-------------|----------|
| EL0060129 | Plafonieră LED STAR RING / LED Ceiling lamp STAR RING | 12W | 4000K | 810lm | Plastic | Alb / White | 280x85mm |
|-----------|---|-----|-------|-------|---------|-------------|----------|

CORPURI DE ILUMINAT DECORATIVE LED | INTERIOR | PLAFONIERE



| RO | Cod | Denumire | Putere consumată | Temperatură de culoare | Flux luminos | Material | Culoare | Dimensiune |
|----|------|----------|------------------|------------------------|---------------|----------|---------|------------|
| EN | Code | Name | Power | Color temperature | Luminous flux | Material | Color | Size |

ERSTE

| | | | | | | | |
|-----------|-------------------------------------|-----|------------|--------|----------------------------------|-------------|--------------|
| EL0075434 | Plafonieră ROOF / Ceiling lamp ROOF | 96W | 3000-6000K | 5760lm | Metal + Acrlic / Metal + Acrylic | Alb / White | 500x400x70mm |
|-----------|-------------------------------------|-----|------------|--------|----------------------------------|-------------|--------------|



ERSTE

| | | | | | | | |
|-----------|-------------------------------------|-----|-------|--------|-----------------|--------------------------------|-----------|
| EL0037946 | Plafonieră ROSE / Ceiling lamp ROSE | 18W | 6500K | 1260lm | Metal + Plastic | Alb cu model / Patterned white | 330x100mm |
| EL0037945 | | 24W | | 1680lm | | | 380x110mm |



ERSTE

| | | | | | | | |
|-----------|---|-----|-------|--------|-----------------|------------------------------------|----------|
| EL0060136 | Plafonieră ROUNDWOOD / Ceiling lamp ROUNDWOOD | 36W | 4000K | 2000lm | Plastic + Metal | Alb + Natur / White + Natural wood | 490x70mm |
| EL0060121 | | 24W | | 1800lm | | | 390x75mm |



ERSTE

| | | | | | | | |
|-----------|---------------------------------------|-----|------------------|--------|----------------------------------|-------------|-----------|
| EL0075385 | Plafonieră SHINE / Ceiling lamp SHINE | 98W | 3000-6000K / RGB | 7840lm | Metal + Acrlic / Metal + Acrylic | Alb / White | 650x120mm |
|-----------|---------------------------------------|-----|------------------|--------|----------------------------------|-------------|-----------|

LED DECORATIVE LIGHTING FIXTURES | INDOOR | CEILING LAMPS



| RO | Cod | Denumire | Putere consumată | Temperatură de culoare | Flux luminos | Material | Culoare | Dimensiune |
|----|------|----------|------------------|------------------------|---------------|----------|---------|------------|
| EN | Code | Name | Power | Color temperature | Luminous flux | Material | Color | Size |

ERSTE

| | | | | | | | |
|-----------|-------------------------------------|-----|-------|--------|-----|-------------|----------|
| EL0075373 | Plafonieră SLIM / Ceiling lamp SLIM | 24W | 4000K | 2040lm | ABS | Alb / White | 230x20mm |
| EL0075374 | | 28W | | 2380lm | | | 300x20mm |
| EL0075375 | | 38W | | 3230lm | | | 400x20mm |
| EL0075376 | | 48W | | 4080lm | | | 500x20mm |



ERSTE

| | | | | | | | |
|-----------|---------------------------------------|-----|------------|--------|-----------------|-----------------------------|--------------|
| EL0071771 | Plafonieră SNAIL / Ceiling lamp SNAIL | 45W | 3000-6000K | 2100lm | Metal + Plastic | Alb + Negru / White + Black | 420x350x50mm |
|-----------|---------------------------------------|-----|------------|--------|-----------------|-----------------------------|--------------|



ERSTE

| | | | | | | | |
|-----------|---------------------------------------|-----|------------|--------|-----------------|---------------|-----------|
| EL0081469 | Plafonieră SOBEK / Ceiling lamp SOBEK | 45W | 3000-6500K | 3850lm | Metal + Plastic | Negru / Black | 600x105mm |
|-----------|---------------------------------------|-----|------------|--------|-----------------|---------------|-----------|



ERSTE

| | | | | | | | |
|-----------|---------------------------------------|------|------------|--------|----------------------------------|-------------|--------------|
| EL0075353 | Plafonieră SONNE / Ceiling lamp SONNE | 110W | 2800-6500K | 7150lm | Metal + Acrlic / Metal + Acrylic | Alb / White | 545x545x70mm |
|-----------|---------------------------------------|------|------------|--------|----------------------------------|-------------|--------------|

LED 230V IP20



| RO | Cod | Denumire | Putere consumată | Temperatură de culoare | Flux luminos | Material | Culoare | Dimensiune |
|----|------|----------|------------------|------------------------|---------------|----------|---------|------------|
| EN | Code | Name | Power | Color temperature | Luminous flux | Material | Color | Size |

ERSTE

| | | | | | | | | |
|-----------|--|--|-----|-------|--------|-------------|-------------|----------|
| EL0075730 | | | 12W | | 850lm | | | 260x45mm |
| EL0075731 | Plafonieră SPRING / Ceiling lamp SPRING | | 18W | 4000K | 1000lm | Metal + PVC | Alb / White | 345x65mm |
| EL0075732 | | | 24W | | 1550lm | | | 395x65mm |
| EL0075733 | | | 36W | | 2340lm | | | 485x70mm |

LED 230V IP20

**ERSTE**

| | | | | | | | |
|-----------|--|-----|-------|--------|-----------------|---------------------------------------|----------|
| EL0060122 | Plafonieră SQUAREWOOD / Ceiling lamp SQUAREWOOD | 36W | 4000K | 1700lm | Metal + Plastic | Alb + Natur / White + Natural wood | 480x60mm |
|-----------|--|-----|-------|--------|-----------------|---------------------------------------|----------|

LED 230V IP20 CCT

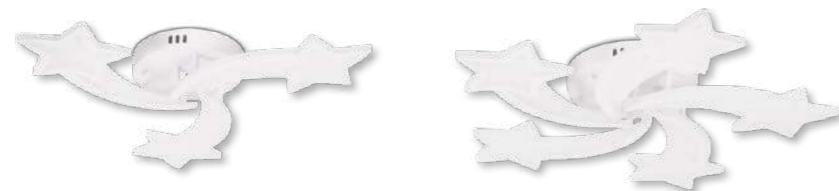
**ERSTE**

| | | | | | | | |
|-----------|--|-----|------------|--------|------------------------------------|-------------|--------------|
| EL0075418 | Plafonieră STAR / Ceiling lamp STAR | 52W | 3000-6000K | 3380lm | Metal + Acrylic Metal + Acrylic | Alb / White | 520x520x90mm |
| EL0075419 | | 86W | | 5590lm | | | 720x720x90mm |

LED 230V IP20



| RO | Cod | Denumire | Putere consumată | Temperatură de culoare | Flux luminos | Material | Culoare | Dimensiune |
|----|------|----------|------------------|------------------------|---------------|----------|---------|------------|
| EN | Code | Name | Power | Color temperature | Luminous flux | Material | Color | Size |

ERSTE

| | | | | | | | | |
|-----------|--|-----|-------|--------|------------------------------------|-------------------------------------|-------------|--------------|
| EL0071589 | | | | | | | Alb / White | 420x65x100mm |
| EL0071588 | Plafonieră YUMO / Ceiling lamp YUMO | 36W | 4000K | 1980lm | Metal + Acrylic Metal + Acrylic | Auriu + Argintiu / Gold + Silver | | |
| EL0071587 | | | | | | Negru / Black | | |

LED 230V IP20

**ERSTE**

| | | | | | | | |
|-----------|--|-----|-------|--------|-----------------------------|-------------|----------|
| EL0068259 | Plafonieră SUNNY / Ceiling lamp SUNNY | 28W | 6000K | 1680lm | Oțel + PMMA Steel + PMMA | Alb / White | 500x95mm |
|-----------|--|-----|-------|--------|-----------------------------|-------------|----------|

LED 230V IP20

**ERSTE**

| | | | | | | | |
|-----------|--|-----|-------|--------|-----------------|-------------|----------|
| EL0060125 | Plafonieră TERRA / Ceiling lamp TERRA | 36W | 4000K | 2700lm | Metal + Plastic | Alb / White | 500x80mm |
|-----------|--|-----|-------|--------|-----------------|-------------|----------|



RO

EN

| Cod | Denumire | Putere consumată | Temperatură de culoare | Flux luminos | Material | Culoare | Dimensiune |
|-----------|---------------------------------------|------------------|------------------------|--------------|-----------------------------------|-------------|--------------|
| EL0075386 | Plafonieră TETRA / Ceiling lamp TETRA | 60W | 3000-6000K / RGB | 4500lm | Metal + Acrlic Metal + Acrylic | Alb / White | 390x390x70mm |

ERSTE**ERSTE**

| EL0060119 | Plafonieră TILES / Ceiling lamp TILES | 24W | 4000K | 1682lm | Metal + Plastic | Alb / White | 385x65mm |
|-----------|---------------------------------------|-----|-------|--------|-----------------|-------------|----------|
| EL0060134 | | 40W | | 2500lm | | | 485x60mm |

**ERSTE**

| EL0075350 | Plafonieră TIRE / Ceiling lamp TIRE | 55W | 3000-6000K | 4400lm | Metal + Acrlic Metal + Acrylic | Alb / White | 580x420x95mm |
|-----------|-------------------------------------|-----|------------|--------|-----------------------------------|-------------|--------------|
|-----------|-------------------------------------|-----|------------|--------|-----------------------------------|-------------|--------------|

**ERSTE**

| EL0081471 | Plafonieră TOHT / Ceiling lamp TOHT | 70W | 3000-4000-6500K | 5250lm | Metal + Plastic | Negru / Black | 510x50mm |
|-----------|-------------------------------------|-----|-----------------|--------|-----------------|---------------|----------|
|-----------|-------------------------------------|-----|-----------------|--------|-----------------|---------------|----------|



RO

EN

| Cod | Denumire | Putere consumată | Temperatură de culoare | Flux luminos | Material | Culoare | Dimensiune |
|-----------|-------------------------------------|------------------|------------------------|--------------|------------|----------------------------|------------|
| EL0075197 | Plafonieră TRIM / Ceiling lamp TRIM | 30W | 3000-6500K | 1500lm | Metal + PS | Negru+Auriu/ Black+Gold | 420x350mm |

ERSTE**ERSTE**

| EL0060118 | Plafonieră VENUS / Ceiling lamp VENUS | 24W | 4000K | 1680lm | Metal + Plastic | Alb + Gri / White + Gray | 456x65mm |
|-----------|---------------------------------------|-----|-------|--------|-----------------|-----------------------------|----------|
|-----------|---------------------------------------|-----|-------|--------|-----------------|-----------------------------|----------|

**ERSTE**

| EL0081467 | Plafonieră VISTA / Ceiling lamp VISTA | 38W | 3000-6000K | 2660lm | Metal + PVC | Negru / Black | 260x190x50mm |
|-----------|---------------------------------------|-----|------------|--------|-------------|---------------|--------------|
|-----------|---------------------------------------|-----|------------|--------|-------------|---------------|--------------|



RO

| Cod | Denumire | Putere consumată | Temperatură de culoare | Flux luminos | Material | Culoare | Dimensiune |
|-----|----------|------------------|------------------------|--------------|----------|---------|------------|
|-----|----------|------------------|------------------------|--------------|----------|---------|------------|

EN

| Code | Name | Power | Color temperature | Luminous flux | Material | Color | Size |
|------|------|-------|-------------------|---------------|----------|-------|------|
|------|------|-------|-------------------|---------------|----------|-------|------|

HOMELIGHT

| | | | | | | | |
|-----------|-----------------------------------|-----|-------|--------|-------------------|-------------|----------|
| EL0040029 | Plafonieră LED / LED Ceiling lamp | 12W | 6400K | 1000lm | Acrilic / Acrylic | Alb / White | 255x90mm |
|-----------|-----------------------------------|-----|-------|--------|-------------------|-------------|----------|



HOMELIGHT

| | | | | | | | |
|-----------|-----------------------------------|-----|-------|--------|-----------------|-------------|----------|
| EL0060807 | Plafonieră LED / LED Ceiling lamp | 18W | 4000K | 1260lm | Metal + Plastic | Alb / White | 335x64mm |
|-----------|-----------------------------------|-----|-------|--------|-----------------|-------------|----------|



HOMELIGHT

| | | | | | | | |
|-----------|-----------------------------------|-----|-------|--------|-----------------|-------------|----------|
| EL0081064 | | 25W | | 2375lm | | | 270x60mm |
| EL0081065 | Plafonieră LED / LED Ceiling lamp | 15W | 6500K | 1575lm | Metal + Plastic | Alb / White | 270x60mm |
| EL0081066 | | 22W | 4000K | 1680lm | | | 330x55mm |



DECORATIVE LIGHTING FIXTURES

SOURCES

SMART HOME

SWITCHES AND SOCKETS

CONNECTORS

POWER AUTOMATION

TECHNICAL LIGHTNING FIXTURES

CABLE MANAGEMENT SYSTEMS

CABLES

LED 230V IP20 CCT



| RO | Cod | Denumire | Putere consumată | Temperatură de culoare | Flux luminos | Material | Culoare | Dimensiune |
|----|------|----------|------------------|------------------------|---------------|----------|---------|------------|
| EN | Code | Name | Power | Color temperature | Luminous flux | Material | Color | Size |

HOMELIGHT

| | | | | | | | |
|-----------|--|-----|-------|--------|-----------|-------------|----------|
| EL0085838 | Plafonieră HL-A1 / Ceiling lamp HL-A1 | 23W | 6500K | 3105lm | ABS+PP+PS | Alb / White | 180x40mm |
|-----------|--|-----|-------|--------|-----------|-------------|----------|

LED 230V IP20

**HOMELIGHT**

| | | | | | | | |
|-----------|--|-----|-------|--------|-----------|-------------|--------------|
| EL0085839 | Plafonieră HL-A2 / Ceiling lamp HL-A2 | 23W | 6500K | 3105lm | ABS+PP+PS | Alb / White | 180x180x40mm |
|-----------|--|-----|-------|--------|-----------|-------------|--------------|

LED 230V IP20 CCT

**HOMELIGHT**

| | | | | | | | |
|-----------|--|-----|---------------------|--------|-----------------|-------------|----------|
| EL0085844 | Plafonieră HL-A5 / Ceiling lamp HL-A5 | 38W | 3000-4000- 6500K | 3230lm | Metal + Plastic | Alb / White | 380x50mm |
|-----------|--|-----|---------------------|--------|-----------------|-------------|----------|

LED 230V IP20 CCT



| RO | Cod | Denumire | Putere consumată | Temperatură de culoare | Flux luminos | Material | Culoare | Dimensiune |
|----|------|----------|------------------|------------------------|---------------|----------|---------|------------|
| EN | Code | Name | Power | Color temperature | Luminous flux | Material | Color | Size |

HOMELIGHT

| | | | | | | | |
|-----------|--|-----|---------------------|--------|-----------------|-------------|----------|
| EL0085845 | Plafonieră HL-A6 / Ceiling lamp HL-A6 | 22W | 3000-4000- 6500K | 2300lm | Metal + Plastic | Alb / White | 375x75mm |
|-----------|--|-----|---------------------|--------|-----------------|-------------|----------|

LED 230V IP20 CCT

**HOMELIGHT**

| | | | | | | | |
|-----------|--|-----|---------------------|--------|-----------------|-------------|----------|
| EL0085846 | Plafonieră HL-A7 / Ceiling lamp HL-A7 | 22W | 3000-4000- 6500K | 2600lm | Metal + Plastic | Alb / White | 395x70mm |
|-----------|--|-----|---------------------|--------|-----------------|-------------|----------|

LED 230V IP20 CCT

**HOMELIGHT**

| | | | | | | | |
|-----------|--|-----|------------|--------|------------|-------------|----------|
| EL0085851 | Plafonieră HL-A9 / Ceiling lamp HL-A9 | 25W | 3000-7000K | 2450lm | Metal + PS | Alb / White | 270x75mm |
|-----------|--|-----|------------|--------|------------|-------------|----------|

LED 230V IP44



RO

| Cod | Denumire | Putere consumată | Temperatură de culoare | Flux luminos | Material | Culoare | Dimensiune |
|-----|----------|------------------|------------------------|--------------|----------|---------|------------|
|-----|----------|------------------|------------------------|--------------|----------|---------|------------|

EN

| Code | Name | Power | Color temperature | Luminous flux | Material | Color | Size |
|------|------|-------|-------------------|---------------|----------|-------|------|
|------|------|-------|-------------------|---------------|----------|-------|------|

ERSTE

| | | | | | | | |
|-----------|--|-----|-------|-------|---------------------------------|---------------|--------------|
| EL0075205 | Plafonieră WALLY / Ceiling lamp WALLY | 9W | 6000K | 540lm | Aluminiu + PC Aluminium + PC | Alb / White | 400x195x30mm |
| EL0075206 | | 12W | | 780lm | | | 500x195x30mm |
| EL0075207 | | 14W | | 840lm | | | 600x195x30mm |
| EL0075203 | Plafonieră PICTURE / Ceiling lamp PICTURE | 9W | 4000K | 540lm | | Negru / Black | 395x115x35mm |
| EL0075204 | | 12W | | 720lm | | | 495x115x35mm |



LED 230V IP44

ERSTE

| | | | | | | | |
|-----------|--|-----|-------|--------|-------------------------------|-------------|----------|
| EL0068261 | Plafonieră JYMNY Ceiling lamp JYMNY | 23W | 6000K | 1752lm | Oțel + PMMA / Steel + PMMA | Alb / White | 300x24mm |
| EL0068262 | | 32W | | 2430lm | | | 400x24mm |



LED 230V IP44

ERSTE

| | | | | | | | |
|-----------|--|-----|-------|--------|-----------------------------|----------------------|-------------|
| EL0075201 | Plafonieră BATH / Ceiling lamp BATH | 12W | 6000K | 900lm | Al + PC / Aluminium + PC | Argintiu / Silver | 505x65x40mm |
| EL0075202 | | 14W | | 1120lm | | Negru / Black | 605x65x40mm |

LED 230V IP44



RO

| Cod | Denumire | Putere consumată | Temperatură de culoare | Flux luminos | Material | Culoare | Dimensiune |
|-----|----------|------------------|------------------------|--------------|----------|---------|------------|
|-----|----------|------------------|------------------------|--------------|----------|---------|------------|

EN

| Code | Name | Power | Color temperature | Luminous flux | Material | Color | Size |
|------|------|-------|-------------------|---------------|----------|-------|------|
|------|------|-------|-------------------|---------------|----------|-------|------|

ERSTE

| | | | | | | | |
|-----------|--|-----|-------|--------|---------|-------------|----------|
| EL0060126 | Plafonieră STARLIGHT / Ceiling lamp STARLIGHT | 12W | 4000K | 810lm | Plastic | Alb / White | 270x85mm |
| EL0060127 | | 18W | | 1400lm | | | 370x85mm |



LED 230V IP20

NOVELITE

| | | | | | | | |
|-----------|--------------------------------------|-----|-------|--------|-----------------|-------------------------|-----------|
| EL0036447 | | 15W | 6500K | 1050lm | | | 280x95mm |
| EL0036448 | | | 2700K | | | | |
| EL0036449 | Plafonieră LED / LED ceiling lamp | 18W | 6500K | 1260lm | Metal + Plastic | Alb mat / Matt white | 330x100mm |
| EL0036450 | | | 2700K | | | | |
| EL0036452 | | 24W | 2700K | 1680lm | | | 380x110mm |
| EL0036454 | | | 6500K | | | | |



APLICE INTERIOR LED

INDOOR LED WALL LAMPS

RO

Aplicele LED sunt soluții elegante și eficiente pentru iluminatul ambiental sau decorativ, oferind un consum redus de energie și o lumină de calitate superioară.

REPERE

- Iluminare direcționată – lumină focalizată sau difuză, adaptată nevoilor;
- Design variat – disponibile în multiple stiluri pentru integrare armonioasă;
- Tehnologie LED – consum redus și durată de viață extinsă.

EN

LED wall lights are elegant and efficient solutions for ambient or decorative lighting, providing low energy consumption and superior light quality.

FEATURES

- Directional lighting – focused or diffused light, adapted to various needs;
- Varied designs – available in multiple styles for seamless integration;
- LED technology – low power consumption and extended lifespan.

LED 230V IP20 CCT



| RO | Cod | Denumire | Putere consumată | Temperatură de culoare | Flux luminos | Material | Culoare | Dimensiune |
|--------------|-----------|--------------------------------|------------------|------------------------|---------------|------------------------------------|-------------|--------------|
| EN | Code | Name | Power | Color temperature | Luminous flux | Material | Color | Size |
| ERSTE | | | | | | | | |
| | EL0075390 | Aplică AGATA / Wall lamp AGATA | 12W | 3000-6000K | 900lm | Metal + Acrylic Metal + Acrylic | Alb / White | 230x170x45mm |

LED 230V IP20 CCT



| | | | | | | | | |
|--------------|-----------|------------------------------|-----|------------|--------|--|-------------|--------------|
| ERSTE | | | | | | | | |
| | EL0075416 | Aplică ARIA / Wall lamp ARIA | 28W | 3000-6000K | 1820lm | Aluminiu + Silicon Aluminium + Silicone | Alb / White | 330x260x90mm |

LED 230V IP20 CCT



| | | | | | | | | |
|--------------|-----------|----------------------------------|-----|------------|--------|--|-------------|--------------|
| ERSTE | | | | | | | | |
| | EL0075417 | Plafonieră ANNA / Wall lamp ANNA | 28W | 3000-6000K | 1820lm | Aluminiu + Silicon Aluminium + Silicone | Alb / White | 285x175x90mm |

LED 230V IP20 CCT



| | | | | | | | | |
|--------------|-----------|--------------------------------|-----|------------|--------|------------------------------------|---------------|---------------|
| ERSTE | | | | | | | | |
| | EL0075425 | Aplică PEARL / Wall lamp PEARL | 30W | 3000-6500K | 1650lm | Metal + Acrylic Metal + Acrylic | Negru / Black | 410x250x115mm |



| RO | Cod | Denumire | Putere consumată | Temperatură de culoare | Flux luminos | Material | Culoare | Dimensiune |
|----|------|----------|------------------|------------------------|---------------|----------|---------|------------|
| EN | Code | Name | Power | Color temperature | Luminous flux | Material | Color | Size |

ERSTE

| | | | | | | | |
|-----------|-----------------------------------|-----|------------|--------|------------------------------------|---------------|---------------|
| EL0075428 | Aplică MARGO / Wall lamp MARGO | 40W | 3000-6500K | 2200lm | Metal + Acrylic Metal + Acrylic | Negru / Black | 510x330x110mm |
|-----------|-----------------------------------|-----|------------|--------|------------------------------------|---------------|---------------|

**ERSTE**

| | | | | | | | |
|-----------|---------------------------------|-----|------------|--------|------------------------------------|-------------|-----------|
| EL0081474 | Aplică ODIN / Wall lamp ODIN | 25W | 3000-6500K | 2500lm | Metal + Acrylic Metal + Acrylic | Alb / White | 260x290mm |
|-----------|---------------------------------|-----|------------|--------|------------------------------------|-------------|-----------|

**ERSTE**

| | | | | | | | |
|-----------|-----------------------------------|-----|------------|--------|------------------------------------|-------------|-----------|
| EL0081475 | Aplică SKADI / Wall lamp SKADI | 25W | 3000-6500K | 2500lm | Metal + Acrylic Metal + Acrylic | Alb / White | 195x230mm |
|-----------|-----------------------------------|-----|------------|--------|------------------------------------|-------------|-----------|

**ERSTE**

| | | | | | | | |
|-----------|---------------------------------|-----|------------|--------|------------------------------------|-------------|-----------|
| EL0081476 | Aplică LOKI / Wall lamp LOKI | 16W | 3000-6500K | 1360lm | Metal + Acrylic Metal + Acrylic | Alb / White | 190x260mm |
|-----------|---------------------------------|-----|------------|--------|------------------------------------|-------------|-----------|



| RO | Cod | Denumire | Putere consumată | Temperatură de culoare | Flux luminos | Material | Culoare | Dimensiune |
|----|------|----------|------------------|------------------------|---------------|----------|---------|------------|
| EN | Code | Name | Power | Color temperature | Luminous flux | Material | Color | Size |

ERSTE

| | | | | | | | |
|-----------|-------------------------------------|-----|------------|--------|-------|--------------|-----------|
| EL0081477 | Aplică ZENITH / Wall lamp ZENITH | 24W | 3000-6500K | 1680lm | Metal | Auriu / Gold | 160x400mm |
|-----------|-------------------------------------|-----|------------|--------|-------|--------------|-----------|

**ERSTE**

| | | | | | | | |
|-----------|-------------------------------------|-----|------------|--------|------------------------------------|---------------|-----------|
| EL0081478 | Aplică ZULEYA / Wall lamp ZULEYA | 24W | 3000-6500K | 1680lm | Metal + Acrylic Metal + Acrylic | Negru / Black | 155x400mm |
|-----------|-------------------------------------|-----|------------|--------|------------------------------------|---------------|-----------|

**HOMELIGHT**

| | | | | | | | |
|-----------|-------------------------------|-----|-------|--------|-----------------|-------------|----------|
| EL0081062 | Aplică LED / Wall lamp LED | 18W | 6400K | 1530lm | Metal + Plastic | Alb / White | 119x42mm |
| EL0081063 | | 24W | | 2040lm | | | 167x42mm |



PENDULE INTERIOR LED

INDOOR LED PENDANTS

RO

Pendulele LED sunt corpuri de iluminat moderne și eficiente, potrivite pentru livinguri, bucătării sau spații comerciale, oferind un echilibru între design și performanță energetică.

REPERE

- **Design rafinat** – disponibile în diverse stiluri și finisaje;
- **Iluminare focalizată** – tehnologie LED pentru eficiență maximă;
- **Montaj simplu** – ușor de instalat și adaptabil diverselor configurații.

EN

LED pendant lights are modern and efficient lighting solutions, suitable for living rooms, kitchens, or commercial spaces, offering a perfect balance between design and energy performance.

FEATURES

- **Refined design** – available in various styles and finishes;
- **Focused lighting** – LED technology for maximum efficiency;
- **Simple installation** – easy to mount and adaptable to various configurations.



| RO | Cod | Denumire | Putere consumată | Temperatură de culoare | Flux luminos | Material | Culoare | Dimensiune |
|--------------|-----------|------------------------------------|------------------|------------------------|---------------|---|--------------|----------------|
| EN | Code | Name | Power | Color temperature | Luminous flux | Material | Color | Size |
| ERSTE | | | | | | | | |
| | EL0071773 | Pendul COCKTAIL / Pendant COCKTAIL | 52W | 2700-5400K | 2940lm | Aluminiu + Silicon / Aluminium + Silicone | Auriu / Gold | 1000x290x750mm |

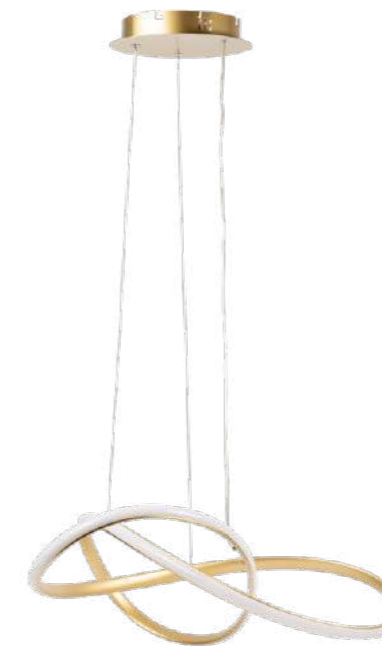

| | | | | | | | | |
|--------------|-----------|------------------------------|-----|------------|--------|---|--------------|----------------|
| ERSTE | | | | | | | | |
| | EL0075196 | Pendul LIBRA / Pendant LIBRA | 40W | 3000-6500K | 2560lm | Aluminiu + Silicon / Aluminium + Silicone | Auriu / Gold | 1500x600x180mm |

LED 230V IP20

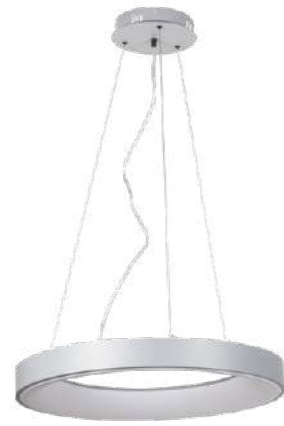

| RO | Cod | Denumire | Putere consumată | Temperatură de culoare | Flux luminos | Material | Culoare | Dimensiune |
|----|------|----------|------------------|------------------------|---------------|----------|---------|------------|
| EN | Code | Name | Power | Color temperature | Luminous flux | Material | Color | Size |

ERSTE

| | | | | | | | |
|-----------|-------------------------------|-----|-------|--------|------------|------------|---------------|
| EL0075237 | Pendul LIND / Pendant LIND | 65W | 4000K | 3900lm | Metal + PS | Gri / Gray | 1500x600x90mm |
|-----------|-------------------------------|-----|-------|--------|------------|------------|---------------|



LED 230V IP20 CCT

ERSTE

| | | | | | | | |
|-----------|---------------------------------|------|------------|--------|--------------------------------------|-------------------|----------------|
| EL0075424 | Pendul STYLE / Pendant STYLE | 140W | 3000-6000K | 8400lm | Metal + Acrylic / Metal + Acrylic | Argintiu / Silver | 1000x400x350mm |
|-----------|---------------------------------|------|------------|--------|--------------------------------------|-------------------|----------------|



LED 230V IP20 CCT

HOMELIGHT

| | | | | | | | |
|-----------|-----------------------------------|-----|-------|--------|----------|---------------|-----------|
| EL0085848 | Pendul HL-A10 / Pendant HL-A10 | 10W | 6500K | 1200lm | ABS + PS | Negru / Black | 145X115mm |
|-----------|-----------------------------------|-----|-------|--------|----------|---------------|-----------|

LED 230V IP20 CCT



| RO | Cod | Denumire | Putere consumată | Temperatură de culoare | Flux luminos | Material | Culoare | Dimensiune |
|----|------|----------|------------------|------------------------|---------------|----------|---------|------------|
| EN | Code | Name | Power | Color temperature | Luminous flux | Material | Color | Size |

ERSTE

| | | | | | | | |
|-----------|---------------------------------|-----|---------------------|--------|-----------------|---------------|----------------|
| EL0081480 | Pendul HADES / Pendant HADES | 34W | 3000-4000- 6000K | 2380lm | Metal + Plastic | Negru / Black | 1200x60x1500mm |
|-----------|---------------------------------|-----|---------------------|--------|-----------------|---------------|----------------|

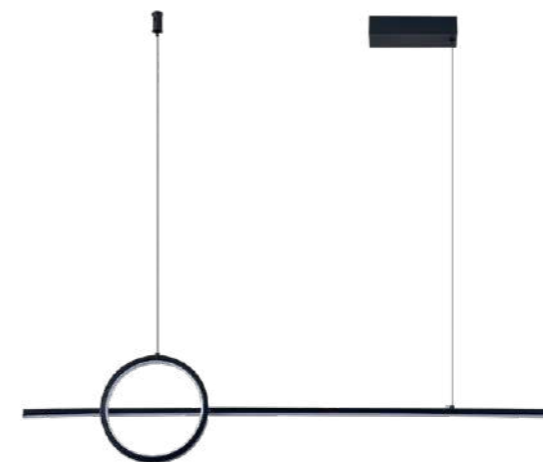

LED 230V IP20

ERSTE

| | | | | | | | |
|-----------|-------------------------------|-----|------------|--------|-------|---------------|-------------|
| EL0081479 | Pendul HERA / Pendant HERA | 40W | 3000-6500K | 2800lm | Metal | Negru / Black | 1000x1000mm |
|-----------|-------------------------------|-----|------------|--------|-------|---------------|-------------|

LED 230V IP20



| RO | Cod | Denumire | Putere consumată | Temperatură de culoare | Flux luminos | Material | Culoare | Dimensiune |
|--------------|-----------|-----------------------------------|------------------|------------------------|---------------|----------------------|-------------|------------|
| EN | Code | Name | Power | Color temperature | Luminous flux | Material | Color | Size |
| ERSTE | | | | | | | | |
| | EL0038468 | Lustră WONDER / Chandelier WONDER | 96W | 4000K | 7680lm | Aluminiu / Aluminium | Alb / White | 1200x800mm |

LED 230V IP20 CCT



| | | | | | | | | |
|--------------|-----------|-------------------------------|-----|------------|--------|---|--------------|------------|
| ERSTE | | | | | | | | |
| | EL0071774 | Lustră HALO / Chandelier HALO | 60W | 2700-5400K | 3300lm | Aluminiu + Silicon / Aluminium + Silicone | Auriu / Gold | 1000x600mm |

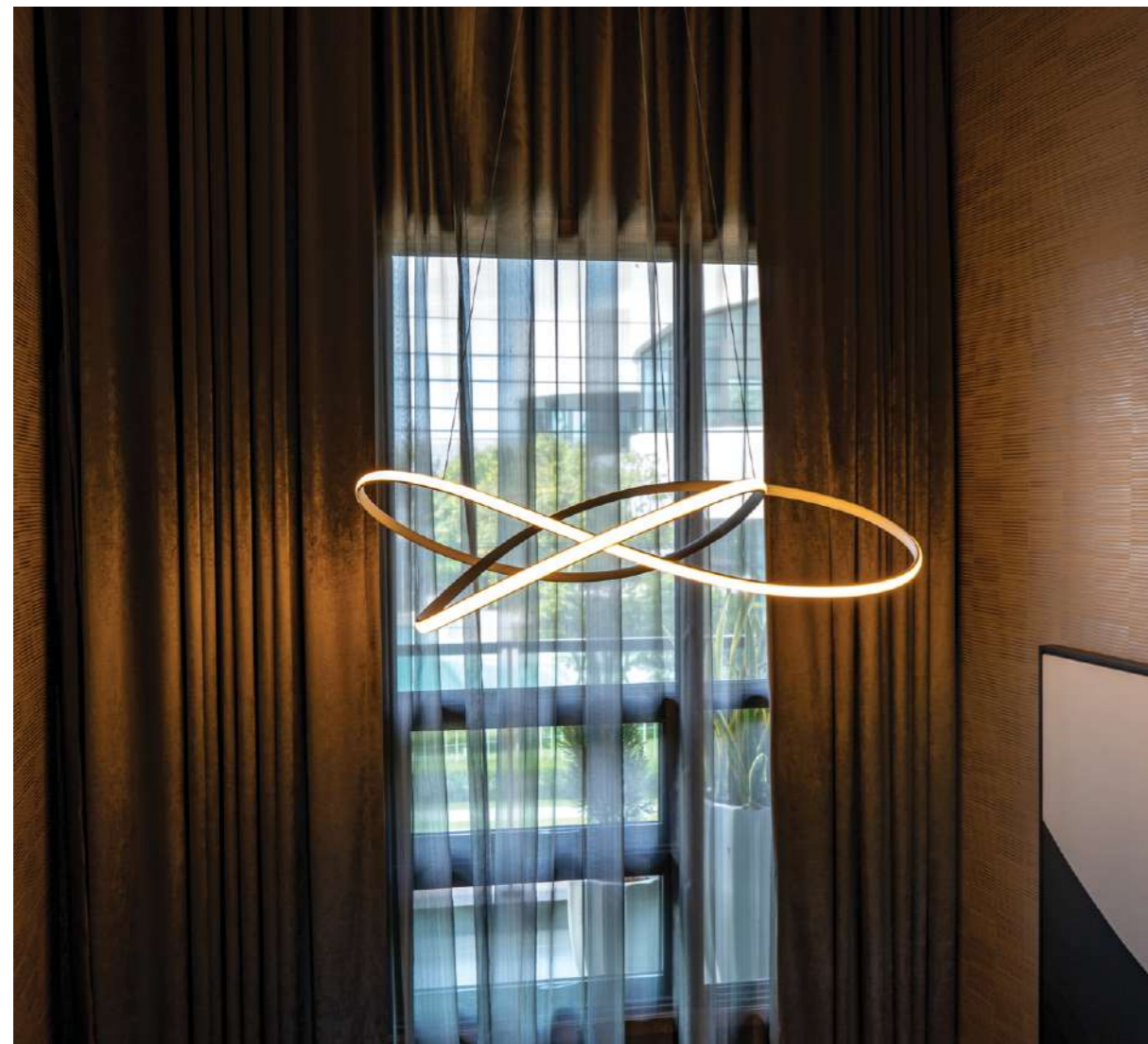

LUSTRE INTERIOR LED

INDOOR LED CHANDELIER

RO

Lustrele LED sunt corpuri de iluminat elegante și eficiente, ideale pentru a adăuga rafinament și eficiență energetică în orice interior.

REPERE

- Aspect sofisticat – perfecte pentru interioare elegante și luxoase;
- Iluminare amplă și uniformă – distribuție eficientă a luminii LED;
- Modele variate – disponibile în diferite dimensiuni și stiluri.

EN

LED chandeliers are elegant and efficient lighting fixtures, ideal for adding energy efficiency to any interior.

FEATURES

- Sophisticated appearance – ideal for elegant and luxurious interiors;
- Wide and uniform illumination – efficient LED light distribution;
- Varied models – available in different sizes and styles.



RO

EN

| Cod | Denumire | Putere consumată | Temperatură de culoare | Flux luminos | Material | Culoare | Dimensiune |
|--------------|-----------------------------|------------------|------------------------|---------------|-----------------------------------|--------------|---------------|
| Code | Name | Power | Color temperature | Luminous flux | Material | Color | Size |
| ERSTE | | | | | | | |
| EL0075198 | Lustră ORO / Chandelier ORO | 45W | 3500-6000K | 2700lm | Metal + Acrylic / Metal + Acrylic | Auriu / Gold | 500x390x110mm |
| EL0075199 | | 52W | | 3120lm | | | 560x410x90mm |

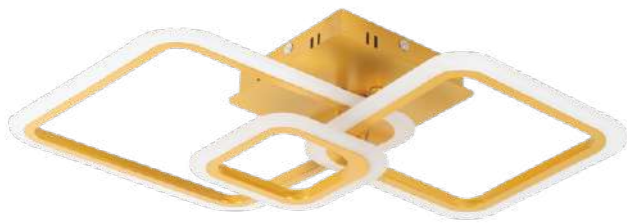

| | | | | | | | |
|--------------|-----------------------------|-----|------------|--------|-----------------------------------|------------------------|---------------|
| ERSTE | | | | | | | |
| EL0075200 | Lustră ROW / Chandelier ROW | 56W | 3500-6000K | 3360lm | Metal + Acrylic / Metal + Acrylic | Auriu+Alb / Gold+White | 620x410x110mm |





VEIOZE LED LED LAMPS

RO

Lămpile LED sunt soluții versatile pentru iluminat, perfecte pentru crearea unei atmosfere plăcute în orice spațiu, combinând designul modern cu eficiența energetică.

REPERE

- **Versatilitate** – ideale pentru iluminatul ambiental sau accentuat;
- **Tehnologie LED** – consum redus și performanță îndelungată;
- **Design variat** – disponibile în stiluri clasice și moderne.

EN

LED lamps are versatile lighting solutions, ideal for creating a pleasant atmosphere in any space, blending modern design with energy efficiency.

FEATURES

- **Versatility** – suitable for ambient or accent lighting.
- **LED technology** – low consumption and long-lasting performance.
- **Varied designs** – available in both classic and modern styles.



| RO | Cod | Denumire | Putere consumată | Temperatură de culoare | Flux luminos | Material | Culoare | Dimensiune |
|----|------|----------|------------------|------------------------|---------------|----------|---------|------------|
| EN | Code | Name | Power | Color temperature | Luminous flux | Material | Color | Size |

ERSTE

| | | | | | | | |
|-----------|--------------------------|----|-----------------|-------|-------|---------------|-----------|
| EL0081489 | Veioză HOLD / lamps HOLD | 5W | 3000-4000-6000K | 200lm | Metal | Negru / Black | 390x100mm |
| EL0081490 | | | | | | Alb / White | |

i Veiozele HOLD sunt reîncărcabile și conțin un cablu USB de 80 cm.
HOLD lamps are rechargeable and include an 80 cm USB cable.



ERSTE

| | | | | | | | |
|-----------|-------------------------------------|----|-----------------|-------|-----|-------------|-------------|
| EL0081488 | Lampă birou MISHE / Desk lamp MISHE | 3W | 3000-4000-6000K | 150lm | ABS | Alb / White | 97x98x345mm |
|-----------|-------------------------------------|----|-----------------|-------|-----|-------------|-------------|

i Veiozele MISHE sunt reîncărcabile și conțin un cablu USB de 100 cm.
MISHE lamps are rechargeable and include a 100 cm USB cable.



ERSTE

| | | | | | | | |
|-----------|-----------------------------------|----|-----------------|-------|----|-------------|--------------|
| EL0081487 | Lampă birou JAFF / Desk lamp JAFF | 5W | 3000-4000-6000K | 200lm | PP | Alb / White | 260x85x285mm |
|-----------|-----------------------------------|----|-----------------|-------|----|-------------|--------------|

i Veiozele JAFF sunt reîncărcabile și conțin un cablu USB de 80 cm.
JAFF lamps are rechargeable and include an 80 cm USB cable.



LĂMPI VEGHE LED

LED NIGHT LIGHTS

RO

Lămpile de veghe LED asigură un iluminat discret și reconfortant pe timpul nopții, fiind ideale pentru dormitoare și camerele copiilor.

REPERE

- Lumină blândă – perfectă pentru un somn odihnitor;
- Consum minim de energie – tehnologie LED eficientă pentru utilizare îndelungată;
- Design atractiv – disponibile în modele variate pentru copii și adulți.

EN

LED night lights offer soft and comforting illumination throughout the night, making them ideal for bedrooms and children's rooms.

FEATURES

- Gentle light – perfect for a restful sleep;
- Minimal energy consumption – efficient LED technology for long-term use;
- Attractive design – available in various models for both children and adults.

LED 230V IP20



| RO | Cod | Denumire | Putere consumată | Temperatură de culoare | Material | Culoare | Dimensiune |
|----|------|----------|------------------|------------------------|----------|---------|------------|
| EN | Code | Name | Power | Color temperature | Material | Color | Size |

ERSTE

| | | | | | | | |
|-----------|-------------------------------------|--|------|---|---------|-----------------|----------|
| EL0024015 | | | | - | | Albastru / Blue | |
| EL0024016 | Lampă veghe AVIA / Night light AVIA | | 0.4W | - | Plastic | Verde / Green | 32x130mm |
| EL0024017 | | | | - | | Alb / White | |



LED 230V IP20

ERSTE

| | | | | | | | |
|-----------|---------------------------------------|--|------|---|---------|-------------|----------|
| EL0024022 | Lampă veghe BALSĂ / Night light BALSĂ | | 0.4W | - | Plastic | Alb / White | 32x130mm |
|-----------|---------------------------------------|--|------|---|---------|-------------|----------|



LED 230V IP20 CCT

ERSTE

| | | | | | | | |
|-----------|-------------------------------------|--|------|------------|---------|-----------------|---------|
| EL0081486 | Lampă veghe BLUE / Night light BLUE | | 1.2W | 3000-6000K | Plastic | Albastru / Blue | 80x95mm |
|-----------|-------------------------------------|--|------|------------|---------|-----------------|---------|



LED 230V IP20

ERSTE

| | | | | | | | |
|-----------|---------------------------------------|--|------|---|---------|-----------------|---------|
| EL0024003 | | | | - | | Rosu / Red | |
| EL0024005 | | | | - | | Albastru / Blue | |
| EL0024006 | Lampă veghe BLUME / Night light BLUME | | 0.4W | - | Plastic | Verde / Green | 60x60mm |
| EL0024007 | | | | - | | Alb / White | |

LED 230V IP20



| RO | Cod | Denumire | Putere consumată | Temperatură de culoare | Material | Culoare | Dimensiune |
|----|------|----------|------------------|------------------------|----------|---------|------------|
| EN | Code | Name | Power | Color temperature | Material | Color | Size |

ERSTE

| | | | | | | |
|-----------|-------------------------------------|----|------------|---------|-------------|---------|
| EL0081484 | Lampă veghe BULB / Night light BULB | 1W | 3000-6000K | Plastic | Alb / White | 50X90mm |
|-----------|-------------------------------------|----|------------|---------|-------------|---------|

IP20 230V IP20

**ERSTE**

| | | | | | | |
|-----------|---|------|---|---------|-----------------|---------|
| EL0024029 | | | - | | Galben / Yellow | |
| EL0024030 | Lampă veghe CLIMBO / Night light CLIMBO | 0.4W | - | Plastic | Albastru / Blue | 60x85mm |
| EL0024032 | | | - | | Mov / Purple | |

LED 230V IP20 CCT

**ERSTE**

| | | | | | | |
|-----------|---|----|------------|---------|-------------|---------|
| EL0081485 | Lampă veghe FLINKY / Night light FLINKY | 1W | 3000-6000K | Plastic | Alb / White | 43X97mm |
|-----------|---|----|------------|---------|-------------|---------|

LED 230V IP20



| RO | Cod | Denumire | Putere consumată | Temperatură de culoare | Material | Culoare | Dimensiune |
|----|------|----------|------------------|------------------------|----------|---------|------------|
| EN | Code | Name | Power | Color temperature | Material | Color | Size |

ERSTE

| | | | | | | |
|-----------|---------------------------------------|----|-------|---------|-------------|---------|
| EL0081481 | Lampă veghe LADYS / Night light LADYS | 1W | 6000K | Plastic | Alb / White | 73X90mm |
|-----------|---------------------------------------|----|-------|---------|-------------|---------|

LED 230V IP20

**ERSTE**

| | | | | | | |
|-----------|-------------------------------------|------|---|---------|------------|---------|
| EL0024038 | Lampă veghe MAIA / Night light MAIA | 0.4W | - | Plastic | Multicolor | 60x85mm |
|-----------|-------------------------------------|------|---|---------|------------|---------|

LED 230V IP20

**ERSTE**

| | | | | | | |
|-----------|-------------------------------------|------|---|---------|-----------------|---------|
| EL0024008 | | | - | | Rosu / Red | |
| EL0024009 | | | - | | Galben / Yellow | |
| EL0024010 | Lampă veghe MARA / Night light MARA | 0.3W | - | Plastic | Albastru / Blue | 55x55mm |
| EL0024011 | | | - | | Verde / Green | |
| EL0024012 | | | - | | Alb / White | |

LED 230V IP20



| RO | Cod | Denumire | Putere consumată | Temp. de culoare | Material | Culoare | Dimensiune |
|----|------|----------|------------------|------------------|----------|---------|------------|
| EN | Code | Name | Power | Color temp. | Material | Color | Size |

ERSTE

| | | | | | | |
|-----------|---|------|---|---------|-----------------|---------|
| EL0023998 | Lampă veghe PAPILLON / Night light PAPILLON | 0.3W | - | Plastic | Roșu / Red | 50x75mm |
| EL0024000 | | | | | Albastru / Blue | |
| EL0024001 | | | | | Verde / Green | |
| EL0024002 | | | | | Alb / White | |

LED 230V IP20

**ERSTE**

| | | | | | | |
|-----------|---------------------------------|----|-------|---------|------------|---------|
| EL0081482 | Lampă PINKY / Night light PINKY | 1W | 6000K | Plastic | Roz / Pink | 82x85mm |
|-----------|---------------------------------|----|-------|---------|------------|---------|

LED 230V IP20

**ERSTE**

| | | | | | | |
|-----------|-------------------------------------|------|---|---------|-----------------|---------|
| EL0023994 | Lampă veghe ROSA / Night light ROSA | 0.4W | - | Plastic | Galben / Yellow | 50x50mm |
| EL0023997 | | | | | Alb / White | |



LED 230V IP20



| RO | Cod | Denumire | Putere consumată | Temperatură de culoare | Flux luminos | Material | Culoare | Dimensiune |
|----|------|----------|------------------|------------------------|---------------|----------|---------|------------|
| EN | Code | Name | Power | Color temperature | Luminous flux | Material | Color | Size |

HOMELIGHT

| | | | | | | | |
|-----------|------------------------------|------|-------|------|-----|-------------|---------|
| EL0081071 | Lampă de veghe / Night light | 0.8W | 6000K | 50lm | ABS | Alb / White | 92x53mm |
|-----------|------------------------------|------|-------|------|-----|-------------|---------|



SPOTURI INTERIOR LED INDOOR LED SPOTLIGHT

RO

Spoturile LED sunt ideale pentru iluminatul direcționat, oferind o luminozitate precisă și eficiență energetică, potrivită pentru evidențierea detaliilor arhitecturale sau decorative.

REPERE

- **Precizie și claritate** – ideale pentru accentuarea zonelor specifice;
- **Flexibilitate** – disponibile în variante fixe sau reglabile;
- **Eficiență energetică** – consum redus și durată de viață extinsă.

EN

LED spotlights are ideal for directional lighting, offering precise and energy-efficient brightness, perfect for highlighting architectural or decorative details.

FEATURES

- **Precision and clarity** – ideal for accentuating specific areas;
- **Flexibility** – available in fixed or adjustable versions;
- **Energy efficiency** – low consumption and extended lifespan.

LED 230V IP20



Spot rotund / Circular spot
90x45mm



Spot patrat / Square spot
75x75x45mm

| RO | Cod | Denumire | Putere consumată | Temperatură de culoare | Flux luminos | Material | Culoare | Dimensiune |
|----|------|----------|------------------|------------------------|---------------|----------|---------|------------|
| EN | Code | Name | Power | Color temperature | Luminous flux | Material | Color | Size |

ERSTE

| | | | | | | | | |
|-----------|-------------------------------------|------------|-------|-------|---------------------------------|-------------|---------|------------|
| EL0048147 | Spot OPTIMUS / Spotlight OPTIMUS | 3W | 2700K | 240lm | Termoplastic / Thermoplastic | Alb / White | 90x45mm | |
| EL0048148 | | | 4000K | | | | | |
| EL0048149 | | | 6500K | | | | | |
| EL0048150 | | | 2700K | | | | | |
| EL0048151 | | | 4000K | | | | | |
| EL0048152 | | 5W | 6500K | 400lm | | | | 75x75x45mm |
| EL0048153 | | | 2700K | | | | | |
| EL0048154 | | | 4000K | | | | | |
| EL0048155 | | | 6500K | | | | | |
| EL0048156 | | | 2700K | | | | | |
| EL0048157 | 4000K | 75x75x45mm | | | | | | |
| EL0048158 | 6500K | | | | | | | |

LED 230V IP20



RO

| Cod | Denumire | Putere consumată | Temperatură de culoare | Flux luminos | Material | Culoare | Dimensiune |
|-----|----------|------------------|------------------------|--------------|----------|---------|------------|
|-----|----------|------------------|------------------------|--------------|----------|---------|------------|

EN

| Code | Name | Power | Color temperature | Luminous flux | Material | Color | Size |
|------|------|-------|-------------------|---------------|----------|-------|------|
|------|------|-------|-------------------|---------------|----------|-------|------|

ERSTE

| | | | | | | | |
|-----------|-------------------------------|-----|-------|--------|-----------------|---------------|-----------|
| EL0081444 | Spot BART / Spotlight BART | 18W | 6500K | 2160lm | Metal + Plastic | Negru / Black | 150x100mm |
| EL0081445 | | | | | | Alb / White | |

LED 230V IP20

**ERSTE**

| | | | | | | | |
|-----------|-------------------------------|-----|-------|--------|-----------------|---------------|--------------|
| EL0081442 | Spot KABO / Spotlight KABO | 10W | 6500K | 1150lm | Metal + Plastic | Negru / Black | 150x110x55mm |
| EL0081443 | | 15W | | 1725lm | | | 390x150x55mm |

LED 230V IP20



RO

| Cod | Denumire | Putere consumată | Temperatură de culoare | Flux luminos | Material | Culoare | Dimensiune |
|-----|----------|------------------|------------------------|--------------|----------|---------|------------|
|-----|----------|------------------|------------------------|--------------|----------|---------|------------|

EN

| Code | Name | Power | Color temperature | Luminous flux | Material | Color | Size |
|------|------|-------|-------------------|---------------|----------|-------|------|
|------|------|-------|-------------------|---------------|----------|-------|------|

ERSTE

| | | | | | | | |
|-----------|-----------------------------|----|-------|------|----|-------------|------------|
| EL0081491 | Spot Treaptă / Spotlight | 1W | 4000K | 50lm | PC | Alb / White | 86x86x35mm |
|-----------|-----------------------------|----|-------|------|----|-------------|------------|

LED 230V IP20



RO

| Cod | Denumire | Putere consumată | Temperatură de culoare | Flux luminos | Material | Culoare | Dimensiune |
|-----|----------|------------------|------------------------|--------------|----------|---------|------------|
|-----|----------|------------------|------------------------|--------------|----------|---------|------------|

EN

| Code | Name | Power | Color temperature | Luminous flux | Material | Color | Size |
|------|------|-------|-------------------|---------------|----------|-------|------|
|------|------|-------|-------------------|---------------|----------|-------|------|

ERSTE

| | | | | | | | |
|-----------|--|----|-------|------|----|-------------|------------|
| EL0081492 | Spot LED cu senzor pentru treaptă / LED sensor light for stairs | 1W | 4000K | 50lm | PC | Alb / White | 86x86x35mm |
|-----------|--|----|-------|------|----|-------------|------------|

LED 230V IP20



| RO | Cod | Denumire | Putere consumată | Temperatură de culoare | Flux luminos | Material | Culoare | Dimensiune |
|----|------|----------|------------------|------------------------|---------------|----------|---------|------------|
| EN | Code | Name | Power | Color temperature | Luminous flux | Material | Color | Size |

NOVELITE

| | | | | | | | |
|-----------|--|-----------------|-------------|-------|-------|--------|-------|
| EL0036443 | KIT LED Plafonieră / Ceiling lamp KIT | Metal + Plastic | Alb / White | 18W | 6500K | 1260lm | 225mm |
| EL0036444 | | | | 2700K | | | |
| EL0036445 | | | | 24W | 6500K | 1680lm | 277mm |
| EL0036446 | | | | 6500K | | | |

ACCESORII INTERIOR LED

INDOOR LED ACCESSORIES

RO

Accesoriile LED sunt componente esențiale pentru sistemele moderne de iluminat, asigurând eficiență și durabilitate în optimizarea performanței surselor de lumină.

REPERE

- **Compatibilitate extinsă** – funcționează cu o gamă variată de corpuri de iluminat LED;
- **Eficiență energetică ridicată** – maximizează performanța și durata de viață a iluminatului LED;
- **Instalare ușoară** – integrate rapid și simplu în orice sistem de iluminat.

EN

LED accessories are essential components for modern lighting systems, ensuring efficiency and durability while optimizing light source performance.

FEATURES

- **Extended compatibility** – works with a wide range of LED lighting fixtures;
- **High energy efficiency** – maximizes LED lighting performance and lifespan;
- **Easy installation** – quick and simple integration into any lighting system.

LED 230V IP54



| RO | Cod | Denumire | Putere consumată | Temperatură de culoare | Flux luminos | Material | Culoare | Dimensiune |
|----|------|----------|------------------|------------------------|---------------|----------|---------|------------|
| EN | Code | Name | Power | Color temperature | Luminous flux | Material | Color | Size |

ERSTE

| | | | | | | | |
|-----------|--|-----|-------|--------|----|---------------|----------|
| EL0081432 | Plafonieră DARS / Ceiling lamp DARS | 18W | 4000K | 1620lm | PP | Negru / Black | 250x50mm |
| EL0081433 | | 28W | | 2520lm | | | 320x55mm |

LED 230V IP54



| RO | Cod | Denumire | Putere consumată | Temperatură de culoare | Flux luminos | Senzor prezență | Material | Culoare | Dimensiune |
|----|------|----------|------------------|------------------------|---------------|-------------------------|----------|---------|------------|
| EN | Code | Name | Power | Color temperature | Luminous flux | Motion detection sensor | Material | Color | Size |

ERSTE

| | | | | | | | | |
|-----------|--|-----|-----------------|--------|----------|----------|--------------------------------------|------------|
| EL0078031 | Plafonieră RUUT / Ceiling lamp RUUT | 24W | 4000K | 2280lm | Da / Yes | PC + ABS | Alb + Negru / White + Black | 300x57.5mm |
| EL0086065 | | 24W | 3000-4000-6500K | 2760lm | Nu / No | | | |



PLAFONIERE EXTERIOR LED

OUTDOOR LED CEILING LAMPS

RO

Plafonierele LED sunt soluții practice și eficiente pentru iluminarea generală a spațiilor exterioare, cum ar fi terasele, balcoanele sau intrările. Acestea oferă o distribuție uniformă a luminii și un consum minim de energie.

REPERE

- Distribuție uniformă - iluminare LED amplă și echilibrată;
- Economie de spațiu - montaj direct pe tavan pentru un aspect discret;
- Rezistență sporită - materiale durabile, potrivite pentru utilizare în exterior.

EN

LED ceiling lamps are practical and efficient solutions for general outdoor lighting, perfect for terraces, balconies, or entrances. They provide uniform light distribution and minimal energy consumption.

FEATURES

- Uniform distribution - ample and balanced LED lighting;
- Space saving - direct ceiling mounting for a discreet look;
- High durability - durable materials, suitable for outdoor use.

LED 230V IP44



| RO | Cod | Denumire | Putere consumată | Temperatură de culoare | Flux luminos | Material | Culoare | Dimensiune |
|----|------|----------|------------------|------------------------|---------------|----------|---------|------------|
| EN | Code | Name | Power | Color temperature | Luminous flux | Material | Color | Size |

NOVELITE

| | | | | | | | |
|-----------|-----------------------------------|-----|-------|--------|-----|-------------|----------|
| EL0078020 | Plafonieră LED / LED Ceiling lamp | 18W | 6400K | 1440lm | PVC | Alb / White | 300x58mm |
|-----------|-----------------------------------|-----|-------|--------|-----|-------------|----------|

LED 230V IP44



HOMELIGHT

| | | | | | | | |
|-----------|-----------------------------------|-----|-------|--------|-----------------|-------------|----------|
| EL0081067 | Plafonieră LED / LED Ceiling lamp | 25W | 6500K | 2450lm | Metal + Plastic | Alb / White | 300x50mm |
|-----------|-----------------------------------|-----|-------|--------|-----------------|-------------|----------|

LED 230V IP44



HOMELIGHT

| | | | | | | | |
|-----------|-----------------------------------|-----|-------|--------|-----------------|-------------|----------|
| EL0081068 | Plafonieră LED / LED Ceiling lamp | 16W | 6500K | 1600lm | Metal + Plastic | Alb / White | 260x50mm |
|-----------|-----------------------------------|-----|-------|--------|-----------------|-------------|----------|





APLICE EXTERIOR LED OUTDOOR LED WALL LAMPS

RO

Aplicele LED sunt soluții elegante și funcționale pentru iluminatul ambiental sau decorativ al fațadelor, teraselor și grădinilor. Acestea oferă un consum redus de energie și o lumină de calitate superioară, îmbunătățind estetica și siguranța spațiilor exterioare.

REPERE

- **Iluminare direcționată** – lumină focalizată sau difuză, în funcție de model;
- **Design variat** – disponibile în multiple stiluri pentru integrare armonioasă;
- **Tehnologie LED** – consum redus și durată de viață extinsă.

EN

LED wall lights are elegant and functional solutions for ambient or decorative lighting on facades, terraces, and gardens. They provide low energy consumption and high-quality illumination, enhancing both the aesthetics and safety of outdoor spaces.

FEATURES

- **Directed lighting** – focused or diffused light, depending on the model;
- **Varied designs** – available in multiple styles for seamless integration;
- **LED technology** – low consumption and extended lifespan.

LED 230V IP54



| RO | Cod | Denumire | Putere consumată | Temperatură de culoare | Flux luminos | Material | Culoare | Dimensiune |
|----|------|----------|------------------|------------------------|---------------|----------|---------|------------|
| EN | Code | Name | Power | Color temperature | Luminous flux | Material | Color | Size |

ERSTE

| | | | | | | | |
|-----------|----------------------------------|-----|-------|--------|----------------------|---------------|--------------|
| EL0081421 | Aplică BASTET / Wall lamp BASTET | 12W | 6500K | 1140lm | Aluminiu / Aluminium | Negru / Black | 165x150x85mm |
|-----------|----------------------------------|-----|-------|--------|----------------------|---------------|--------------|

LED 230V IP54



ERSTE

| | | | | | | | |
|-----------|--|-----|-------|-------|--------------------------------|---------------|-----------|
| EL0078034 | Aplică BRIGHTLIT / Wall lamp BRIGHTLIT | 11W | 4000K | 825lm | Aluminiu + PC / Aluminium + PC | Negru / Black | 140x180mm |
|-----------|--|-----|-------|-------|--------------------------------|---------------|-----------|

LED 230V IP54



| RO | Cod | Denumire | Putere consumată | Temperatură de culoare | Flux luminos | Material | Culoare | Seznor prezență | Dimensiune |
|----|------|----------|------------------|------------------------|---------------|----------|---------|-------------------------|------------|
| EN | Code | Name | Power | Color temperature | Luminous flux | Material | Color | Motion detection sensor | Size |

ERSTE

| | | | | | | | | |
|-----------|------------------------------------|-----|-------|--------|--------------------------------|---------------|----------|--------------|
| EL0078013 | Aplică DETROIT / Wall lamp DETROIT | 24W | 4000K | 1200lm | Aluminiu + PC / Aluminium + PC | Negru / Black | Da / Yes | 293x91x100mm |
| EL0078014 | | | | | | | Nu / No | |

LED 230V IP65



| RO | Cod | Denumire | Putere consumată | Temperatură de culoare | Flux luminos | Material | Culoare | Dimensiune |
|----|------|----------|------------------|------------------------|---------------|----------|---------|------------|
| EN | Code | Name | Power | Color temperature | Luminous flux | Material | Color | Size |

ERSTE

| | | | | | | | |
|-----------|------------------------------|-----|-------|--------|-----|---------------|---------------|
| EL0081426 | Aplică EDON / Wall lamp EDON | 18W | 4000K | 1080lm | ABS | Negru / Black | 232x140x120mm |
|-----------|------------------------------|-----|-------|--------|-----|---------------|---------------|



LED 230V IP65

ERSTE

| | | | | | | | |
|-----------|------------------------------|-----|-------|--------|-----|---------------|--------------|
| EL0081427 | Aplică ELAN / Wall lamp ELAN | 18W | 4000K | 1080lm | ABS | Negru / Black | 232x140x97mm |
|-----------|------------------------------|-----|-------|--------|-----|---------------|--------------|



LED 230V IP65

ERSTE

| | | | | | | | |
|-----------|----------------------------------|-----|-------|--------|----------------------|---------------|---------------|
| EL0081422 | Aplică HATHOR / Wall lamp HATHOR | 16W | 4000K | 1280lm | Aluminiu / Aluminium | Negru / Black | 210x180x150mm |
|-----------|----------------------------------|-----|-------|--------|----------------------|---------------|---------------|



LED 230V IP65

ERSTE

| | | | | | | | |
|-----------|----------------------------------|-----|-------|-------|-------|---------------|-------------|
| EL0081431 | Aplică LINEAR / Wall lamp LINEAR | 18W | 4000K | 900lm | Metal | Negru / Black | 800x80x45mm |
|-----------|----------------------------------|-----|-------|-------|-------|---------------|-------------|

LED 230V IP44



| RO | Cod | Denumire | Putere consumată | Temperatură de culoare | Flux luminos | Material | Culoare | Dimensiune |
|----|------|----------|------------------|------------------------|---------------|----------|---------|------------|
| EN | Code | Name | Power | Color temperature | Luminous flux | Material | Color | Size |

ERSTE

| | | | | | | | |
|-----------|--------------------------------------|----|-------|-------|---------|---------------|-----------|
| EL0058667 | Aplică MEPHISTO / Wall lamp MEPHISTO | 8W | 4000K | 640lm | Plastic | Negru / Black | 185x225mm |
| EL0058668 | | | | | | | |



LED 230V IP65

ERSTE

| | | | | | | | |
|-----------|----------------------------------|-----|-------|--------|--------------------------------|---------------|-------------|
| EL0081424 | Aplică MILANO / Wall lamp MILANO | 13W | 4000K | 1105lm | Aluminiu + PC / Aluminium + PC | Negru / Black | 135x90x85mm |
|-----------|----------------------------------|-----|-------|--------|--------------------------------|---------------|-------------|

LED 230V IP54



ERSTE

| | | | | | | | |
|-----------|--------------------------------|----|-------|-------|----------------------|---------------|-------------|
| EL0081416 | | 3W | | 255lm | | | 80x75x35mm |
| EL0081417 | Aplică MONTY / Wall lamp MONTY | 4W | 3000K | 340lm | Aluminiu / Aluminium | Negru / Black | 120x80x30mm |
| EL0081418 | | 6W | | 510lm | | | 165x80x40mm |

LED 230V IP65



| RO | Cod | Denumire | Putere consumată | Temperatură de culoare | Flux luminos | Material | Culoare | Dimensiune |
|----|------|----------|------------------|------------------------|---------------|----------|---------|------------|
| EN | Code | Name | Power | Color temperature | Luminous flux | Material | Color | Size |

ERSTE

| | | | | | | | |
|-----------|---------------------------------|-----|-------|--------|-----------------------------------|---------------|---------------|
| EL0081425 | Aplică NISA / Wall lamp NISA | 13W | 6000K | 1105lm | Aluminiu + PC / Aluminium + PC | Negru / Black | 105x100x135mm |
|-----------|---------------------------------|-----|-------|--------|-----------------------------------|---------------|---------------|



LED 230V IP54

ERSTE

| | | | | | | | |
|-----------|-----------------------------------|-----|-------|-------|-------------------------|---------------|--------------|
| EL0081420 | Aplică ONDER / Wall lamp ONDER | 12W | 6500K | 960lm | Aluminiu / Aluminium | Negru / Black | 200x100x70mm |
|-----------|-----------------------------------|-----|-------|-------|-------------------------|---------------|--------------|



LED 230V IP44

ERSTE

| | | | | | | | |
|-----------|---------------------------------------|-------|-------|-------|--------------------------------------|---------------|-----------|
| EL0026573 | Aplică PIRAMID / Wall lamp PIRAMID | 2.88W | 6400K | 144lm | Oțel inoxidabil / Stainless steel | Crom / Chrome | 125x165mm |
|-----------|---------------------------------------|-------|-------|-------|--------------------------------------|---------------|-----------|



LED 230V IP65

ERSTE

| | | | | | | | |
|-----------|-----------------------------------|----|-------|-------|-------------------------|---------------|---------------|
| EL0081428 | Aplică RANDY / Wall lamp RANDY | 6W | 4000K | 480lm | Aluminiu / Aluminium | Negru / Black | 100x100x100mm |
|-----------|-----------------------------------|----|-------|-------|-------------------------|---------------|---------------|

LED 230V IP54



| RO | Cod | Denumire | Putere consumată | Temperatură de culoare | Flux luminos | Material | Culoare | Dimensiune |
|----|------|----------|------------------|------------------------|---------------|----------|---------|------------|
| EN | Code | Name | Power | Color temperature | Luminous flux | Material | Color | Size |

ERSTE

| | | | | | | | |
|-----------|-------------------------------|----|-------|-------|-------------------------|---------------|--------------|
| EL0081419 | Aplică RAY / Wall lamp RAY | 5W | 6000K | 400lm | Aluminiu / Aluminium | Negru / Black | 160x65x160mm |
|-----------|-------------------------------|----|-------|-------|-------------------------|---------------|--------------|

LED 230V IP65

**ERSTE**

| | | | | | | | |
|-----------|-----------------------------------|-----|-------|-------|----------|---------------|--------------|
| EL0078018 | Aplică SIERA / Wall lamp SIERA | 12W | 6000K | 840lm | ABS + PS | Negru / Black | 170x170x90mm |
| EL0078019 | | | | | | | |

LED 230V IP54

**ERSTE**

| | | | | | | | |
|-----------|-----------------------------------|-----|-------|--------|-------------------------|---------------|---------------|
| EL0081423 | Aplică TANOR / Wall lamp TANOR | 18W | 6500K | 1350lm | Aluminiu / Aluminium | Negru / Black | 260x120x125mm |
|-----------|-----------------------------------|-----|-------|--------|-------------------------|---------------|---------------|



| RO | Cod | Denumire | Putere consumată | Temperatură de culoare | Flux luminos | Material | Culoare | Dimensiune |
|----|------|----------|------------------|------------------------|---------------|----------|---------|------------|
| EN | Code | Name | Power | Color temperature | Luminous flux | Material | Color | Size |

ERSTE

| | | | | | | | |
|-------------|------------------------------|-----|-------|--------|--------------------------------|---------------|--------------|
| EL0078015 | Aplică WALD / Wall lamp WALD | 15W | 4000K | 1125lm | Aluminiu + PS / Aluminium + PS | Negru / Black | 160x80x275mm |
| EL0078016 * | | | | | | | |

* Nu are senzor / No sensor included.



HOMELIGHT

| | | | | | | | |
|-----------|---|-----|-------|--------|-----------------|---|-----------|
| EL0081069 | Aplică exterior LED / LED Outdoor wall lamp | 20W | 4200K | 2100lm | Metal + Plastic | - | 230x138mm |
|-----------|---|-----|-------|--------|-----------------|---|-----------|



ERSTE

| | | | | | | | |
|-----------|----------------------------------|------|-------|---------|---------------------------------------|---------------|-------------|
| EL0042532 | Aplică DENZEL / Wall lamp DENZEL | 2x3W | 4000K | 2x195lm | Aluminiu + Sticlă / Aluminium + Glass | Negru / Black | 170x84x47mm |
|-----------|----------------------------------|------|-------|---------|---------------------------------------|---------------|-------------|



| RO | Cod | Denumire | Putere consumată | Temperatură de culoare | Flux luminos | Material | Culoare | Dimensiune |
|----|------|----------|------------------|------------------------|---------------|----------|---------|------------|
| EN | Code | Name | Power | Color temperature | Luminous flux | Material | Color | Size |

HOMELIGHT

| | | | | | | | |
|-----------|--------------------------------|-----|-------|--------|-------|---------------|----------|
| EL0085850 | Aplică HL-A8 / Wall lamp HL-A8 | 25W | 8000K | 2125lm | PP+PS | Negru / Black | 200x55mm |
|-----------|--------------------------------|-----|-------|--------|-------|---------------|----------|



HOMELIGHT

| | | | | | | | |
|-----------|--------------------------------|-----|-------|--------|--------|---------------|-----------|
| EL0085847 | Aplică HL-A3 / Wall lamp HL-A3 | 10W | 6500K | 1150lm | ABS+PS | Negru / Black | 130x120mm |
|-----------|--------------------------------|-----|-------|--------|--------|---------------|-----------|



ERSTE

| | | | | | | | |
|-----------|--------------------------------|----|-------|-------|--------|---------------|--------------|
| EL0085849 | Aplică HL-A4 / Wall lamp HL-A4 | 6W | 8000K | 600lm | ABS+PS | Negru / Black | 105x96x115mm |
|-----------|--------------------------------|----|-------|-------|--------|---------------|--------------|



SPOTURI EXTERIOR LED OUTDOOR LED SPOTLIGHTS

RO

Spoturile LED sunt ideale pentru iluminatul direcționat, oferind o luminozitate precisă și eficiență pentru evidențierea elementelor arhitecturale, aleilor, treptelor sau zonelor de interes din grădină.

REPERE

- **Iluminare precisă** – potrivite pentru accentuarea zonelor specifice sau obiectelor decorative;
- **Flexibilitate** – disponibile în variante fixe sau reglabile pentru ajustarea fasciculului luminos;
- **Eficiență energetică** – consum redus și durată de viață extinsă datorită tehnologiei LED.

EN

LED spotlights are ideal for directional lighting, providing precise and energy-efficient brightness to highlight architectural elements, pathways, the steps of the stair or specific areas in the garden.

FEATURES

- **Precision lighting** – fitted for accentuating specific areas or decorative objects;
- **Flexibility** – available in fixed or adjustable models to control the light beam;
- **Energy efficiency** – low power consumption and extended lifespan thanks to LED technology.

LED 230V IP65



| RO | Cod | Denumire | Putere consumată | Temperatură de culoare | Flux luminos | Material | Culoare | Dimensiune |
|----|------|----------|------------------|------------------------|---------------|----------|---------|------------|
| EN | Code | Name | Power | Color temperature | Luminous flux | Material | Color | Size |

ERSTE

| | | | | | | | |
|-----------|--------------------------------------|------|-------|------|---------------------|------------|-------------|
| EL0026256 | Spot LED ARMIN / LED Spotlight ARMIN | 1.2W | 6400K | 54lm | Aluminiu / Aluminum | Gri / Gray | 111x46x53mm |
| EL0026257 | | | 2700K | | | | |

LED 230V IP65



ERSTE

| | | | | | | | |
|-----------|--------------------------------------|------|-------|------|---------------------|------------|-----------|
| EL0026254 | Spot LED DIXON / LED Spotlight DIXON | 1.8W | 6400K | 80lm | Aluminiu / Aluminum | Gri / Gray | 141x139mm |
|-----------|--------------------------------------|------|-------|------|---------------------|------------|-----------|

LED 12V IP68



ERSTE

| | | | | | | | |
|-----------|---|-------|-------|-------|-----------------------------------|---------------|-------------|
| EL0028639 | Spot LED Piscină MIRKO / LED Pool spotlight MIRKO | 3.24W | 2700K | 194lm | Oțel inoxidabil / Stainless steel | Crom / Chrome | 119x85mm |
| EL0057324 | | 3x1W | RGB | - | | | 140x80mm |
| EL0059447 | | 3x1W | 6400K | 194lm | | | 80x140mm |
| EL0057325 | Driver pentru spot piscină / Driver for pool lighting | 60W | - | - | | Negru / Black | 110x75x80mm |

LED 230V IP54



| RO | Cod | Denumire | Putere consumată | Temperatură de culoare | Flux luminos | Material | Culoare | Dimensiune |
|----|------|----------|------------------|------------------------|---------------|----------|---------|------------|
| EN | Code | Name | Power | Color temperature | Luminous flux | Material | Color | Size |

ERSTE

| | | | | | | | |
|-----------|--|----|-------|-------|---------------------|---------------|-------------|
| EL0081429 | Spot treaptă încastat LED / LED step spotlight | 3W | 3000K | 120lm | Aluminiu / Aluminum | Negru / Black | 140x70x55mm |
|-----------|--|----|-------|-------|---------------------|---------------|-------------|

LED 230V IP54



ERSTE

| | | | | | | | |
|-----------|--|----|-------|-------|---------------------|---------------|------------|
| EL0081430 | Spot treaptă încastat LED / LED step spotlight | 3W | 3000K | 120lm | Aluminiu / Aluminum | Negru / Black | 85x85x55mm |
|-----------|--|----|-------|-------|---------------------|---------------|------------|

LED 230V IP65



ERSTE

| | | | | | | | |
|-----------|--------------------------------------|------|-------|------|---------------------|------------|-----------|
| EL0026250 | Spot LED VENUS / LED spotlight VENUS | 1,4W | 6400K | 54lm | Aluminiu / Aluminum | Gri / Gray | 126x126mm |
|-----------|--------------------------------------|------|-------|------|---------------------|------------|-----------|





LĂMPI SOLARE EXTERIOR LED

OUTDOOR LED SOLAR LIGHTS

RO

Lămpile solare LED sunt o soluție ecologică și economică pentru iluminatul exterior, utilizând energie regenerabilă pentru a oferi lumină fiabilă pe timp de noapte.

REPERE

- **Energie verde** – alimentate de panouri solare;
- **Autonomie mare** – stocarea energiei pentru iluminare nocturnă eficientă;
- **Instalare simplă** – fără cabluri sau prize, montaj rapid și flexibil.

EN

LED solar lamps are an eco-friendly and cost-effective solution for outdoor lighting, using renewable energy to provide reliable illumination throughout the night.

FEATURES

- **Green energy** – powered by solar panels;
- **Long autonomy** – energy storage for efficient nighttime lighting;
- **Easy installation** – no need for cables or outlets, ensuring quick and flexible setup.



| RO | Cod | Denumire | Temperatură de culoare | Flux luminos | Material | Culoare | Dimensiune |
|----|------|----------|------------------------|---------------|----------|---------|------------|
| EN | Code | Name | Color temperature | Luminous flux | Material | Color | Size |

ERSTE

| | | | | | | | |
|-----------|--|--|-------|-----|----|---------------|----------|
| EL0078026 | Lampă solară ATRISTAR / Solar light ATRISTAR | | 4000K | 1lm | PP | Negru / Black | 85x395mm |
|-----------|--|--|-------|-----|----|---------------|----------|



ERSTE

| | | | | | | | |
|-----------|--|--|-------|------|---------|---------------|--------------|
| EL0081434 | Lampă solară BAYERN / Solar light BAYERN | | 3000K | 50lm | PP + PS | Negru / Black | 170x120x65mm |
|-----------|--|--|-------|------|---------|---------------|--------------|



ERSTE

| | | | | | | | |
|-----------|--|--|-------|-----|----|---------------|--------------|
| EL0078022 | Lampă solară FERRY / Solar light FERRY | | 6400K | 2lm | PP | Negru / Black | 140x90x298mm |
|-----------|--|--|-------|-----|----|---------------|--------------|



ERSTE

| | | | | | | | |
|-----------|------------------------------------|--|-------|-----|----|---------------|----------|
| EL0078027 | Lampă solară SKY / Solar light SKY | | 4000K | 1lm | PP | Negru / Black | 70x370mm |
|-----------|------------------------------------|--|-------|-----|----|---------------|----------|

LED IP44



| RO | Cod | Denumire | Temperatură de culoare | Flux luminos | Material | Culoare | Dimensiune |
|----|------|----------|------------------------|---------------|----------|---------|------------|
| EN | Code | Name | Color temperature | Luminous flux | Material | Color | Size |

ERSTE

| | | | | | | |
|-----------|--------------------------------------|-------|-----|----|---------------|-----------|
| EL0078023 | Lampă solară SOLE / Solar light SOLE | 4000K | 1lm | PP | Negru / Black | 100x330mm |
| EL0083462 | | RGB | - | | | |



LED IP44

ERSTE

| | | | | | | |
|-----------|--|-------|-----|----|---------------|----------|
| EL0078021 | Lampă solară SPARK / Solar light SPARK | 3000K | 1lm | PP | Negru / Black | 73x515mm |
|-----------|--|-------|-----|----|---------------|----------|



LED IP44

ERSTE

| | | | | | | |
|-----------|--|-------|-----|----|---------------|----------|
| EL0078025 | Lampă solară VEGASTAR / Solar light VEGASTAR | 4000K | 5lm | PP | Negru / Black | 85x370mm |
|-----------|--|-------|-----|----|---------------|----------|



LED IP44

ERSTE

| | | | | | | |
|-----------|--|-------|-----|---|-------------------|----------|
| EL0078024 | Lampă solară VERITY / Solar light VERITY | 4000K | 5lm | Oțel inoxidabil + plastic / Stainless steel + plastic | Argintiu / Silver | 63x385mm |
|-----------|--|-------|-----|---|-------------------|----------|



LED IP44

| RO | Cod | Denumire | Putere | Temperatură de culoare | Material | Culoare | Dimensiune |
|----|------|----------|--------|------------------------|----------|---------|------------|
| EN | Code | Name | Power | Color temperature | Material | Color | Size |

HOMELIGHT

| | | | | | | |
|-----------|---|-------|---|---------|---------------|----------|
| EL0081074 | Aplică solară LED / LED solar wall lamp | 0.35W | - | Plastic | Negru / Black | 123x95mm |
|-----------|---|-------|---|---------|---------------|----------|



LED 230V IP44

HOMELIGHT

| | | | | | | |
|-----------|---|-------|---|---------|---------------|----------|
| EL0081076 | Aplică solară LED / LED solar wall lamp | 0.35W | - | Plastic | Negru / Black | 135x97mm |
|-----------|---|-------|---|---------|---------------|----------|



LANTERNE LED

LED FLASHLIGHT

RO

Lanternele LED sunt soluția ideală pentru iluminatul portabil în aer liber, oferind o sursă de lumină puternică și eficientă pentru camping, drumeții sau situații de urgență.

REPERE

- **Portabilitate** – ușor de transportat și utilizat oriunde;
- **Autonomie ridicată** – modele cu baterii eficiente sau reîncărcabile;
- **Durabilitate** – rezistente la intemperii și utilizare în condiții variate.

EN

LED flashlight are the perfect solution for portable outdoor lighting, offering a powerful and efficient light source for camping, hiking or emergencies.

FEATURES

- **Portability** – easy to carry and use anywhere;
- **Long battery life** – available in battery-powered or rechargeable models;
- **Durability** – resistant to harsh weather conditions and heavy use.

LED IP20



| RO | Cod | Denumire | Putere consumată | Material | Culoare | Dimensiune |
|----|------|----------|------------------|----------|---------|------------|
| EN | Code | Name | Power | Material | Color | Size |

ERSTE

| | | | | | |
|-----------|---|--------|-----------------|---------------|---------|
| EL0018699 | Lanternă reîncărcabilă LED BEVIS / Rechargeable LED flashlight BEVIS | 7x0.1W | Metal + Plastic | Negru / Black | 88x77mm |
|-----------|---|--------|-----------------|---------------|---------|



LED IP20

ERSTE

| | | | | | |
|-----------|---|---------|-----------------|--|-----------|
| EL0018705 | Lanternă reîncărcabilă LED HAZEL / Rechargeable LED flashlight HAZEL | 43x0.1W | Metal + Plastic | Negru + Transparent / Black + Transparent | 205x104mm |
|-----------|---|---------|-----------------|--|-----------|



LED IP20

ERSTE

| | | | | | |
|-----------|---|------|-----------------|--------------------------------|----------|
| EL0026436 | Lanternă reîncărcabilă LED GENOA / Rechargeable LED flashlight GENOA | 0.5W | Metal + Plastic | Verde + Alb / Green + White | 150x52mm |
|-----------|---|------|-----------------|--------------------------------|----------|



LED IP20

ERSTE

| | | | | | |
|-----------|--|----|-----------------|--------------------------------------|----------|
| EL0026437 | Lanternă reîncărcabilă LED JADER / Rechargeable LED lantern JADER | 2W | Metal + Plastic | Portocaliu + Alb / Orange + White | 70x170mm |
|-----------|--|----|-----------------|--------------------------------------|----------|

LED IP20



| RO | Cod | Denumire | Putere consumată | Material | Culoare | Dimensiune |
|----|------|----------|------------------|----------|---------|------------|
| EN | Code | Name | Power | Material | Color | Size |

ERSTE

| | | | | | |
|-----------|--|----|-----------------|----------------------------|----------|
| EL0026437 | Lanternă reîncărcabilă LED NARBO / Rechargeable LED flashlight NARBO | 1W | Metal + Plastic | Negru + Roșu / Black + Red | 240x85mm |
|-----------|--|----|-----------------|----------------------------|----------|

LED IP20



ERSTE

| | | | | | |
|-----------|--|-------|-----------------|-------------------------------|----------|
| EL0057156 | Lanternă reîncărcabilă LED KENNE / Rechargeable LED flashlight KENNE | 1W+1W | Metal + Plastic | Alb + Galben / White + Yellow | 155x50mm |
|-----------|--|-------|-----------------|-------------------------------|----------|

LED IP20



ERSTE

| | | | | | |
|-----------|---|---------------|-----------------|-------------------------------|----------|
| EL0067450 | Lanternă reîncărcabilă LED NEW ALICE / Rechargeable LED lantern NEW ALICE | 1x3W + 8x0,5W | Metal + Plastic | Alb + Galben / White + Yellow | 210x84mm |
|-----------|---|---------------|-----------------|-------------------------------|----------|

LED IP20



| RO | Cod | Denumire | Putere consumată | Flux luminos | Material | Culoare | Dimensiune |
|----|------|----------|------------------|---------------|----------|---------|------------|
| EN | Code | Name | Power | Luminous flux | Material | Color | Size |

ERSTE

| | | | | | | | |
|-----------|--|--------|------|-----------------|----------------------------|----------|----------|
| EL0073715 | | | 1W | - | | | 140x68mm |
| EL0083172 | Lanternă reîncărcabilă LED KIMY / Rechargeable LED flashlight KIMY | 7x0.1W | 80lm | Metal + Plastic | Negru + Roșu / Black + Red | 168x85mm | |
| EL0085892 | | | 5W | 550lm | | 160x92mm | |

LED IP20



HOMELIGHT

| | | | | | | |
|-----------|-------------------------------|----|------|---------|----------------------------|----------|
| EL0081072 | Lanternă LED / LED Flashlight | 1W | 50lm | Plastic | Negru + Roșu / Black + Red | 101x33mm |
|-----------|-------------------------------|----|------|---------|----------------------------|----------|

LED IP20



HOMELIGHT

| | | | | | | |
|-----------|-------------------------------|----|-------|---------|----------------------------|----------|
| EL0081073 | Lanternă LED / LED Flashlight | 2W | 200lm | Plastic | Negru + Roșu / Black + Red | 126x50mm |
|-----------|-------------------------------|----|-------|---------|----------------------------|----------|



PLAFONIERE INTERIOR DULIE

INDOOR CEILING LAMP WITH SOCKETS

RO

Plafonierele cu dulie sunt soluții simple și practice pentru iluminatul general al spațiilor interioare. Oferă flexibilitate în alegerea sursei de lumină și permit înlocuirea ușoară a becului atunci când este necesar.

REPERE

- **Bec ușor de înlocuit** – nu este nevoie să schimbi tot corpul de iluminat;
- **Utilizare versatilă** – potrivite pentru holuri, băi, scări sau spații de serviciu;
- **Întreținere redusă** – design simplu, durabil și accesibil.

EN

Ceiling lights with sockets are simple and practical solutions for general indoor lighting. They offer flexibility in choosing the light source and make bulb replacement quick and easy when needed.

FEATURES

- **Easy bulb replacement** – no need to replace the entire fixture;
- **Versatile use** – ideal for hallways, bathrooms, staircases, or utility areas;
- **Low maintenance** – simple, durable, and accessible design.

IP20



EL0030157



EL0030158



EL0030159



EL0030161



EL0030162



EL0030165



EL0030167



EL0030168

| RO | Cod | Denumire | Sursă | Dulie | Material | Culoare | Dimensiune |
|----|------|----------|--------|--------|----------|---------|------------|
| EN | Code | Name | Source | Socket | Material | Color | Size |

ERSTE

| | | | | | | |
|-----------|--|----------|-------|-------------|----------------------------------|---------------|
| EL0030157 | Plafonieră ANDRA / Ceiling lamp ANDRA | max. 60W | 1xE27 | Metal + MDF | Wenge + Crom / Wenge + Chrome | 150x170mm |
| EL0030158 | | | 2xE27 | | | 300/150x170mm |
| EL0030159 | | | 3xE27 | | | 450/150x170mm |
| EL0030161 | Plafonieră ANDRA / Ceiling lamp ANDRA | max. 60W | 1xE27 | Metal + MDF | Wenge | 150x170mm |
| EL0030162 | | | 3xE27 | | | 330x170mm |
| EL0030165 | | | 1xE27 | | | 300x80mm |
| EL0030167 | Plafonieră ANDRA / Ceiling lamp ANDRA | max. 60W | 1xE27 | Metal + MDF | Wenge | 300x80mm |
| EL0030168 | | | 2xE27 | | | 350x80mm |



Alte produse din familia ANDRA pot fi găsite la pagina 111.
Other products from the ANDRA family can be found on page 111.

IP20



| RO | Cod | Denumire | Sursă | Dulie | Material | Culoare | Dimensiune |
|----|------|----------|--------|--------|----------|---------|------------|
| EN | Code | Name | Source | Socket | Material | Color | Size |

ERSTE

| | | | | | | |
|-----------|--|----------|-------|-----------------------------------|-------------|----------|
| EL0075165 | Plafonieră TESERA / Ceiling lamp TESERA | max. 40W | 2xE27 | Metal + Sticlă / Metal + Glass | Alb / White | 300x85mm |
|-----------|--|----------|-------|-----------------------------------|-------------|----------|

IP20

**ERSTE**

| | | | | | | |
|-----------|--|----------|-------|-----------------------------------|-------------|----------|
| EL0075172 | Plafonieră WAVES / Ceiling lamp WAVES | max. 40W | 2xE27 | Metal + Sticlă / Metal + Glass | Alb / White | 300x85mm |
|-----------|--|----------|-------|-----------------------------------|-------------|----------|

IP20

**ERSTE**

| | | | | | | |
|-----------|--|----------|-------|-----------------------------------|-------------|-----------|
| EL0081826 | Plafonieră SENZOR / Ceiling lamp SENZOR | max. 40W | 2xE27 | Metal + Sticlă / Metal + Glass | Alb / White | 295x100mm |
|-----------|--|----------|-------|-----------------------------------|-------------|-----------|

IP20



| RO | Cod | Denumire | Sursă | Dulie | Material | Culoare | Dimensiune |
|----|------|----------|--------|--------|----------|---------|------------|
| EN | Code | Name | Source | Socket | Material | Color | Size |

ERSTE

| | | | | | | |
|-----------|--|----------|-------|-----------------------------------|-------------|----------|
| EL0076187 | Plafonieră CARLY / Ceiling lamp CARLY | max. 40W | 2xE27 | Metal + Sticlă / Metal + Glass | Alb / White | 300x85mm |
|-----------|--|----------|-------|-----------------------------------|-------------|----------|

IP20

**ERSTE**

| | | | | | | |
|-----------|--|----------|-------|-----------------------------------|-------------|----------|
| EL0076185 | Plafonieră CELIA / Ceiling lamp CELIA | max. 40W | 2xE27 | Metal + Sticlă / Metal + Glass | Alb / White | 300x85mm |
|-----------|--|----------|-------|-----------------------------------|-------------|----------|

IP20

**ERSTE**

| | | | | | | |
|-----------|--|----------|-------|-----------------------------------|-------------|----------|
| EL0076186 | Plafonieră FLORA / Ceiling lamp FLORA | max. 40W | 2xE27 | Metal + Sticlă / Metal + Glass | Alb / White | 300x85mm |
|-----------|--|----------|-------|-----------------------------------|-------------|----------|

IP20



| RO | Cod | Denumire | Sursă | Dulie | Material | Culoare | Dimensiune |
|----|------|----------|--------|--------|----------|---------|------------|
| EN | Code | Name | Source | Socket | Material | Color | Size |

ERSTE

| | | | | | | |
|-----------|--|----------|-------|-----------------------------------|-------------|----------|
| EL0075170 | Plafonieră FLOWER / Ceiling lamp FLOWER | max. 40W | 2xE27 | Metal + Sticlă / Metal + Glass | Alb / White | 300x85mm |
|-----------|--|----------|-------|-----------------------------------|-------------|----------|

IP20



ERSTE

| | | | | | | |
|-----------|--|----------|-------|-----------------------------------|-------------|----------|
| EL0075168 | Plafonieră MODERNA / Ceiling lamp MODERNA | max. 40W | 2xE27 | Metal + Sticlă / Metal + Glass | Alb / White | 300x85mm |
|-----------|--|----------|-------|-----------------------------------|-------------|----------|

IP20



ERSTE

| | | | | | | |
|-----------|--|----------|-------|-----------------------------------|-------------|----------|
| EL0076188 | Plafonieră SILK / Ceiling lamp SILK | max. 40W | 2xE27 | Metal + Sticlă / Metal + Glass | Alb / White | 300x85mm |
|-----------|--|----------|-------|-----------------------------------|-------------|----------|

IP20



| RO | Cod | Denumire | Sursă | Dulie | Material | Culoare | Dimensiune |
|----|------|----------|--------|--------|----------|---------|------------|
| EN | Code | Name | Source | Socket | Material | Color | Size |

ERSTE

| | | | | | | |
|-----------|--|----------|-------|-----------------------------------|-------------|-------|
| EL0075163 | Plafonieră DAHLIA / Ceiling lamp DAHLIA | max. 40W | 2xE27 | Metal + Sticlă / Metal + Glass | Alb / White | 300mm |
|-----------|--|----------|-------|-----------------------------------|-------------|-------|

IP20



ERSTE

| | | | | | | |
|-----------|--|----------|-------|--|-----------------|-----------|
| EL0040207 | | | | | Wenge | |
| EL0040208 | | | 4xE14 | | Antic / Antique | |
| EL0040209 | | | | | Nuc / Walnut | |
| EL0040210 | Plafonieră BENDIS / Ceiling lamp BENDIS | max. 40W | | Lemn și material textil alb/ Wood and white textile | Wenge | 170x260mm |
| EL0040211 | | | 2xE14 | | Antic / Antique | |
| EL0040212 | | | | | Nuc / Walnut | |
| EL0040210 | | | | | Wenge | |



Alte produse din familia BENDIS pot fi găsite la paginile 112, 134, 143.

Other products from the BENDIS family can be found on pages 112, 134, 143.



APLICĂ INTERIOR DULIE

INDOOR WALL LAMP WITH SOCKET

RO

Aplicele cu dulie sunt soluții elegante și versatile pentru iluminatul ambiental sau decorativ, oferind un plus de stil și funcționalitate în orice încăpere.

REPERE

- **Iluminare direcționată** – lumină focalizată sau difuză, adaptată nevoilor;
- **Design variat** – disponibile în multiple stiluri pentru integrare armonioasă;
- **Montaj facil** – instalare simplă pe perete, pentru un efect vizual plăcut.

EN

Wall lamps with sockets are elegant and versatile solutions for ambient or decorative lighting, adding style and functionality to any space.

FEATURES

- **Directional lighting** – focused or diffused light, adapted to your needs;
- **Varied designs** – available in multiple styles for seamless integration;
- **Easy installation** – simple wall mounting for an aesthetically pleasing effect.

IP20



| RO | Cod | Denumire | Sursă | Dulie | Material | Culoare | Dimensiune |
|----|------|----------|--------|--------|----------|---------|------------|
| EN | Code | Name | Source | Socket | Material | Color | Size |

ERSTE

| | | | | | | |
|-----------|-----------------------------------|----------|-------|-------------|---------------------------------|---------------|
| EL0030164 | Aplică ANDRA / Wall lamp ANDRA | max. 60W | 1xE27 | Metal + MDF | Wenge + Crom/ Wenge + Chrome | 200/150x170mm |
|-----------|-----------------------------------|----------|-------|-------------|---------------------------------|---------------|



Alte produse din familia ANDRA pot fi găsite la pagina 105.
Other products from the ANDRA family can be found on page 105.



IP20

ERSTE

| | | | | | | |
|-----------|-----------------------------------|----------|-------|--------------------------------------|--------------------------------|---------------|
| EL0033963 | Aplică ELADA / Wall lamp ELADA | max. 60W | 1xE27 | Metal și Sticlă / Metal and glass | Alb + Wenge / White + Wenge | 180/120x210mm |
|-----------|-----------------------------------|----------|-------|--------------------------------------|--------------------------------|---------------|



Alte produse din familia ELADA se găsesc la pagina 129.
Other products from the ELADA family can be found on page 129.

IP20



| RO | Cod | Denumire | Sursă | Dulie | Material | Culoare | Dimensiune |
|--------------|-----------|-----------------------------------|----------|--------|------------------------------------|-----------------|------------|
| EN | Code | Name | Source | Socket | Material | Color | Size |
| ERSTE | | | | | | | |
| | EL0020193 | Aplică DAVOS / Wall lamp DAVOS | max. 40W | 1xE14 | Lemn și sticlă / Wood and glass | Wenge | 200x210mm |
| | EL0027090 | | | | | Antic / Antique | |
| | EL0027832 | | | 2xE14 | | Nuc / Walnut | 250x210mm |
| | EL0029892 | | | | | Antic / Antique | |
| | EL0030419 | | | 1xE14 | | Nuc / Walnut | 200x210mm |
| | EL0020330 | | | 2xE14 | | Wenge | 250x210mm |

i Alte produse din familia DAVOS pot fi găsite la pagina 133.
Other products from the DAVOS family can be found on page 133.



IP20

| RO | Cod | Denumire | Sursă | Dulie | Material | Culoare | Dimensiune |
|--------------|-----------|-------------------------------------|----------|--------|--|-----------------|------------|
| EN | Code | Name | Source | Socket | Material | Color | Size |
| ERSTE | | | | | | | |
| | EL0021349 | Aplică BENDIS / Wall lamp BENDIS | max. 40W | 1xE14 | Lemn și material textil alb/ Wood and white textile | Antic / Antique | 160x170mm |
| | EL0025144 | | | | | Nuc / Walnut | 170x260mm |
| | EL0039151 | | | 2xE14 | | Antic / Antique | 160x170mm |
| | EL0020413 | | | | | Nuc / Walnut | |
| | EL0020012 | | | 1xE14 | | Wenge | 160x170mm |
| | EL0020009 | | | | | | 2xE14 |

i Alte produse din familia BENDIS pot fi găsite la paginile 109, 134, 143.
Other products from the BENDIS family can be found on pages 109, 134, 143.

IP20



| RO | Cod | Denumire | Sursă | Dulie | Material | Culoare | Dimensiune |
|--------------|-----------|-----------------------------------|----------|--------|--|--------------|-----------------|
| EN | Code | Name | Source | Socket | Material | Color | Size |
| ERSTE | | | | | | | |
| | EL0030420 | Aplică SINNA / Wall lamp SINNA | max. 40W | 1xE14 | Lemn + Sticlă albă / Wood + White glass | Nuc / Walnut | 200x210mm |
| | EL0030542 | | | Wenge | | 210x210mm | |
| | EL0039143 | | | 2xE14 | | | Nuc / Walnut |
| | EL0039144 | | | | | | Antic / Antique |

i Alte produse din familia SINNA pot fi găsite la pagina 135.
Other products from the SINNA family can be found on page 135.

IP20



| RO | Cod | Denumire | Sursă | Dulie | Material | Culoare | Dimensiune |
|--------------|-----------|---------------------------------------|----------|--------|--|-----------------------------------|------------|
| EN | Code | Name | Source | Socket | Material | Color | Size |
| ERSTE | | | | | | | |
| | EL0038888 | Aplică PANDORA / Wall lamp PANDORA | max. 60W | 1xE14 | Metal + Cristale / Metal + Crystals | Alb antichizat / Antique white | 380x220mm |
| | EL0038889 | | | 2xE14 | | | 380x365mm |

i Alte produse din familia PANDORA pot fi găsite la pagina 139.
Other products from the PANDORA family can be found on page 139.

IP20



| RO | Cod | Denumire | Sursă | Dulie | Material | Culoare | Dimensiune |
|--------------|-----------|-------------------------------------|----------|-----------------|--|-----------------|------------|
| EN | Code | Name | Source | Socket | Material | Color | Size |
| ERSTE | | | | | | | |
| | EL0020136 | Aplică ELARIA / Wall lamp ELARIA | max. 40W | 1xE14 | Lemn + Sticlă albă / Wood + White glass | Wenge | 150x210mm |
| | EL0020139 | | | | | Antic / Antique | |
| | EL0021366 | | | Antic / Antique | | 2xE14 | 210x220mm |
| | EL0024499 | | | Wenge | | | |
| | EL0025601 | | | Nuc / Walnut | | 3xE14 | 370x400mm |
| | EL0020393 | | | Antic / Antique | | | |
| | EL0027833 | | | Nuc / Walnut | | | |
| | EL0028030 | | | Wenge | | 1xE14 | 210x150mm |
| | EL0030422 | Nuc / Walnut | | | | | |

i Alte produse din familia ELARIA pot fi găsite la pagina 132.
Other products from the ELARIA family can be found on page 132.

IP20



| RO | Cod | Denumire | Sursă | Dulie | Material | Culoare | Dimensiune |
|--------------|-----------|-------------------------------------|----------|--------|-----------------------------------|---------------|---------------|
| EN | Code | Name | Source | Socket | Material | Color | Size |
| ERSTE | | | | | | | |
| | EL0028514 | Aplică RAMONA / Wall lamp RAMONA | max. 60W | 1xE27 | Metal + Sticlă / Metal + Glass | Wenge / wenge | 230/140x190mm |

i Alte produse din familia RAMONA pot fi găsite la pagina 131.
Other products from the RAMONA family can be found on page 131.



| RO | Cod | Denumire | Sursă | Dulie | Material | Culoare | Dimensiune |
|--------------|-----------|-------------------------------------|----------|--------|-----------------------------------|--------------------------------|---------------|
| EN | Code | Name | Source | Socket | Material | Color | Size |
| ERSTE | | | | | | | |
| | EL0028512 | Aplică SILVIA / Wall lamp SILVIA | max. 60W | 1xE27 | Metal + Sticlă / Metal + Glass | Crom + alb / Chrome + white | 210/110x200mm |

i Alte produse din familia SILVIA pot fi găsite la pagina 127.
Other products from the SILVIA family can be found on page 127.



| RO | Cod | Denumire | Sursă | Dulie | Material | Culoare | Dimensiune |
|--------------|-----------|-----------------------------------|----------|--------|-----------------------------------|--------------------------------|---------------|
| EN | Code | Name | Source | Socket | Material | Color | Size |
| ERSTE | | | | | | | |
| | EL0028511 | Aplică TANIA / Wall lamp TANIA | max. 60W | 1xE27 | Metal + Sticlă / Metal + Glass | Crom + alb / Chrome + white | 160/110x190mm |

i Alte produse din familia TANIA pot fi găsite la pagina 139.
Other products from the TANIA family can be found on page 139.

IP20



| RO | Cod | Denumire | Sursă | Dulie | Material | Culoare | Dimensiune |
|----|------|----------|--------|--------|----------|---------|------------|
| EN | Code | Name | Source | Socket | Material | Color | Size |

ERSTE

| | | | | | | |
|-----------|---------------------------------|----------|-------|-----------------------------------|-------------|-----------|
| EL0081438 | Aplică FARE / Wall lamp FARE | max. 60W | 1xE27 | Metal + Sticlă / Metal + Glass | Alb / White | 280x190mm |
|-----------|---------------------------------|----------|-------|-----------------------------------|-------------|-----------|

i Alte produse din familia FARE pot fi găsite la pagina 129.
Other products from the FARE family can be found on page 129.



IP20

ERSTE

| | | | | | | |
|-----------|---------------------------------|----------|-------|-------|-----------------------------------|-----------|
| EL0038220 | Aplică JUNO / Wall lamp JUNO | max. 60W | 1xE27 | Metal | Alb antichizat / Antique white | 160x195mm |
|-----------|---------------------------------|----------|-------|-------|-----------------------------------|-----------|

i Alte produse din familia JUNO pot fi găsite la pagina 128.
Other products from the JUNO family can be found on page 128.



IP20

ERSTE

| | | | | | | |
|-----------|---------------------------------|----------|-------|---------------------------------|--------------------------------|---------------|
| EL0081440 | Aplică LENA / Wall lamp LENA | max. 60W | 1xE27 | Sticlă + Lemn / Glass + Wood | Natur + alb / Natur + white | 190x130x190mm |
|-----------|---------------------------------|----------|-------|---------------------------------|--------------------------------|---------------|

i Alte produse din familia LENA pot fi găsite la pagina 134.
Other products from the LENA family can be found on page 134.

IP20



| RO | Cod | Denumire | Sursă | Dulie | Material | Culoare | Dimensiune |
|----|------|----------|--------|--------|----------|---------|------------|
| EN | Code | Name | Source | Socket | Material | Color | Size |

ERSTE

| | | | | | | |
|-----------|---------------------------------|----------|-------|-----------------|-------------|-----------|
| EL0081457 | Aplică LUMA / Wall lamp LUMA | max. 60W | 1xE14 | Metal + Plastic | Alb / White | 150x170mm |
|-----------|---------------------------------|----------|-------|-----------------|-------------|-----------|

i Alte produse din familia LUMA pot fi găsite la pagina 127.
Other products from the LUMA family can be found on page 127.



IP20

ERSTE

| | | | | | | |
|-----------|-----------------------------------|----------|-------|-----------------------------------|----------------------------------|-----------|
| EL0038082 | Aplică NIEGE / Wall lamp NIEGE | max. 60W | 1xE27 | Metal + Sticlă / Metal + Glass | Negru + Crom / Black + Chrome | 190x210mm |
|-----------|-----------------------------------|----------|-------|-----------------------------------|----------------------------------|-----------|

i Alte produse din familia NIEGE pot fi găsite la pagina 130.
Other products from the NIEGE family can be found on page 130.



IP20

ERSTE

| | | | | | | |
|-----------|-----------------------------------|----------|-------|-----------------------------------|--------------------------------|---------------|
| EL0034044 | Aplică OSAKA / Wall lamp OSAKA | max. 60W | 1xE14 | Metal + Sticlă / Metal + Glass | Alb + wenge / White + wenge | 220/150x250mm |
|-----------|-----------------------------------|----------|-------|-----------------------------------|--------------------------------|---------------|

i Alte produse din familia OSAKA pot fi găsite la pagina 131.
Other products from the OSAKA family can be found on page 131.

IP20



| RO | Cod | Denumire | Sursă | Dulie | Material | Culoare | Dimensiune |
|----|------|----------|--------|--------|----------|---------|------------|
| EN | Code | Name | Source | Socket | Material | Color | Size |

ERSTE

| | | | | | | |
|-----------|-----------------------------------|----------|-------|-----------------|--------------------------------|-----------|
| EL0081458 | Aplică GLACE / Wall lamp GLACE | max. 60W | 1xE14 | Metal + Plastic | Negru + Alb / Black + White | 200x280mm |
| EL0081459 | | | 2xE14 | | | 200x450mm |



Alte produse din familia GLACE pot fi găsite la pagina 122.
Other products from the GLACE family can be found on page 122.



IP20

ERSTE

| | | | | | | |
|-----------|-----------------------------------|----------|-------|-----------------------------------|-----------------|-----------|
| EL0081435 | Aplică SMOKY / Wall lamp SMOKY | max. 60W | 1xE27 | Metal + Sticlă / Metal + Glass | Fumuriu / Smoky | 300x280mm |
|-----------|-----------------------------------|----------|-------|-----------------------------------|-----------------|-----------|



Alte produse din familia SMOKY pot fi găsite la pagina 138.
Other products from the SMOKY family can be found on page 138.





PENDULE INTERIOR DULIE

INDOOR PENDANT WITH SOCKET

RO

Pendulele cu dulie sunt corpuri de iluminat moderne și versatile, potrivite pentru livinguri, bucătării sau spații comerciale, oferind un echilibru între estetică și funcționalitate.

REPERE

- **Design rafinat** – disponibile în diverse stiluri și finisaje;
- **Iluminare focalizată** – perfecte pentru zone de lucru sau relaxare;
- **Montaj simplu** – ușor de instalat și adaptabil diverselor configurații.

EN

Pendant lights with sockets are modern and versatile fixtures, perfect for living rooms, kitchens, or commercial spaces, offering a balance between aesthetics and functionality.

FEATURES

- **Refined design** – available in various styles and finishes;
- **Focused lighting** – ideal for work areas or relaxation zones;
- **Easy installation** – simple setup and adaptable to different configurations.

IP20



| RO | Cod | Denumire | Sursă | Dulie | Material | Culoare | Dimensiune |
|----|------|----------|--------|--------|----------|---------|------------|
| EN | Code | Name | Source | Socket | Material | Color | Size |

ERSTE

| | | | | | | |
|-----------|-------------------------------|----------|-------|-----------------------------------|--------------------------------|-----------|
| EL0028727 | Pendul DECA / Pendant DECA | max. 60W | 1xE27 | Metal + Sticlă / Metal + Glass | Crom + alb / Chrome + white | 300x500mm |
|-----------|-------------------------------|----------|-------|-----------------------------------|--------------------------------|-----------|



IP20

ERSTE

| | | | | | | |
|-----------|-----------------------------------|----------|-------|-----------------------------------|---------------------------------------|------------|
| EL0029474 | Pendul EDISON / Pendant EDISON | max. 60W | 1xE27 | Metal + Sticlă / Metal + Glass | Bronz antichizat / Antiqued bronze | 150x1000mm |
| EL0029480 | | | | Metal | | 260x1000mm |



IP20

ERSTE

| | | | | | | |
|-----------|---------------------------------|----------|-------|-----------------------------------|--------------------------------|------------|
| EL0038532 | Pendul FLARE / Pendant FLARE | max. 60W | 1xE27 | Metal + sticlă / Metal + Glass | Crom + alb / Chrome + white | 1000x120mm |
|-----------|---------------------------------|----------|-------|-----------------------------------|--------------------------------|------------|



IP20

ERSTE

| | | | | | | |
|-----------|-----------------------------------|----------|-------|-------|--|------------|
| EL0038211 | Pendul FUSION / Pendant FUSION | max. 60W | 1xE27 | Metal | Alb cu interior portocaliu / White with orange interior | 1210x210mm |
|-----------|-----------------------------------|----------|-------|-------|--|------------|

IP20



| RO | Cod | Denumire | Sursă | Dulie | Material | Culoare | Dimensiune |
|----|------|----------|--------|--------|----------|---------|------------|
| EN | Code | Name | Source | Socket | Material | Color | Size |

ERSTE

| | | | | | | |
|-----------|---------------------------------|----------|-------|-----------------------------------|--------------------------------|----------------|
| EL0081454 | Pendul GLACE / Pendant GLACE | max. 60W | 1xE27 | Metal + Sticlă / Metal + Glass | Negru + Alb / Black + White | 200x1500mm |
| EL0081455 | | | 3xE27 | | | 600x130x1000mm |

i Alte produse din familia GLACE pot fi găsite la pagina 118.
Other products from the GLACE family can be found on page 118.



IP20

ERSTE

| | | | | | | |
|-----------|---------------------------------|----------|-------|-----------------------------------|---------------|------------|
| EL0081448 | Pendul GLINT / Pendant GLINT | max. 60W | 1xE27 | Metal + Sticlă / Metal + Glass | Negru / Black | 200x1000mm |
| EL0081449 | | | | | Crom / Chrome | |
| EL0081450 | | | | | Negru / Black | |



IP20

ERSTE

| | | | | | | |
|-----------|-------------------------------|----------|-------|---------------------------------|-------------------------------|-----------|
| EL0038492 | Pendul JADE / Pendant JADE | max. 40W | 1xE27 | Lemn + Sticlă / Wood + Glass | Maro + Alb / Brown + White | 750x190mm |
| EL0038493 | | | 3xE27 | | | 750x380mm |

IP20

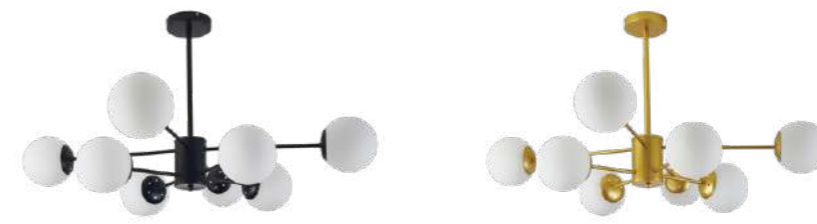

| RO | Cod | Denumire | Sursă | Dulie | Material | Culoare | Dimensiune |
|----|------|----------|--------|--------|----------|---------|------------|
| EN | Code | Name | Source | Socket | Material | Color | Size |

ERSTE

| | | | | | | |
|-----------|-------------------------------|----------|-------|-----------------------------------|--------------------------------|-----------|
| EL0081460 | Pendul LACE / Pendant LACE | max. 60W | 8xE27 | Metal + Sticlă / Metal + Glass | Negru + Alb / Black + White | 890x495mm |
| EL0081461 | | | | | Auriu + Alb / Gold + White | |



IP20

ERSTE

| | | | | | | |
|-----------|---|----------|-------|-------|--|------------|
| EL0038541 | Pendul MINIMALIST / Pendant MINIMALIST | max. 60W | 1xE27 | Metal | Negru cu interior portocaliu / Black with orange interior | 1050x400mm |
|-----------|---|----------|-------|-------|--|------------|



IP20

ERSTE

| | | | | | | |
|-----------|---------------------------------|----------|-------|-----------------------------------|---------------|------------|
| EL0033954 | Pendul MODUS / Pendant MODUS | max. 40W | 1xE27 | Metal + Sticlă / Metal + Glass | Negru / Black | 300x1000mm |
|-----------|---------------------------------|----------|-------|-----------------------------------|---------------|------------|



IP20

ERSTE

| | | | | | | |
|-----------|-------------------------------|----------|-------|-----------------------------------|--------------|--------------------|
| EL0075187 | Pendul NALA / Pendant NALA | max. 40W | 1xE14 | Metal + sticlă / Metal + Glass | Auriu / Gold | 1400x150x450x100mm |
|-----------|-------------------------------|----------|-------|-----------------------------------|--------------|--------------------|

IP20



| RO | Cod | Denumire | Sursă | Dulie | Material | Culoare | Dimensiune |
|----|------|----------|--------|--------|----------|---------|------------|
| EN | Code | Name | Source | Socket | Material | Color | Size |

ERSTE

| | | | | | | |
|-----------|-------------------------------|----------|-------|-----------------------------------|--------------|--------------------|
| EL0075188 | Pendul NULI / Pendant NULI | max. 40W | 1xE14 | Metal + Sticlă / Metal + Glass | Auriu / Gold | 1400x200x430x100mm |
|-----------|-------------------------------|----------|-------|-----------------------------------|--------------|--------------------|

IP20



ERSTE

| | | | | | | |
|-----------|-----------------------------------|----------|------------|--------------------------------|---------------|------------|
| EL0081452 | Pendul PLAYER / Pendant PLAYER | max. 60W | 1xE27 | Metal + Lemn / Metal + Wood | Negru / Black | 170x1000mm |
| EL0081453 | 3xE27 | | 630x1000mm | | | |

IP20



ERSTE

| | | | | | | |
|-----------|-------------------------------|----------|-------|-----------------|---------------|-----------|
| EL0081451 | Pendul SPOT / Pendant SPOT | max. 60W | 1xE27 | Metal + Plastic | Negru / Black | 80x1000mm |
|-----------|-------------------------------|----------|-------|-----------------|---------------|-----------|

IP20



| RO | Cod | Denumire | Sursă | Dulie | Material | Culoare | Dimensiune |
|----|------|----------|--------|--------|----------|---------|------------|
| EN | Code | Name | Source | Socket | Material | Color | Size |

ERSTE

| | | | | | | |
|-----------|-----------------------------------|----------|-------|-----------------------------------|--------------------------------|------------|
| EL0038546 | Pendul TURING / Pendant TURING | max. 60W | 1xE27 | Metal + Sticlă / Metal + Glass | Negru + Alb / Black + White | 1100x370mm |
|-----------|-----------------------------------|----------|-------|-----------------------------------|--------------------------------|------------|

IP20



ERSTE

| | | | | | | |
|-----------|-----------------------------------|----------|-------|-----------------------------------|-------------|------------|
| EL0033955 | Pendul INSTAR / Pendant INSTAR | max. 40W | 1xE27 | Metal + Sticlă / Metal + Glass | Alb / White | 300x1000mm |
|-----------|-----------------------------------|----------|-------|-----------------------------------|-------------|------------|

IP20



ERSTE

| | | | | | | |
|-----------|-------------------------------|----------|-------|--------------------------------|-----------------|---------------|
| EL0068972 | Pendul XARA / Pendant XARA | max. 60W | 1xE27 | Lemn + Sfoară / Wood + Rope | Antic / Antique | 250x250x850mm |
| EL0068973 | | | 2xE27 | | | 500x250x850mm |
| EL0068974 | | | 3xE27 | | | 710x250x850mm |



LUSTRE INTERIOR DULIE

INDOOR CHANDELIER WITH SOCKET

RO

Lustrele cu dulie sunt elemente decorative de impact, perfecte pentru a adăuga eleganță și rafinament spațiilor interioare.

REPERE

- Aspect sofisticat – ideale pentru interioare elegante și luxoase;
- Iluminare amplă – distribuție eficientă a luminii în întreaga cameră;
- Modele variate – disponibile în multiple dimensiuni și stiluri.

EN

Chandeliers with sockets are impactful decorative elements, perfect for adding elegance and refinement to interior spaces.

FEATURES

- Sophisticated look – ideal for elegant and luxurious interiors;
- Ample lighting – efficient light distribution throughout the room;
- Varied models – available in multiple sizes and styles.

IP20



| RO | Cod | Denumire | Sursă | Dulie | Material | Culoare | Dimensiune |
|----|------|----------|--------|--------|----------|---------|------------|
| EN | Code | Name | Source | Socket | Material | Color | Size |

ERSTE

| | | | | | | |
|-----------|----------------------------------|----------|-------|-----------------------------------|---------------|-----------|
| EL0037971 | Lustră ARIA / Chandelier ARIA | max. 60W | 2xE27 | Metal + Sticlă / Metal + Glass | Negru / Black | 260x360mm |
| EL0037972 | | | 3xE27 | | | 260x560mm |

IP20



ERSTE

| | | | | | | |
|-----------|--------------------------------------|----------|-------|-----------------------------------|--------------------------------|-----------|
| EL0023788 | Lustră SILVIA / Chandelier SILVIA | max. 60W | 5xE27 | Metal + Sticlă / Metal + Glass | Crom + Alb / Chrome + White | 530x220mm |
| EL0023797 | | | 3xE27 | | | 440x220mm |
| EL0023784 | | | 2xE27 | | | 560x220mm |



Alte produse din familia SILVIA pot fi găsite la pagina 115.

Other products from the SILVIA family can be found on page 115.



IP20

ERSTE

| | | | | | | |
|-----------|----------------------------------|----------|-------|-----------------------------------|---------------------------------|---------------|
| EL0081456 | Lustră LUMA / Chandelier LUMA | max. 60W | 2xE27 | Metal + Sticlă / Metal + Glass | Negru + Auriu / Black + Gold | 420x280x225mm |
|-----------|----------------------------------|----------|-------|-----------------------------------|---------------------------------|---------------|



Alte produse din familia LUMA pot fi găsite la pagina 117.

Other products from the LUMA family can be found on page 117.

IP20



| RO | Cod | Denumire | Sursă | Dulie | Material | Culoare | Dimensiune |
|----|------|----------|--------|--------|----------|---------|------------|
| EN | Code | Name | Source | Socket | Material | Color | Size |

ERSTE

| | | | | | | |
|-----------|--|----------|-------|-----------------------------------|--------------------------------|---------------|
| EL0034077 | Lustră FLANDRA / Chandelier FLANDRA | max. 60W | 2xE27 | Metal + Sticlă / Metal + Glass | Alb + Alamă / White + Brass | 420x220mm |
| EL0034078 | | | 3xE27 | | Alb + Alamă / White + Brass | 550x170x220mm |

IP20



ERSTE

| | | | | | | |
|-----------|----------------------------------|----------|-------|-------|-----------------------------------|-----------|
| EL0038221 | Lustră JUNO / Chandelier JUNO | max. 60W | 2xE27 | Metal | Alb antichizat / Antique white | 270x430mm |
| EL0038222 | | | 3xE27 | | | 430x270mm |



Alte produse din familia JUNO pot fi găsite la pagina 116.
Other products from the JUNO family can be found on page 116.

IP20



| RO | Cod | Denumire | Sursă | Dulie | Material | Culoare | Dimensiune |
|----|------|----------|--------|--------|----------|---------|------------|
| EN | Code | Name | Source | Socket | Material | Color | Size |

ERSTE

| | | | | | | |
|-----------|------------------------------------|----------|-------|-----------------------------------|--------------------------------|---------------|
| EL0033964 | Lustră ELADA / Chandelier ELADA | max. 60W | 2xE27 | Metal + Sticlă / Metal + Glass | Alb + Wenge / White + Wenge | 490/120x250mm |
| EL0033965 | | | 3xE27 | | | 590/120x250mm |



Alte produse din familia ELADA se găsesc la pagina 111.
Other products from the ELADA family can be found on page 111.

IP20



ERSTE

| | | | | | | |
|-----------|------------------------------------|----------|-------|-----------------------------------|----------------------------------|-----------|
| EL038063 | Lustră KYOTO / Chandelier KYOTO | max. 60W | 3xE27 | Metal + Sticlă / Metal + Glass | Negru + Crom / Black + Chrome | 670x291mm |
| EL0038062 | | | 2xE27 | | | 420x291mm |

IP20



ERSTE

| | | | | | | |
|-----------|----------------------------------|----------|-------|-----------------------------------|-------------|-----------|
| EL0081439 | Lustră FARE / Chandelier FARE | max. 60W | 3xE27 | Metal + Sticlă / Metal + Glass | Alb / White | 540x340mm |
|-----------|----------------------------------|----------|-------|-----------------------------------|-------------|-----------|



Alte produse din familia FARE pot fi găsite la pagina 116.
Other products from the FARE family can be found on page 116.

IP20



| RO | Cod | Denumire | Sursă | Dulie | Material | Culoare | Dimensiune |
|----|------|----------|--------|--------|----------|---------|------------|
| EN | Code | Name | Source | Socket | Material | Color | Size |

ERSTE

| | | | | | | |
|-----------|------------------------------------|----------|-------|-----------------------------------|--------------------------------|-----------|
| EL0081446 | Lustră MILKY / Chandelier MILKY | max. 60W | 2xE27 | Metal + Sticlă / Metal + Glass | Alb + Alamă / White + Brass | 350x255mm |
| EL0081447 | | | 3xE27 | | | 420x265mm |



IP20

ERSTE

| | | | | | | |
|-----------|------------------------------------|----------|-------|-----------------------------------|----------------------------------|-----------|
| EL0038083 | Lustră NIEGE / Chandelier NIEGE | max. 60W | 2xE27 | Metal + Sticlă / Metal + Glass | Negru + Crom / Black + Chrome | 400x280mm |
| EL0038084 | | | 4xE27 | | | 370x280mm |

i Alte produse din familia NIEGE pot fi găsite la pagina 117.
Other products from the NIEGE family can be found on page 117.



IP20

ERSTE

| | | | | | | |
|-----------|--------------------------------------|----------|-------|---|-------------|---------------|
| EL0061126 | Lustră NORDIK / Chandelier NORDIK | max. 40W | 1xE14 | Metal + Lemn + Textil / Metal + Wood + Textile | Alb / White | 140x131x120mm |
| EL0061127 | | | 2xE14 | | | 320x131x250mm |
| EL0061128 | | | 3xE14 | | | 540x131x470mm |

IP20



| RO | Cod | Denumire | Sursă | Dulie | Material | Culoare | Dimensiune |
|----|------|----------|--------|--------|----------|---------|------------|
| EN | Code | Name | Source | Socket | Material | Color | Size |

ERSTE

| | | | | | | |
|-----------|------------------------------------|----------|-------|-----------------------------------|--------------------------------|---------------|
| EL0034045 | Lustră OSAKA / Chandelier OSAKA | max. 60W | 2xE27 | Metal + Sticlă / Metal + Glass | Alb + Wenge / White + Wenge | 470/150x250mm |
| EL0034046 | | | 3xE27 | | | 570/180x250mm |
| EL0034047 | | | 4xE27 | | | 600/380x250mm |

i Alte produse din familia OSAKA pot fi găsite la pagina 117.
Other products from the OSAKA family can be found on page 117.



IP20

ERSTE

| | | | | | | |
|-----------|--------------------------------------|---------|-------|-----------------------------------|--------------------------------|---------------|
| EL0023842 | Lustră RAMONA / Chandelier RAMONA | max.60W | 2xE27 | Metal + Sticlă / Metal + Glass | Alb + Wenge / White + Wenge | 560/170x210mm |
| EL0023843 | | | 3xE27 | | | 440x220mm |
| EL0023844 | | | 5xE27 | | | 530x210mm |

i Alte produse din familia RAMONA pot fi găsite la pagina 115.
Other products from the RAMONA family can be found on page 115.

IP20



| RO | Cod | Denumire | Sursă | Dulie | Material | Culoare | Dimensiune |
|----|------|----------|--------|--------|----------|---------|------------|
| EN | Code | Name | Source | Socket | Material | Color | Size |

ERSTE

| | | | | | | |
|-----------|--------------------------------------|----------|--|-------|-----------------|-----------|
| EL0017749 | Lustră ELARIA / Chandelier ELARIA | max. 40W | Lemn + Sticlă albă / Wood + White glass | 5xE14 | Antic / Antique | 500x600mm |
| EL0017775 | | | | 5xE14 | Wenge | 500x600mm |
| EL0017776 | | | | 3xE14 | 500x600mm | |
| EL0020183 | | | | 5XE14 | Nuc / Walnut | 600x670mm |
| EL0020391 | | | | 2xE14 | Antic / Antique | 300x600mm |
| EL0020392 | | | | 5xE14 | 600x670mm | |
| EL0025484 | | | | 2xE14 | Wenge | 300x600mm |
| EL0039147 | | | | 2xE14 | Nuc / Walnut | 600x300mm |
| EL0039148 | | | | 3xE14 | 600x500mm | |
| EL0039149 | | | | 3xE14 | Antic / Antique | 600x500mm |
| EL0020135 | | | | 5xE14 | Nuc / Walnut | 500x600mm |
| EL0025484 | | | | 2xE14 | 300x600mm | |
| EL0017897 | | | | 5xE14 | Wenge | 670x600mm |

i Alte produse din familia ELARIA pot fi găsite la pagina 114.
Other products from the ELARIA family can be found on page 114.

IP20



| RO | Cod | Denumire | Sursă | Dulie | Material | Culoare | Dimensiune |
|----|------|----------|--------|--------|----------|---------|------------|
| EN | Code | Name | Source | Socket | Material | Color | Size |

ERSTE

| | | | | | | | |
|-----------|------------------------------------|----------|--|-------|-----------------|--------------|-----------|
| EL0018351 | Lustră DAVOS / Chandelier DAVOS | max. 40W | Lemn + Sticlă albă / Wood + White glass | 3xE14 | Wenge | 400x600mm | |
| EL0018353 | | | | 4xE14 | | 500x600mm | |
| EL0025600 | | | | 6xE14 | | 650x600mm | |
| EL0018555 | | | | 8xE14 | | 670x600mm | |
| EL0017750 | | | | 3xE14 | | 400x600mm | |
| EL0029151 | | | | 4xE14 | | 500x600mm | |
| EL0029152 | | | | 6xE14 | Antic / Antique | 650x600mm | |
| EL0039150 | | | | 8xE14 | | 670x600mm | |
| EL0028653 | | | | 3xE14 | | Nuc / Walnut | 400x600mm |
| EL0025671 | | | | 4xE14 | | | 500x600mm |
| EL0031718 | | | | 6xE14 | 650x600mm | | |
| EL0025016 | | | | 8xE14 | 670x600mm | | |

i Alte produse din familia DAVOS pot fi găsite la pagina 112.
Other products from the DAVOS family can be found on page 112.

IP20



| RO | Cod | Denumire | Sursă | Dulie | Material | Culoare | Dimensiune |
|----|------|----------|--------|--------|----------|---------|------------|
| EN | Code | Name | Source | Socket | Material | Color | Size |

ERSTE

| | | | | | | | |
|-----------|-----------------------------------|----------|-------|--|--------------|-----------------|---------------|
| EL0021348 | | | | | | Antic / Antique | |
| EL0020414 | Lustră BENDIS / Chandelier BENDIS | max. 40W | 4xE14 | Lemn și material textil alb / Wood and white textile | Nuc / Walnut | | 400x400x350mm |
| EL0020008 | | | | | Wenge | | |

i Alte produse din familia BENDIS pot fi găsite la paginile 109, 112, 143.
Other products from the BENDIS family can be found on pages 109, 112, 143.

**ERSTE**

| | | | | | | | |
|-----------|-------------------------------|----------|-------|--------------------------------|------------------------------|--|-----------|
| EL0081441 | Lustră LENA / Chandelier LENA | max. 60W | 3xE27 | Metal + Sticlă / Metal + Glass | Natur + Alb / Nature + White | | 440x210mm |
|-----------|-------------------------------|----------|-------|--------------------------------|------------------------------|--|-----------|

i Alte produse din familia LENA pot fi găsite la pagina 116.
Other products from the LENA family can be found on page 116.

IP20

IP20



| RO | Cod | Denumire | Sursă | Dulie | Material | Culoare | Dimensiune |
|----|------|----------|--------|--------|----------|---------|------------|
| EN | Code | Name | Source | Socket | Material | Color | Size |

ERSTE

| | | | | | | | |
|-----------|---------------------------------|----------|-------|--|------------------------------|-----------------|---------------|
| EL0024497 | Veioză SINNA / Lamps SINNA | max. 40W | 1xE14 | | | Wenge | 180x220mm |
| EL0028397 | | | | | Lemn + Sticlă / Wood + Glass | | |
| EL0029893 | Lustră SINNA / Chandelier SINNA | max. 40W | 2xE14 | | | Antic / Antique | 200/350x600mm |
| EL0030421 | | | | | | Nuc / Walnut | |

i Alte produse din familia SINNA pot fi găsite la pagina 113.
Other products from the SINNA family can be found on page 113.

IP20



| RO | Cod | Denumire | Sursă | Dulie | Material | Culoare | Dimensiune |
|----|------|----------|--------|--------|----------|---------|------------|
| EN | Code | Name | Source | Socket | Material | Color | Size |

ERSTE

| | | | | | | |
|-----------|----------------------------------|----------|-------|--------------------------------|-----------------|-----------|
| EL0069193 | Lustră BARI / Chandelier BARI | max. 60W | 1xE27 | Lemn + Sfoară / Wood + Rope | Antic / Antique | 900x70mm |
| EL0069195 | | | 3xE27 | | | 600x290mm |
| EL0069196 | | | 6XE27 | 600x600mm | | |
| EL0069194 | | | 3xE27 | Lemn / Wood | | 600x290mm |

IP20



| RO | Cod | Denumire | Sursă | Dulie | Material | Culoare | Dimensiune |
|----|------|----------|--------|--------|----------|---------|------------|
| EN | Code | Name | Source | Socket | Material | Color | Size |

ERSTE

| | | | | | | |
|-----------|---------------------------------------|----------|-------|--------------------------------|-----------------|--------------|
| EL0069201 | Suspensie LUCCA / Chandelier LUCCA | max. 60W | 3xE27 | Lemn + Sfoară / Wood + Rope | Antic / Antique | 700x70x900mm |
| EL0069199 | Suspensie LUCCA / Suspension LUCCA | | 2xE27 | | | 300x70x600mm |
| EL0069200 | Suspensie LUCCA / Suspension LUCCA | | 3xE27 | | | 400x70x600mm |

IP20



| RO | Cod | Denumire | Sursă | Dulie | Material | Culoare | Dimensiune |
|----|------|----------|--------|--------|----------|---------|------------|
| EN | Code | Name | Source | Socket | Material | Color | Size |

ERSTE

| | | | | | | |
|-----------|------------------------------------|----------|-------|-----------------------------------|---------------|-----------|
| EL0081436 | Lustră SMOKY / Chandelier SMOKY | max. 60W | 2xE27 | Metal + Sticlă / Metal + Glass | Negru / Black | 595x270mm |
| EL0081437 | | | 3xE27 | | | 620x275mm |

i Alte produse din familiile SMOKY pot fi găsite la pagina 118.
Other products from the SMOKY family can be found on page 118.



IP20

ERSTE

| | | | | | | |
|----------|--|----------|-------|--|---------------|-----------|
| EL038446 | Lustră FASCINO / Chandelier FASCINO | max. 60W | 3xE14 | Metal + Cristale / Metal + Crystals | Alamă / Brass | 535X760mm |
|----------|--|----------|-------|--|---------------|-----------|

IP20



| RO | Cod | Denumire | Sursă | Dulie | Material | Culoare | Dimensiune |
|----|------|----------|--------|--------|----------|---------|------------|
| EN | Code | Name | Source | Socket | Material | Color | Size |

ERSTE

| | | | | | | |
|-----------|------------------------------------|----------|-------|-----------------------------------|--------------------------------|---------------|
| EL0023849 | Lustră TANIA / Chandelier TANIA | max. 60W | 2xE27 | Metal + Sticlă / Metal + Glass | Crom + Alb / Chrome + White | 400x200x250mm |
| EL0023850 | | | 3xE27 | | | 400x280mm |

i Alte produse din familia TANIA pot fi găsite la pagina 115.
Other products from the TANIA family can be found on page 115.



IP20

ERSTE

| | | | | | | |
|-----------|--|----------|-------|--|-----------------------------------|-----------|
| EL0038448 | Lustră PANDORA / Chandelier PANDORA | max. 60W | 3xE14 | Metal + Cristale / Metal + Crystals | Alb antichizat / Antique white | 550x485mm |
| EL0038449 | | | 5xE14 | | | 550x485mm |

i Alte produse din familia PANDORA poate fi găsită la pagina 113.
Other products from the PANDORA family can be found on page 113.

IP20



EL0023916



EL0023917



EL0023920



EL0023922



EL0023923

| Cod | Denumire | Sursă | Dulie | Material | Culoare | Dimensiune |
|-----------------|------------------------------------|----------|--------|----------|---------------------------|------------|
| Code | Name | Source | Socket | Material | Color | Size |
| EN ERSTE | | | | | | |
| EL0023916 | Lustră RODIN / Chandelier RODIN | max. 60W | 1xE27 | Metal | Crom / Chrome | 153x145mm |
| EL0023917 | | | | | Alb / White | |
| EL0023920 | | | 1xE14 | | Crom mat / Matt Chrome | 120x113mm |
| EL0023922 | | | | | Alb / White | 160x112mm |
| EL0023923 | | | | | Crom mat / Matt Chrome | |

RO

EN

IP20



EL0025972



EL0025973



EL0025978

| | | | | | | |
|--------------|------------------------------------|----------|-------|-------|---------------------------|-----------|
| ERSTE | | | | | | |
| EL0025972 | Lustră RODIN / Chandelier RODIN | max. 60W | 1xE14 | Metal | Alb / White | 120x113mm |
| EL0025973 | | | | | Crom mat / Matt Chrome | 153x145mm |
| EL0025978 | | | 3xE14 | | Crom / Chrome | 112x205mm |





LĂMPI INTERIOR DULIE

INDOOR LAMPS WITH SOCKET

RO

Lămpile cu dulie sunt soluții de iluminat versatile, potrivite atât pentru iluminatul ambiental, cât și pentru accente decorative, oferind un echilibru perfect între estetică și funcționalitate.

REPERE

- **Versatilitate** – adaptabile pentru diverse stiluri și utilizări;
- **Design variat** – disponibile în modele moderne și clasice;
- **Ușor de utilizat** – compatibile cu multiple tipuri de becuri.

EN

Lamps with sockets are versatile lighting solutions suitable for ambient and accent lighting, offering a perfect balance between aesthetics and functionality.

FEATURES

- **Versatility** – adaptable to various styles and uses;
- **Varied designs** – available in both modern and classic styles;
- **Easy to use** – compatible with multiple types of bulbs.

IP20



| RO | Cod | Denumire | Sursă | Dulie | Material | Culoare | Dimensiune |
|----|------|----------|--------|--------|----------|---------|------------|
| EN | Code | Name | Source | Socket | Material | Color | Size |

ERSTE

| | | | | | | | |
|-----------|-------------------------|--|----------|-------|---------------------|---------------|-----------|
| EL0029491 | | | | | | Negru / Black | |
| EL0029490 | Veioză ESİK / Lamp ESİK | | max. 40W | 1xE14 | Ceramică / Ceramics | Alb / White | 180x220mm |
| EL0029492 | | | | | | Roșu / Red | |



IP20

ERSTE

| | | | | | | | |
|-----------|-----------------------------|--|----------|-------|--|-----------------|-----------|
| EL0040206 | | | | | | Nuc / Walnut | |
| EL0040204 | Veioză BENDIS / Lamp BENDIS | | max. 40W | 1xE14 | Lemn și material textil alb / Wood and white textile | Wenge | 100x170mm |
| EL0040205 | | | | | | Antic / Antique | |



Alte produse din familia BENDIS pot fi găsite la paginile 109, 112, 134.

Other products from the BENDIS family can be found on pages 109, 112, 134.



LĂMPI DE BIROU DULIE

DESK LAMPS WITH SOCKET

RO

Lămpile de birou cu dulie sunt ideale pentru iluminarea optimă a spațiilor de lucru sau studiu, oferind confort vizual și un design ergonomic.

REPERE

- **Iluminare direcționată** – perfectă pentru citit și activități de precizie;
- **Reglabilitate** – ajustarea unghiului și intensității luminii;
- **Design ergonomic** – compacte și ușor de integrat în orice decor.

EN

Desk lamps with sockets are ideal for optimal lighting in work or study spaces, providing visual comfort and an ergonomic design.

FEATURES

- **Focused lighting** – perfect for reading and precision tasks;
- **Adjustability** – allows adjustment of the light angle and intensity;
- **Ergonomic design** – compact and easy to integrate into any décor.

IP20



| RO | Cod | Denumire | Sursă | Dulie | Material | Culoare | Dimensiune |
|----|------|----------|--------|--------|----------|---------|------------|
| EN | Code | Name | Source | Socket | Material | Color | Size |

ERSTE

| | | | | | | | |
|-----------|---------------------------------------|--|----------|-------|-----------------|-----------------|-----------|
| EL0021295 | | | | | | Alb / White | |
| EL0021296 | | | | | | Negru / Black | |
| EL0021297 | Lampă birou CLASIC / Desk lamp CLASIC | | max. 60W | 1xE27 | Metal + Plastic | Albastru / Blue | 330x143mm |
| EL0021298 | | | | | | Verde / Green | |
| EL0024870 | | | | | | Roșu / Red | |

IP20



ERSTE

| | | | | | | | |
|-----------|-----------------------------------|--|----------|-------|-----------------|-----------------|-----------|
| EL0021290 | | | | | | Alb / White | |
| EL0021291 | | | | | | Negru / Black | |
| EL0021292 | Lampă birou CLIP / Desk lamp CLIP | | max. 60W | 1xE27 | Metal + Plastic | Albastru / Blue | 265x120mm |
| EL0021293 | | | | | | Verde / Green | |
| EL0021294 | | | | | | Roșu / Red | |

CORPURI DE ILUMINAT DECORATIVE
SURSE
SMART HOME
APARATAJ
CONECTICĂ
PROTECȚII
CORPURI DE ILUMINAT TEHNICE
TRASEE
CABLURI

DECORATIVE LIGHTING FIXTURES
SOURCES
SMART HOME
SWITCHES AND SOCKETS
CONNECTORS
POWER AUTOMATION
TECHNICAL LIGHTNING FIXTURES
CABLE MANAGEMENT SYSTEMS
CABLES



IP20

| RO | Cod | Denumire | Sursă | Dulie | Material | Culoare | Dimensiune |
|----|------|----------|--------|--------|----------|---------|------------|
| EN | Code | Name | Source | Socket | Material | Color | Size |

ERSTE

| | | | | | | |
|-----------|-------------------------------------|----------|-------|-------|-----------------|-----------|
| EL0032131 | Lampă birou KLARA / Desk lamp KLARA | max. 40W | 1xE27 | Metal | Alb / White | 310x185mm |
| EL0032132 | | | | | Negru / Black | |
| EL0032133 | | | | | Albastru / Blue | |
| EL0032134 | | | | | Roșu / Red | |
| EL0033134 | | | | | Verde / Green | |



IP20

ERSTE

| | | | | | | |
|-----------|-----------------------------------|----------|-------|-------|---------------|-----------|
| EL0032128 | Lampă birou DESK / Desk lamp DESK | max. 60W | 1xE27 | Metal | Alb / White | 310x185mm |
| EL0032129 | | | | | Negru / Black | |



IP20



ACCESORII INTERIOR DULIE INDOOR SOCKET ACCESSORIES

RO

Accesoriile sunt componente esențiale care asigură instalarea facilă și utilizarea sigură a surselor de lumină, contribuind la compatibilitatea și durabilitatea sistemului de iluminat.

REPERE

- **Compatibilitate extinsă** – potrivite pentru diverse tipuri de becuri și corpuri de iluminat;
- **Montaj simplu** – instalare rapidă și utilizare intuitivă;
- **Materiale rezistente** – siguranță și durabilitate pe termen lung.

EN

Accessories are essential components that ensure easy installation and safe use of light sources, enhancing the compatibility and durability of the lighting system.

FEATURES

- **Extended compatibility** – suitable for various types of bulbs and lighting fixtures;
- **Easy installation** – quick setup and intuitive use;
- **Durable materials** – ensures long-term safety and reliability.



EL0002110



EL0004910



EL0004913



EL0005144



EL0005153



EL0005278



EL0014053



EL0024181



EL0024182

| RO | Cod | Denumire | Dulie | Material | Culoare | Dimensiune |
|----|------|----------|--------|----------|---------|------------|
| EN | Code | Name | Socket | Material | Color | Size |

ERSTE

| | | | | | | |
|-----------|--|------|---------------------|-------------|---|------|
| EL0002110 | Dulie ceramică E27 clemă / E27 ceramic light holder clamp | E27 | Ceramică / Ceramics | Alb / White | - | |
| EL0004910 | Dulie ceramică E27 / E27 ceramic light holder | E27 | | | | |
| EL0004913 | Dulie ceramică E14 / E14 ceramic light holder | E14 | | | | |
| EL0005144 | Dulie ceramică E14 clemă / E14 ceramic light holder clamp | E14 | | | | |
| EL0005153 | Dulie ceramică E40 / E40 ceramic light holder | E40 | | | | |
| EL0005278 | Dulie ceramică GU10 / GU10 ceramic light holder | GU10 | | | | |
| EL0014053 | Dulie ceramică E27 cu fustă / E27 ceramic light holder skirt | E27 | | | | |
| EL0024181 | Dulie ceramică G4 10cm / G4 ceramic light holder 10cm | G4 | | | | 10cm |
| EL0024182 | Dulie ceramică G4 15cm / G4 ceramic light holder 15cm | G4 | | | | 15cm |

IP20



EL0024395



EL0024396



EL0024397



EL0026585



EL0060805



EL0060806



EL0020884

| RO | Cod | Denumire | Dulie | Material | Culoare |
|----|------|----------|--------|----------|---------|
| EN | Code | Name | Socket | Material | Color |

ERSTE

| | | | | |
|-----------|---|-----|----------------------|---------------|
| EL0024395 | Dulie bachelită E27 / E27 bachelite light holder | E27 | Bachelită / Bakelite | Negru / Black |
| EL0024396 | Dulie bachelită E14 / E14 bachelite light holder | E14 | | |
| EL0024397 | Dulie bachelită E14 cu fustă / E14 bachelite light holder skirted | E14 | | |
| EL0026585 | Dulie bachelită E27 cu fustă / E27 bachelite light holder skirted | E27 | Ceramică / Ceramic | Alb / White |
| EL0060805 | Aplică ceramică dreaptă / Straight ceramic wall lamp | E27 | | |
| EL0060806 | Aplică ceramică oblică / Oblique ceramic wall lamp | E27 | | |

NOVELITE

| | | | | |
|-----------|--|-----|---|---------------|
| EL0020884 | Dulie bachelita + ceramică E27 / E27 Bakelite socket + ceramic | E27 | Bachelita + ceramică / Bakelite + ceramic | Negru / Black |
|-----------|--|-----|---|---------------|

IP20



EL0047410



EL0047411



EL0047409



EL0047408



EL0047407



| RO | Cod | Denumire | Culoare |
|----|------|----------|---------|
| EN | Code | Name | Color |

NOVELITE

| | | |
|-----------|---|-------------|
| EL0047410 | Adaptor dulie de la GU10 la E14 / Adapter socket from GU10 to E14 | Alb / White |
| EL0047411 | Adaptor dulie de la GU10 la E27 / Adapter socket from GU10 to E27 | |
| EL0047409 | Adaptor dulie de la E14 la E27 / Adapter socket from E14 to E27 | |
| EL0047408 | Adaptor dulie de la E27 la E14 / Adapter socket from E27 to E14 | |
| EL0047407 | Adaptor dulie de la E40 la E27 / Adapter socket from E40 to E27 | |



EL0042530



EL0042531

| RO | Cod | Denumire | Putere consumată | Dulie | Material | Culoare | Dimensiune |
|--------------|------|--|------------------|--------|--|---------------|--------------|
| EN | Code | Name | Power | Socket | Material | Color | Size |
| ERSTE | | | | | | | |
| EL0042530 | | Plafonieră SERES / Ceiling lamp SERES | max. 18W | 1xE27 | Aluminiu + Plastic / Aluminum + Plastic | Negru / Black | 200x290x90mm |
| EL0042531 | | | | | | | |

PLAFONIERE EXTERIOR DULIE

OUTDOOR CEILING LIGHTS WITH SOCKET

RO

Plafonierele cu dulie sunt soluții eficiente pentru iluminarea generală a spațiilor exterioare, oferind un design discret și o lumină uniformă, adaptabilă în funcție de becul utilizat.

REPERE

- **Distribuție uniformă** – iluminare echilibrată pentru terase, balcoane sau foișoare;
- **Economie de spațiu** – montaj direct pe suprafețe exterioare;
- **Durabilitate** – rezistente la umiditate și temperaturi variate.

EN

Ceiling lights with socket are an efficient solution for general lighting in covered outdoor spaces, offering a discreet design and uniform light adaptable to the bulb used.

FEATURES

- **Uniform distribution** – balanced lighting for terraces, balconies, or gazebos;
- **Space-saving** – mounted directly on outdoor surfaces;
- **Durability** – resistant to humidity and varying temperatures.

IP44



| RO | Cod | Denumire | Putere consumată | Dulie | Material | Culoare | Dimensiune |
|----|------|----------|------------------|--------|----------|---------|------------|
| EN | Code | Name | Power | Socket | Material | Color | Size |

ERSTE

| | | | | | | |
|-----------|-------------------------------------|----------|-------|--------------------------------------|---------------------------|-----------|
| EL0024855 | Aplică AMAZON / Wall lamp AMAZON | max. 11W | 1xE27 | Oțel inoxidabil / Stainless steel | Crom mat / Matt chrome | 135x205mm |
|-----------|-------------------------------------|----------|-------|--------------------------------------|---------------------------|-----------|

IP44

**ERSTE**

| | | | | | | |
|-----------|-------------------------------------|----------|-------|--------------------------------------|------------------|-----------|
| EL0032301 | Aplică ANDRES / Wall lamp ANDRES | max. 60W | 1xE27 | Oțel inoxidabil / Stainless steel | Crom / Chrome | 180x325mm |
|-----------|-------------------------------------|----------|-------|--------------------------------------|------------------|-----------|

APLICE EXTERIOR DULIE

OUTDOOR WALL LIGHTS WITH SOCKET

RO

Aplicele cu dulie sunt o soluție elegantă și practică pentru iluminatul ambiental al teraselor, fațadelor sau grădinilor, oferind un efect decorativ plăcut și posibilitatea de a ajusta lumina în funcție de preferințe.

REPERE

- **Iluminare direcționată** – oferă lumină focalizată sau difuză, în funcție de model;
- **Rezistență sporită** – construite din materiale rezistente la condițiile exterioare;
- **Instalare simplă** – montaj facil pe perete pentru un efect discret și elegant.

EN

Wall lights with socket are an elegant and practical solution for ambient lighting on terraces, facades or gardens, providing a pleasant decorative effect and the ability to adjust the lighting according to preferences.

FEATURES

- **Directional lighting** – offers focused or diffused light, depending on the model;
- **Increased durability** – made from materials resistant to outdoor conditions;
- **Easy installation** – simple wall mounting for a discreet and elegant effect.

CORPURI DE ILUMINAT DECORATIVE
SURSE
SMART HOME
APARATAJ
CONECTICĂ
PROTECȚII
CORPURI DE ILUMINAT TEHNICE
TRASEE
CABLURI

DECORATIVE LIGHTING FIXTURES
SOURCES
SMART HOME
SWITCHES AND SOCKETS
CONNECTORS
POWER AUTOMATION
TECHNICAL LIGHTNING FIXTURES
CABLE MANAGEMENT SYSTEMS
CABLES



| RO | Cod | Denumire | Putere consumată | Dulie | Material | Culoare | Dimensiune |
|----|------|----------|------------------|--------|----------|---------|------------|
| EN | Code | Name | Power | Socket | Material | Color | Size |

ERSTE

| | | | | | | | |
|-----------|-----------------------------------|----------|--------|---|---------------|----------|-----------|
| EL0033130 | Aplică ANTAL / Wall lamp ANTAL | max. 35W | 2xGU10 | Oțel inoxidabil / Stainless steel | Crom / Chrome | 90x158mm | |
| EL0073410 | | | | Cupru / Copper | | | |
| EL0042528 | | | | Antracit / Anthracite | | | |
| EL0042539 | | | | Oțel inoxidabil + Sticlă / Stainless steel + Glass | Crom / Chrome | | 120x215mm |
| EL0042540 | | | | Cupru / Copper | | | |
| EL0042541 | | | | Antracit / Anthracite | | | |



| RO | Cod | Denumire | Putere consumată | Dulie | Material | Culoare | Dimensiune |
|----|------|----------|------------------|--------|----------|---------|------------|
| EN | Code | Name | Power | Socket | Material | Color | Size |

ERSTE

| | | | | | | |
|-----------|-----------------------------------|----------|-------|-----------------|-----------------|---------------|
| EL0024559 | Aplică ANTIC / Wall lamp ANTIC | max. 60W | 1xE27 | Metal + Plastic | Antic / Antique | 230x190x370mm |
|-----------|-----------------------------------|----------|-------|-----------------|-----------------|---------------|



ERSTE

| | | | | | | |
|-----------|---------------------------------|----------|-------|--|--------------------------------|-----------|
| EL0021225 | Aplică ARES / Wall lamp ARES | max. 60W | 1xE27 | Oțel inoxidabil + Plastic / Stainless steel + Plastic | Crom + Alb / Chrome + White | 330x125mm |
| EL0032177 | | | | | | |



Alte produse din familia ARES pot fi găsite la pagina 171.
Other products from the ARES family can be found on page 171.



ERSTE

| | | | | | | |
|-----------|-------------------------------------|----------|-------|-----------------------------------|----------------|-----------|
| EL0028292 | Aplică CASIAN / Wall lamp CASIAN | max. 40W | 1xE27 | Metal + Sticlă / Metal + Glass | Cupru / Copper | 255x235mm |
|-----------|-------------------------------------|----------|-------|-----------------------------------|----------------|-----------|

IP44



| RO | Cod | Denumire | Putere consumată | Dulie | Material | Culoare | Dimensiune |
|----|------|----------|------------------|--------|----------|---------|------------|
| EN | Code | Name | Power | Socket | Material | Color | Size |

ERSTE

| | | | | | | |
|-----------|-------------------------------------|----------|-------|-----------------|-----------------|-----------|
| EL0026320 | Aplică CORINT / CORINT Wall lamp | max. 60W | 1xE27 | Metal + Plastic | Negru / Black | 190x375mm |
| EL0026321 | | | 1xE27 | | Antic / Antique | |

IP44



| RO | Cod | Denumire | Putere consumată | Dulie | Material | Culoare | Dimensiune |
|----|------|----------|------------------|--------|----------|---------|------------|
| EN | Code | Name | Power | Socket | Material | Color | Size |

ERSTE

| | | | | | | |
|-----------|-----------------------------------|----------|-------|---------|---------------|-----------|
| EL0041683 | Aplică FAUST / Wall lamp FAUST | max. 60W | 1xE27 | Plastic | Negru / Black | 145x198mm |
|-----------|-----------------------------------|----------|-------|---------|---------------|-----------|

IP44



ERSTE

| | | | | | | |
|-----------|---------------------------------|---------|-------|---------|--|---------------|
| EL0024383 | Aplică LUCA / Wall lamp LUCA | max.40W | 1xE27 | Plastic | Negru + Transparent / Black + Transparent | 200x260x255mm |
| EL0024384 | | | | | Negru + Alb / Black + White | |
| EL0024385 | | | | | Negru + fumuriu / Black + Smoky | |



Alte produse din familia LUCA pot fi găsite la pagina 167, 172.
Other products from the LUCA family can be found on page 167, 172.



IP44



ERSTE

| | | | | | | |
|-----------|-------------------------------------|----------|-------|-----------------|-----------------|-----------|
| EL0026330 | Aplică CORONA / Wall lamp CORONA | max. 60W | 1xE27 | Metal + Plastic | Negru / Black | 190x375mm |
| EL0026331 | | | | | Antic / Antique | |
| EL0035763 | | | | | | |
| EL0035764 | | | | | Negru / Black | |



Alte produse din familiile CORINT și CORONA pot fi găsite la paginile 163 și 171.
Other products from the CORINT and CORONA families can be found on pages 163 and 171.

IP44



| RO | Cod | Denumire | Putere consumată | Dulie | Material | Culoare | Dimensiune |
|----|------|----------|------------------|--------|----------|---------|------------|
| EN | Code | Name | Power | Socket | Material | Color | Size |

ERSTE

| | | | | | | |
|-----------|---|----------|-------|---------|---------------|-----------|
| EL0041680 | Aplică MEPHISTO / Wall lamp MEPHISTO | max. 60W | 1xE27 | Plastic | Negru / Black | 360X76mm |
| EL0041681 | | | | | | 145x198mm |



IP44

ERSTE

| | | | | | | |
|-----------|-----------------------------------|----------|--------|---|---------------|-------------|
| EL0078017 | Aplică SCOPE / Wall lamp SCOPE | max. 35W | 2xGU10 | Aluminiu + Sticlă / Aluminum + Glass | Negru / Black | 68x92x150mm |
|-----------|-----------------------------------|----------|--------|---|---------------|-------------|



IP44

ERSTE

| | | | | | | |
|-----------|-------------------------------------|----------|-------|----------------------------------|---------------|--------------|
| EL0078032 | Aplică SEVILA / Wall lamp SEVILA | max. 40W | 1xE27 | Aluminiu + PS / Aluminum + PS | Negru / Black | 150x90x200mm |
|-----------|-------------------------------------|----------|-------|----------------------------------|---------------|--------------|

i Alte produse din familia SEVILA pot fi găsite la pagina 172.
Other products from the SEVILA and family can be found on page 172.

IP44



| RO | Cod | Denumire | Putere consumată | Dulie | Material | Culoare | Dimensiune |
|----|------|----------|------------------|--------|----------|---------|------------|
| EN | Code | Name | Power | Socket | Material | Color | Size |

ERSTE

| | | | | | | |
|-----------|-----------------------------------|----------|-------|--|-------------------------------|---------------|
| EL0042533 | Aplică SOREY / Wall lamp SOREY | max. 60W | 1xE27 | Aluminiu + Plastic / Aluminum + Plastic | Negru / Black | 120x135x249mm |
| EL0042534 | | | | | Maro antic / Antique brown | 120x135x249mm |



IP44

ERSTE

| | | | | | | |
|-----------|-------------------------------------|----------|-------|----|--------------------------------|-------------|
| EL0078028 | Aplică FOLINA / Wall lamp FOLINA | max. 25W | 1xE27 | PP | Crom + Alb / Chrome + White | 311x90x97mm |
|-----------|-------------------------------------|----------|-------|----|--------------------------------|-------------|

IP44



PENDULE EXTERIOR DULIE

OUTDOOR PENDANTS WITH SOCKET

RO

Pendulele cu dulie sunt corpuri de iluminat ideale pentru spațiile exterioare acoperite, oferind un echilibru perfect între estetică și funcționalitate, cu posibilitatea de personalizare prin alegerea becului potrivit.

REPERE

- **Design rafinat** – disponibile în multiple stiluri și finisaje rezistente la exterior;
- **Iluminare focalizată** – perfecte pentru terase, pergolas sau foșoare;
- **Versatilitate** – compatibile cu o varietate de becuri pentru efecte luminoase diverse.

EN

Pendant lights with socket are ideal for covered outdoor spaces, offering a perfect balance between aesthetics and functionality, with the possibility of customization through the selection of a suitable bulb.

FEATURES

- **Refined design** – available in multiple styles and weather-resistant finishes;
- **Focused lighting** – perfect for terraces, pergolas or gazebos;
- **Versatility** – compatible with various types of bulbs for different lighting effects.



| RO | Cod | Denumire | Putere consumată | Dulie | Material | Culoare | Dimensiune |
|--------------|-----------------------------------|----------|------------------|-----------------|-----------------|-----------|------------|
| EN | Code | Name | Power | Socket | Material | Color | Size |
| ERSTE | | | | | | | |
| EL0026325 | Pendul CORINT / Pendant CORINT | max. 60W | 1xE27 | Metal + Plastic | Antic / Antique | 165x800mm | |
| EL0033131 | | | | | Negru / Black | | |

IP44



| Cod | Denumire | Putere consumată | Dulie | Material | Culoare | Dimensiune |
|--------------|-----------------------------------|------------------|--------|-----------------|-----------------|------------|
| Code | Name | Power | Socket | Material | Color | Size |
| ERSTE | | | | | | |
| EL0026333 | Pendul CORONA / Pendant CORONA | max. 60W | 1xE27 | Metal + Plastic | Antic / Antique | 165x800mm |



Alte produse din familiile CORINT și CORONA pot fi găsite la paginile 158 și 171.

Other products from the CORINT and CORONA families can be found on pages 158 and 171.

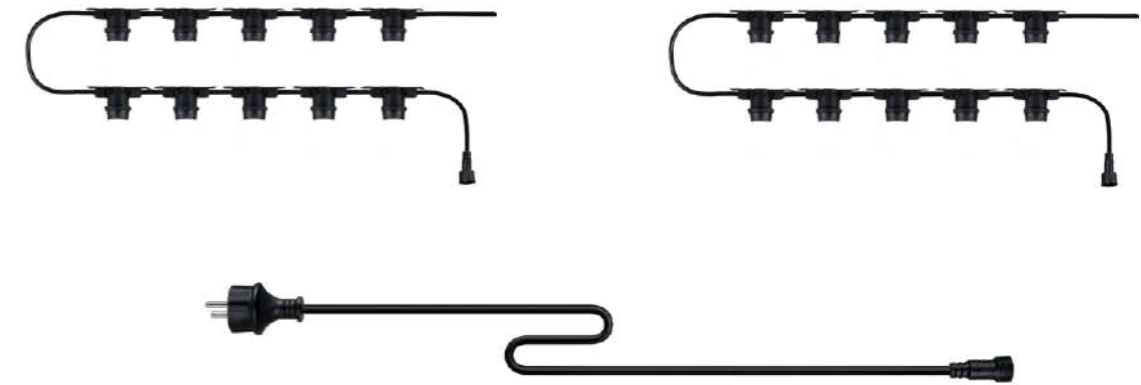

| RO | Cod | Denumire | Putere consumată | Dulie | Material | Culoare | Dimensiune |
|--------------|--------------------------------------|-----------|------------------|---------|---------------|---------|------------|
| EN | Code | Name | Power | Socket | Material | Color | Size |
| ERSTE | | | | | | | |
| EL0058241 | Ghirlandă / String Light | 750W | 10xE27 | Plastic | Negru / Black | 4500mm | |
| EL0058295 | | 750W | 10xE14 | | | 4500mm | |
| EL0058238 | Cablu ghirlandă / String Light Cable | max. 750W | - | | | 5000mm | |

GHIRLANDĂ EXTERIOR DULIE

OUTDOOR STRING LIGHT WITH SOCKET

RO

Ghirlandele luminoase cu dulie sunt perfecte pentru a crea o atmosferă caldă și primitoare în grădini, terase sau foisoare, permițând flexibilitate în configurarea iluminatului prin alegerea sursei de lumină potrivite.

REPERE

- **Efect decorativ** – ideal pentru iluminarea ambientală a evenimentelor sau spațiilor exterioare;
- **Flexibilitate** – rezistente la utilizare în exterior și ușor de integrat în diverse amenajări;
- **Personalizare** – compatibile cu diferite tipuri de becuri pentru efecte luminoase variate.

EN

String lights with socket are perfect for creating a warm and inviting atmosphere in gardens, terraces or gazebos, allowing flexibility in configuring lighting by choosing the appropriate light source.

FEATURES

- **Decorative effect** – ideal for ambient lighting of events or outdoor spaces.
- **Flexibility** – resistant for outdoor use and easy to integrate into various arrangements.
- **Customization** – compatible with different types of bulbs for varied lighting effects.





GLOB EXTERIOR DULIE

OUTDOOR GLOBE WITH SOCKET

RO

Globurile luminoase cu dulie sunt o alegere modernă și elegantă pentru grădini, terase sau alei, oferind o iluminare de efect, adaptabilă în funcție de tipul de sursă de lumină utilizată.

REPERE

- **Design contemporan** – ideale pentru diverse stiluri de amenajare exterioară;
- **Versatilitate** – pot fi utilizate individual sau în grupuri decorative;
- **Durabilitate** – realizate din materiale rezistente la condițiile de mediu.

EN

Globe lights with socket are a modern and elegant choice for gardens, terraces or pathways, offering an impressive lighting effect adaptable to the type of light source used.

FEATURES

- **Contemporary design** – ideal for various outdoor decor styles;
- **Versatility** – can be used individually or in decorative clusters;
- **Durability** – made from materials resistant to environmental conditions.

IP44



| RO | Cod | Denumire | Putere consumată | Dulie | Material | Culoare | Dimensiune |
|----|------|----------|------------------|--------|----------|---------|------------|
| EN | Code | Name | Power | Socket | Material | Color | Size |

ERSTE

| | | | | | | | |
|-----------|------------------------|---------|-------|---------|---------------------------------|---|-----------|
| EL0024389 | | | | | | Negru + Transparent / Black + Transparent | 200x260mm |
| EL0024391 | Glob LUCA / LUCA Globe | max.40W | 1xE27 | Plastic | Negru + fumuriu / Black + smoky | | |
| EL0033129 | | | | | Alb + Negru / White + Black | | |



Alte produse din familia LUCA pot fi găsite la paginile 159 și 172.
Other products from the LUCA family can be found on pages 159 and 172.

IP44



ERSTE

| | | | | | | |
|-----------|------------------------------|---------|-------|----------|-----------------------------|-------|
| EL0078029 | Glob MONOLIT / MONOLIT Globe | max.40W | 1xE27 | ABS + PS | Alb + Negru / White + Black | 300mm |
| EL0078030 | | | | | | 400mm |



EL0026003



EL0026005

| RO | Cod | Denumire | Putere consumată | Dulie | Material | Culoare | Dimensiune |
|--------------|-----------|--------------------------------|------------------|--------|---------------------|---------------|------------|
| EN | Code | Name | Power | Socket | Material | Color | Size |
| ERSTE | | | | | | | |
| | EL0026003 | Spot PHILIP / PHILIP Spotlight | max. 35W | 1xGU10 | Aluminiu / Aluminum | Negru / Black | 97x345mm |
| | EL0026005 | | | | | | 97x315mm |

SPOTURI EXTERIOR DULIE

OUTDOOR SPOTLIGHT WITH SOCKET

RO

Spoturile cu dulie sunt o opțiune ideală pentru iluminatul direcționat al grădinilor, fațadelor sau aleilor, permițând controlul asupra luminozității prin selecția sursei de lumină potrivite.

REPERE

- **Precizie** – ideale pentru evidențierea anumitor zone sau elemente arhitecturale;
- **Flexibilitate** – disponibile în variante fixe sau reglabile;
- **Eficiență** – asigură un consum redus de energie și o iluminare adaptabilă.

EN

Spotlights with socket are an ideal option for directional lighting in gardens, facades or pathways, allowing control over brightness by selecting the appropriate light source.

FEATURES

- **Precision** – ideal for highlighting specific areas or architectural elements;
- **Flexibility** – available in fixed or adjustable versions;
- **Efficiency** – ensures low energy consumption and adaptable lighting.



STÂLP EXTERIOR DULIE

OUTDOOR LIGHT POLE WITH SOCKET

RO

Stâlpii decorativi cu dulie sunt soluții ideale pentru iluminarea exterioară, oferind siguranță și estetică aleilor, grădinilor sau curților.

REPERE

- **Iluminare eficientă** – perfecte pentru marcarea căilor de acces și a spațiilor exterioare;
- **Design elegant** – disponibile în diferite stiluri pentru integrare armonioasă;
- **Rezistență la intemperii** – fabricate din materiale durabile pentru utilizare îndelungată.

EN

Decorative light poles with socket are ideal solutions for exterior lighting, providing safety and aesthetics for pathways, gardens or yards.

FEATURES

- **Efficient lighting** – perfect for marking access paths and outdoor spaces;
- **Elegant design** – available in different styles for seamless integration;
- **Weather resistance** – made from durable materials for long-term use.

IP44



| RO | Cod | Denumire | Putere consumată | Dulie | Material | Culoare | Dimensiune |
|----|------|----------|------------------|--------|----------|---------|------------|
| EN | Code | Name | Power | Socket | Material | Color | Size |

ERSTE

| | | | | | | | |
|-----------|---------------------------------|--|----------|-------|--|--------------------------------|-----------|
| EL0032297 | | | | | | | 76x430mm |
| EL0032298 | Stâlp ARES / Light pole ARES | | max. 60W | 1xE27 | Oțel inoxidabil + Plastic / Stainless steel + Plastic | Crom + Alb / Chrome + White | 76x640mm |
| EL0032299 | | | | | | | 76x1100mm |



Alte produse din familia ARES pot fi găsite la pagina 157.

Other products from the ARES family can be found on page 157.



IP44

ERSTE

| | | | | | | | |
|-----------|-------------------------------------|--|----------|-------|-----------------|-----------------|------------|
| EL0026336 | Stâlp CORONA / Light pole CORONA | | max. 60W | 1xE27 | Metal + Plastic | Negru / Black | 165x1050mm |
| EL0026337 | | | | | | Antic / Antique | 165x1050mm |



Alte produse din familiile CORINT și CORONA pot fi găsite la paginile 158, 163.

Other products from the CORINT and CORONA families can be found on pages 158, 163.

IP44



| RO | Cod | Denumire | Putere consumată | Dulie | Material | Culoare | Dimensiune |
|----|------|----------|------------------|--------|----------|---------|------------|
| EN | Code | Name | Power | Socket | Material | Color | Size |

ERSTE

| | | | | | | |
|-----------|---------------------------------|----------|-------|---------|--|-----------|
| EL0024386 | Stâlp LUCA / Light pole LUCA | max. 40W | 1xE27 | Plastic | Negru + Transparent / Black + Transparent | 200x350mm |
| EL0024388 | | | | | Negru + Fumuriu / Black + smoky | |
| EL0024392 | | | | | Alb + Negru / White + Black | 170x700mm |
| EL0033128 | | | | | | 200x350mm |

i Alte produse din familia LUCA pot fi găsite la paginile 159, 167.
Other products from the LUCA family can be found on pages 159, 167.



IP44

ERSTE

| | | | | | | |
|-----------|-------------------------------------|----------|-------|-----------------------------------|---------------|--------------|
| EL0078033 | Stâlp SEVILA / Light pole SEVILA | max. 40W | 1xE27 | Aluminiu + PS / Aluminium + PS | Negru / Black | 90x130x500mm |
|-----------|-------------------------------------|----------|-------|-----------------------------------|---------------|--------------|

i Alte produse din familia SEVILA pot fi găsite la pagina 160.
Other products from the SEVILA and family can be found on page 160.



SURSE DE ILUMINAT

LIGHT SOURCES

| | |
|--------------------------------------|-----|
| Baghetă LED link - LED link lightbar | 176 |
| Bandă LED - LED strip | 180 |
| Bec LED - LED bulb | 186 |
| Tub LED - LED tube | 194 |
| Bec halogen - Halogen bulb | 196 |
| Bec incandescent - Incandescent bulb | 200 |



BAGHETĂ LED LINK LED LINK LIGHTBAR

RO

Baghetele LED reprezintă o soluție practică și estetică pentru iluminarea spațiilor interioare sau exterioare. Acestea asigură o lumină liniară, uniformă și pot fi integrate cu ușurință în diverse proiecte decorative sau funcționale.

REPERE

- **Luminozitate uniformă** - distribuție constantă a luminii pe toată lungimea;
- **Eficiență energetică** - consum redus de energie pentru performanțe excelente;
- **Instalare stabilă** - design rigid pentru montare rapidă și precisă.

EN

LED light bars are a practical and stylish solution for illuminating indoor or outdoor spaces. They provide linear, uniform light and can be easily integrated into various decorative or functional projects.

FEATURES

- **Uniform brightness** - consistent light distribution along the entire length;
- **Energy efficiency** - low energy consumption with excellent performance;
- **Stable installation** - rigid design for quick and precise mounting.

LED 230V IP20

| RO | Cod | Denumire | Putere consumată | Tensiune | Temperatura de culoare | Flux luminos | CRI | Unghi dispersie | Ore funcționare | Dimensiuni |
|----|------|----------|------------------|----------|------------------------|---------------|-----|-----------------|-----------------|------------|
| EN | Code | Name | Power | Voltage | Color temperature | Luminous flux | CRI | Beam angle | Operating hours | Size |

ERSTE - BAGHETE LED / LED LINK LIGHTBAR

| | | | | | | | | | |
|-----------|---------------------------------|-----|-----|-------|--------|----|------|---------|-------------|
| EL0042724 | Baghetă LED / LED Link lightbar | 5W | 24V | 6000K | 320lm | 80 | 100° | 50.000h | 300x18x8mm |
| EL0042725 | | 9W | | | 580lm | | | | 600x18x8mm |
| EL0042726 | | 14W | | | 950lm | | | | 900x18x8mm |
| EL0042727 | | 17W | | | 1050lm | | | | 1200x18x8mm |



Baghetă LED / LED link lightbar

| RO | Cod | Denumire | Putere consumată | Grad de protecție | Tensiune alimentare | Tensiune ieșire | Curent | Dimensiuni |
|----|------|----------|------------------|---------------------------|---------------------|-----------------|---------|--------------|
| EN | Code | Name | Power | Ingress protection rating | Supply voltage | Output voltage | Current | Size (LxWxh) |

ERSTE - DRIVER BAGHETE LED / DRIVER WITH CABLE

| | | | | | | | |
|-----------|-------------------------------------|-----|------|------|-----|------|-------------|
| EL0042743 | Driver cu cablu / Driver with cable | 20W | IP20 | 230V | 24V | 0.84 | 300x18x8mm |
| EL0042744 | | 40W | | | | 1.67 | 600x18x8mm |
| EL0042745 | | 60W | | | | 2.5 | 900x18x8mm |
| EL0042746 | | 80W | | | | 3.3 | 1200x18x8mm |



Driver cu cablu / Driver with cable

| RO | Cod | Denumire | Tensiune | Grad de protecție | Lungime | Lățime | Înălțime |
|----|------|----------|----------|---------------------------|---------|--------|----------|
| EN | Code | Name | Voltage | Ingress protection rating | Length | Width | Height |

ERSTE - ACCESORII BAGHETE LED / LED LINK LIGHTBAR ACCESSORIES

| | | | | | | | |
|-----------|---|-----|------|-------|--------|------|--|
| EL0042728 | Cablu de conexiune / Connection cable | 24V | IP20 | 500mm | - | - | |
| EL0042729 | Cablu de conexiune cu comutator touch / Connection cable with touch switch | | | | - | - | |
| EL0042730 | Cablu de conexiune cu comutator senzor / Connection cable with sensor switch | | | | - | - | |
| EL0042731 | Cablu de conexiune cu comutator dimmer / Connection cable with dimmer switch | | | | - | - | |
| EL0042732 | Cablu de extensie 0.5m / Extension cable 0.5m | | | - | - | | |
| EL0042735 | Conector îmbinare "L" stânga / Left „L” joint connector | | | 26mm | 26mm | 12mm | |
| EL0042736 | Conector îmbinare "L" dreapta / Right „L” joint connector | | | 26mm | 26mm | | |
| EL0042737 | Conector îmbinare "T" / „T” joint connector | | | 32mm | 32mm | | |
| EL0042738 | Conector îmbinare "+" / „+” joint connector | | | 32mm | 32mm | | |
| EL0042739 | Conector îmbinare colț "L" / Corner „L” joint connector | | | 16mm | 18mm | 16mm | |
| EL0042741 | Cleme fixare 90gr (set 2 buc.) / 90-degree fixing clips (set of 2 pieces) | - | - | 20mm | 19.5mm | 12mm | |
| EL0042742 | Conector de îmbinare / Joint connector | - | - | - | - | - | |



EL0042728

EL0042729

EL0042730

EL0042731



EL0042732

EL0042735, EL0042736

EL0042737

EL0042738



EL0042739

EL0042741

EL0042742





BANDĂ LED

LED STRIP

RO

Banda LED este o soluție modernă și eficientă pentru iluminat, ideală pentru a crea efecte decorative sau pentru a adăuga lumină suplimentară în spații diverse. Flexibilitatea acesteia permite instalarea ușoară în locuri greu accesibile sau pe suprafețe curbate, adaptându-se perfect nevoilor tale.

REPERE

- **Design flexibil** – se mulează ușor pe orice formă sau suprafață;
- **Eficiență energetică** – consum redus de energie, cu o luminozitate excelentă;
- **Versatilitate** – potrivită pentru iluminat ambiental, decorativ sau funcțional.

EN

LED strips offer a modern and efficient lighting solution, perfect for creating decorative effects or adding extra light to various spaces. Their flexibility allows for easy installation in hard-to-reach areas or on curved surfaces, adapting perfectly to your needs.

FEATURES

- **Flexible design** – easily molds to any shape or surface;
- **Energy efficiency** – low energy consumption with excellent brightness;
- **Versatility** – ideal for ambient, decorative, or functional lighting.



| RO | Cod | Denumire | Putere consumată | Temperatură de culoare | Flux luminos | Grad de protecție | Nr. LED/m | Tăiere | Tip LED | Dimensiuni |
|----|------|----------|------------------|------------------------|---------------|---------------------------|-----------------|---------|----------|------------|
| EN | Code | Name | Power | Color temperature | Luminous flux | Ingress protection rating | Number of LED/m | Cutting | LED Type | Size |

ERSTE - BANDĂ LED 12V / 12V LED STRIP

| | | | | | | | | | | | | | |
|-----------|-------------------------------|----------|---------|---------|------|---------|---------|------|--------------|---------------|------|--------------|---------------|
| EL0021077 | Banda LED 12V / LED Strip 12V | 4.8W/m | 2700K | 180lm/m | IP20 | 60buc/m | 50mm | 3528 | 5000x500x8mm | | | | |
| EL0021075 | | | 6400K | | | | | | | | | | |
| EL0021054 | | 2700K | 360lm/m | | | | | | | | | | |
| EL0048160 | | 4000K | | | | | | | | | | | |
| EL0021052 | | 6400K | | | | | | | | | | | |
| EL0020997 | | 2700K | 600lm/m | | | | | | | | | | |
| EL0048159 | | 4000K | | | | | | | | | | | |
| EL0020994 | | 14.4 W/m | 6400K | 60buc/m | | 50mm | 5050 | | | 5000x500x10mm | | | |
| EL0025949 | | RGB | | | | | | | | | | | |
| EL0030427 | | 4.8W/m | 2700K | 180lm/m | | IP65 | 60buc/m | | | 50mm | 3528 | 5000x500x8mm | |
| EL0030426 | | | 6400K | | | | | | | | | | |
| EL0030429 | | 2700K | 360lm/m | | | | | | | | | | |
| EL0048166 | | 4000K | | | | | | | | | | | |
| EL0030428 | | 6400K | | | | | | | | | | | |
| EL0030431 | | 2700K | 600lm/m | | | | | | | | | | |
| EL0048165 | | 4000K | | | | | | | | | | | |
| EL0030430 | | 14.4 W/m | 6400K | 60buc/m | | | 50mm | | | 5050 | | | 5000x500x10mm |
| EL0030432 | | RGB | | | | | | | | | | | |



Banda LED 12V / 12V LED strip

| RO | Cod | Denumire | Grad de protecție |
|----|------|----------|---------------------------|
| EN | Code | Name | Ingress protection rating |

ERSTE - CONECTORI BANDĂ LED 12V / 12V LED STRIP CONNECTORS

| | | |
|-----------|---|------|
| EL0021133 | Conectori banda LED 3528 - mono / LED strip connectors 3528 - mono | IP20 |
| EL0021137 | Conectori banda LED 3528 - mono cu fir / LED strip connectors 3528 - mono with wire | |
| EL0021135 | Conectori banda LED 5050 - mono / LED strip connectors 5050 - mono | |
| EL0021138 | Conectori banda LED 5050 - mono cu fir / LED strip connectors 5050 - mono with wire | |
| EL0021136 | Conectori banda LED 3528/5050 - RGB / LED strip connectors 3528/5050 - RGB | IP65 |
| EL0021139 | Conectori banda LED 3528/5050 - RGB cu fir T / LED strip connectors 3528/5050 - RGB with „T” wire | |
| EL0021140 | Conectori banda LED 3528/5050 - mono cu pini / LED strip connectors 3528/5050 - mono with pins | |
| EL0021142 | Conectori banda LED 3528/5050 - pini / LED strip connectors 3528/5050 - pins | |
| EL0079937 | Conectori banda LED 3528/5050 - pini alb / LED strip connectors 3528/5050 - white pins | IP20 |
| EL0031319 | Mufă conexiune banda LED mono - mama / LED strip mono connection socket - female | |
| EL0026000 | Mufă conexiune banda LED mono - tata / LED strip mono connection socket - male | |
| EL0026001 | Mufă conexiune rapidă banda LED - RGB / Quick connection socket for RGB LED strip | |

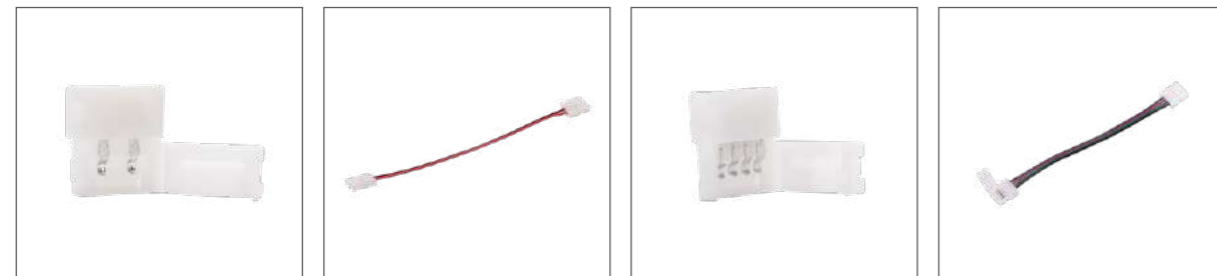

EL0021135 EL0021133 EL0021137 EL0021138 EL0021136 EL0021139

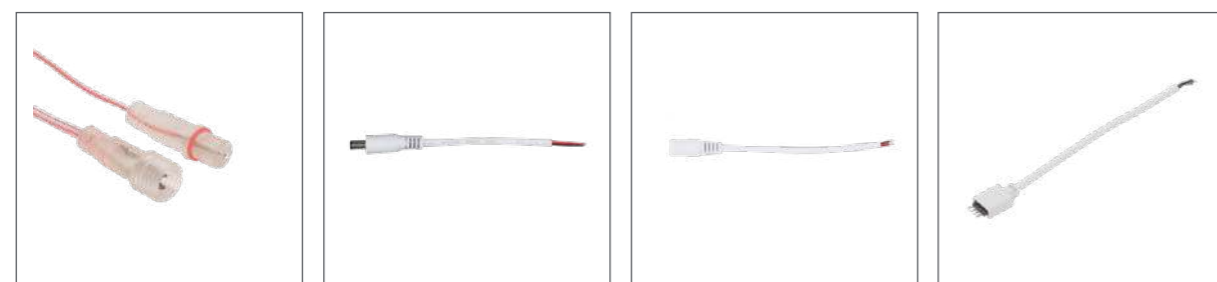

EL0021140 EL0026000 EL0031319 EL0026001

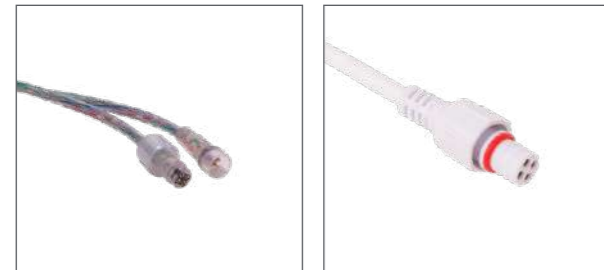

EL0021142 EL0079937

| RO | Cod | Denumire | Putere consumată | Tensiune | Tensiune alimentare iesire | Grad de protecție | Current | Lungime cablu | Temperatură mediu ambient | Dimensiuni |
|----|------|----------|------------------|----------|-----------------------------|---------------------------|---------|---------------|---------------------------|------------|
| EN | Code | Name | Power | Voltage | Voltage power supply output | Ingress protection rating | Current | Cable length | Ambient temperature | Size |

ERSTE - SURSE ALIMENTARE / CONTROLER / AMPLIFICATOR BANDA LED 12V / LED POWER SUPPLY / LED CONTROLLER/ RGB AMPLIFIER

| | | | | | | | | | |
|-----------|---|--|-------------|-------------|-------------|------------|-------------|-----------------|-------------|
| EL0030735 | Amplificator 144W RGB 12-24V / Amplifier 144W RGB 12-24V | max 144W - 12V/4A max 288W - 24V/4A | DC 12 - 24V | DC 12 - 24V | IP20 | 3x4A | - | -20°C+ +40°C | 100x65x25mm |
| EL0026856 | Controller wireless 288W RGB 230V / Controller wireless 288W RGB 230V | max 144W - 12V/4A - max 576W - 24V/8A | 230V | DC 12 - 24V | | 3x4A /3x8A | - | | 130x65x25mm |
| EL0021121 | Controller wireless 72W RGB 230V / Controller wireless 72W RGB 230V | 72W | | DC 12 - 24V | | 3x2A | - | - | 137x97x46mm |
| EL0031205 | Sursă alimentare / Power supply | 12W | | 12V | | IP20 | 1A | - | 30x70x40mm |
| EL0031204 | | 24W | | | 2A | | - | 28x108x43mm | |
| EL0031203 | | 30W | 2.5A | | - | | 28x108x34mm | | |
| EL0031202 | | 36W | 3A | | 1.5m | | - | 30x110x50mm | |
| EL0035630 | | 48W | 4A | | - | | - | | |
| EL0031201 | | 60W | 5A | | - | | - | 31x133x57mm | |
| EL0031200 | | 72W | 6A | | - | | - | 42x160x98mm | |
| EL0021114 | | 100W | 8.5A | | - | | - | 42x160x98mm | |
| EL0021115 | | 150W | 12.5A | | - | | - | 42x199x98mm | |
| EL0021116 | | 200W | 16.5A | | - | | - | 50x215x115mm | |
| EL0021117 | | 350W | 29A | | - | | - | 50x215x115mm | |
| EL0021118 | 100W | 8.5A | - | - | 42x160x98mm | | | | |
| EL0021119 | 150W | 12.5A | - | - | 42x199x98mm | | | | |



EL0030735 EL0026856 EL0021121 EL0031205 EL0031203 EL0031204 EL0035630 EL0031201 EL0031200

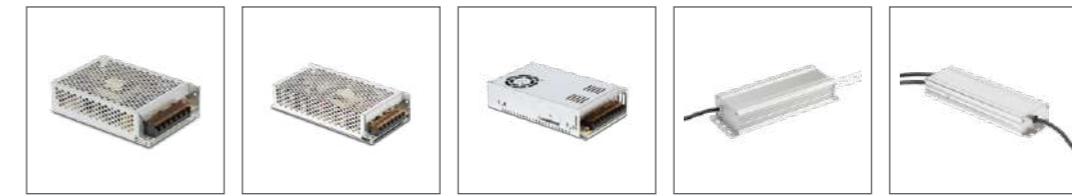

EL0021114 EL0021115 EL0021116 EL0021117 EL0021118 EL0021119

i Sursa de alimentare a banzii LED are IN 230V și OUT 12V
LED power supply: IN 230V and OUT 12V



| RO | Cod | Denumire | Putere consumată | Temperatură de culoare | Flux luminos | CRI | Nr. LED/m | Tăiere | Dimensiuni |
|----|------|----------|------------------|------------------------|---------------|-----|-----------------|---------|------------|
| EN | Code | Name | Power | Color temperature | Luminous flux | CRI | Number of LED/m | Cutting | Size |

ERSTE - BANDĂ LED 230V / LED STRIP 230V

| | | | | | | | | |
|-----------|---------------------------------|---------|-------------------------|---------|-----|---------|--------|--------------|
| EL0025984 | Bandă LED 230V / LED Strip 230V | 14.4W/m | 2700K | 600lm/m | >80 | 60buc/m | 1000mm | 50000x15x7mm |
| EL0048167 | | | 4000K | | | | | |
| EL0025985 | | | 6400K | | | | | |
| EL0025989 | | | Multicolor / Multicolor | - | | | | |
| EL0025986 | | | Albastru / Blue | - | | | | |
| EL0025988 | | | Roșu / Red | 600lm/m | | | | |
| EL0025987 | | | Verde / Green | | | | | |

| RO | Cod | Denumire | Lungime |
|----|------|----------|---------|
| EN | Code | Name | Length |

ERSTE - ACCESORII BANDĂ LED 230V / LED STRIP 230V ACCESSORIES

| | | |
|-----------|--|-------|
| EL0025990 | Cablu alimentare bandă LED RGB / Power cable LED strip RGB | 400mm |
| EL0025991 | Cablu alimentare bandă LED RGB / Power cable LED strip RGB | 200mm |
| EL0028071 | Clips montaj (5buc/set) / Mounting clips | - |
| EL0025992 | Set accesorii banda LED monocolor / LED strip connectors 5050 - mono with wire | - |
| EL0025993 | Set accesorii banda LED RGB / RGB LED strip accessories kit | - |

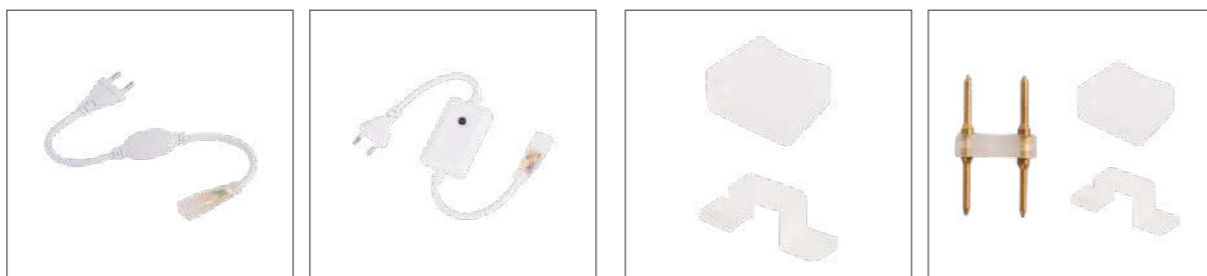

EL0025990

EL0025991

EL0028071

EL0025992

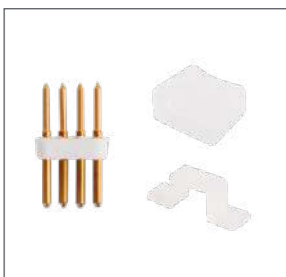

EL0025993

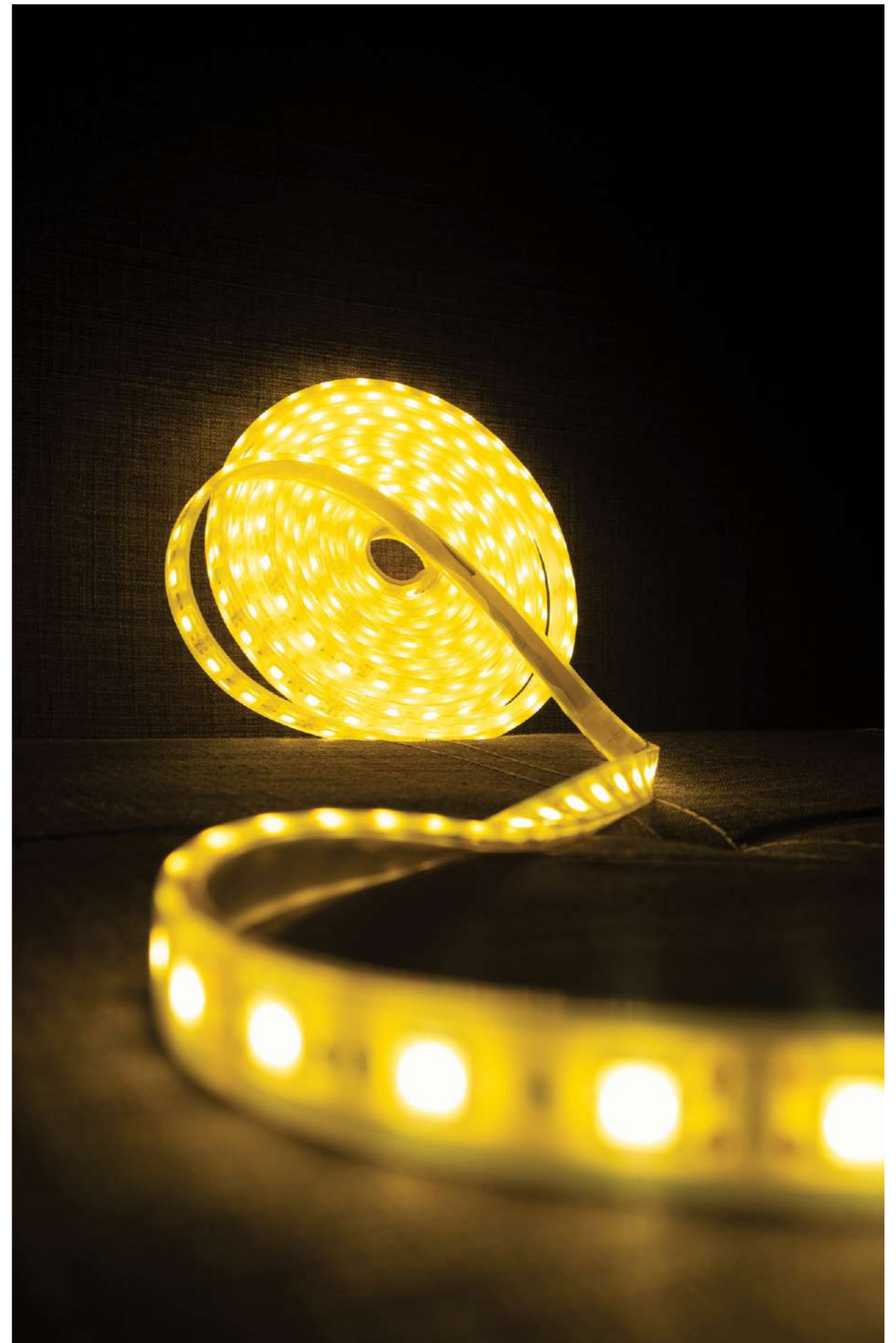



BEC LED LED BULB

RO

Becurile LED reprezintă o soluție modernă pentru iluminatul locuinței sau al spațiilor comerciale, oferind eficiență energetică, durată de viață extinsă și performanță superioară. Acestea emit o lumină clară și uniformă, fiind disponibile într-o varietate de forme, dimensiuni și diferite temperaturi de culoare pentru a se potrivi oricărui stil sau necesitate.

REPERE

- **Eficiență energetică** – consum redus de energie comparativ cu becurile tradiționale;
- **Durată de viață îndelungată** – funcționează de până la 25 de ori mai mult decât becurile convenționale;
- **Varietate de opțiuni** – disponibile în diverse culori și intensități luminoase.

EN

LED bulbs are a modern solution for home or commercial lighting, offering energy efficiency, extended lifespan, and superior performance. They emit clear and uniform light and come in a variety of shapes, sizes, and various color temperatures to suit any style or need.

FEATURES

- **Energy efficiency** – significantly lower energy consumption compared to traditional bulbs;
- **Long lifespan** – lasts up to 25 times longer than conventional bulbs;
- **Wide variety** – available in different colors and brightness levels.



| RO | Cod | Putere consumată | Temperatura de culoare | Flux luminos | Randament luminos | CRI | Unghi de distribuție luminoasă | Formă | Finisaj | Număr minim de cicluri comutare ON/OFF | Durată de viață | Dimensiuni | Clasă energetică |
|----|------|------------------|------------------------|---------------|---------------------|-----|--------------------------------|-------|---------|---|----------------------|------------|-------------------------|
| EN | Code | Power | Color temperature | Luminous flux | Luminous efficiency | CRI | Beam angle | Form | Finish | Minimum number of ON/OFF switching cycles | Nominal service life | Size | Energy efficiency class |

HOMELIGHT - BECURI LED / LED BULBS

| | | | | | | | | | | | | |
|-----------|-----|-------|--------|--------|-----|------|-----|-----|-------|--------|----------|---|
| EL0080984 | 8W | 6400K | 680lm | 85lm/W | >80 | 220° | A60 | Mat | 10000 | 15000h | 109x60mm | F |
| EL0084208 | 10W | | 850lm | | | | | | | | | |
| EL0084209 | 12W | | 1020lm | | | | | | | | | |
| EL0084210 | 14W | | 1190lm | | | | | | | | | |

| RO | Cod | Putere consumată | Temperatura de culoare | Flux luminos | Randament luminos | CRI | Unghi de distribuție luminoasă | Formă | Finisaj | Număr minim de cicluri comutare ON/OFF | Durată de viață | Dimensiuni | Clasă energetică |
|----|------|------------------|------------------------|---------------|---------------------|-----|--------------------------------|-------|---------|---|----------------------|------------|-------------------------|
| EN | Code | Power | Color temperature | Luminous flux | Luminous efficiency | CRI | Beam angle | Form | Finish | Minimum number of ON/OFF switching cycles | Nominal service life | Size | Energy efficiency class |

NOVELITE - BECURI LED / LED BULBS

| | | | | | | | | | | | | |
|-----------|-----|-------|--------|--------|-----|------|-----|-----|-------|--------|----------|---|
| EL0080992 | 7W | 3000K | 630lm | 90lm/W | >80 | 220° | A60 | Mat | 15000 | 20000h | 108x60mm | F |
| EL0080993 | | 6400K | | | | | | | | | | |
| EL0080994 | 9W | 3000K | 810lm | 90lm/W | >80 | 220° | A60 | Mat | 15000 | 20000h | 108x60mm | F |
| EL0080995 | | 6400K | | | | | | | | | | |
| EL0080996 | 12W | 3000K | 1080lm | 95lm/W | >80 | 220° | A60 | Mat | 15000 | 20000h | 116x60mm | F |
| EL0080997 | | 4000K | | | | | | | | | | |
| EL0080998 | 15W | 6400K | 1350lm | 95lm/W | >80 | 220° | A70 | Mat | 15000 | 20000h | 116x60mm | F |
| EL0080999 | | 3000K | | | | | | | | | | |
| EL0081000 | 18W | 3000K | 1710lm | 95lm/W | >80 | 220° | A70 | Mat | 15000 | 20000h | 119x60mm | F |
| EL0081001 | | 4000K | | | | | | | | | | |
| EL0081002 | 20W | 6400K | 1900lm | 95lm/W | >80 | 220° | A80 | Mat | 15000 | 20000h | 138x70mm | F |
| EL0081003 | | 3000K | | | | | | | | | | |



A60



A70



A80



| RO | Cod | Putere consumată | Dulie | Temperatură de culoare | Flux luminos | Randament luminos | CRI | Finisaj | Număr minim de cicluri comutare ON/OFF | Durată de viață nominală | Dimensiuni |
|----|------|------------------|-------|------------------------|---------------|---------------------|-----|---------|---|--------------------------|------------|
| EN | Code | Power | Base | Color temperature | Luminous flux | Luminous efficiency | CRI | Finish | Minimum number of ON/OFF switching cycles | Nominal service life | Size |

HOMELIGHT - BEC LED LUMÂNARE / LED CANDLE BULB

| | | | | | | | | | | |
|-----------|----|-----|-------|-------|--------|-----|-----|-------|--------|----------|
| EL0080985 | 5W | E14 | 6400K | 425lm | 85lm/W | >80 | Mat | 10000 | 15000h | 100x37mm |
| EL0080986 | 5W | E27 | 6400K | 425lm | 82lm/W | >80 | Mat | | | 99x37mm |

NOVELITE - BEC LED LUMÂNARE / LED CANDLE BULB

| | | | | | | | | | | |
|------------|----|-----|-------|-------|--------|-----|-----|-------|--------|----------|
| EL0081004 | 5W | E14 | 3000K | 450lm | 90lm/W | >80 | Mat | 15000 | 20000h | 100x37mm |
| EL0081005 | | | 6400K | | | | | | | 81x45mm |
| EL0084213 | 7W | E14 | 3000K | 630lm | 90lm/W | >80 | Mat | 15000 | 20000h | 107x37mm |
| EL0082113 | | | 6400K | | | | | | | 100x37mm |
| EL0081008* | 5W | E27 | 3000K | 450lm | 90lm/W | >80 | Mat | 15000 | 20000h | 125x37mm |
| EL0081006 | | | 6400K | | | | | | | 100x37mm |
| EL0081007 | 7W | E27 | 3000K | 630lm | 90lm/W | >80 | Mat | 15000 | 20000h | 107x37mm |
| EL0084217 | | | 6400K | | | | | | | 100x37mm |
| EL0084218 | 7W | E27 | 6400K | 630lm | 90lm/W | >80 | Mat | 15000 | 20000h | 107x37mm |

* Bec LED lumânare flacără / LED flame candle bulb



E14



E27



Lumânare flacără E14 / E14 Flame candle



| RO | Cod | Putere consumată | Dulie | Temperatură de culoare | Flux luminos | Randament luminos | CRI | Finisaj | Număr minim de cicluri comutare ON/OFF | Durată de viață nominală | Dimensiuni |
|----|------|------------------|-------|------------------------|---------------|---------------------|-----|---------|---|--------------------------|------------|
| EN | Code | Power | Base | Color temperature | Luminous flux | Luminous efficiency | CRI | Finish | Minimum number of ON/OFF switching cycles | Nominal service life | Size |

HOMELIGHT - BEC LED SFERIC / LED SPHERICAL BULB

| | | | | | | | | | | |
|-----------|----|-----|-------|-------|--------|-----|-----|-------|--------|---------|
| EL0080987 | 5W | E14 | 6400K | 425lm | 90lm/W | >80 | Mat | 10000 | 15000h | 82x45mm |
| EL0080988 | | E27 | | | | | | | | 85lm/W |

NOVELITE - BEC LED SFERIC / LED SPHERICAL BULB

| | | | | | | | | | | |
|-----------|----|-----|-------|-------|--------|-----|-----|-------|--------|---------|
| EL0081009 | 5W | E14 | 3000K | 450lm | 90lm/W | >80 | Mat | 15000 | 20000h | 81x45mm |
| EL0081010 | | | 6400K | | | | | | | |
| EL0084219 | 7W | E14 | 3000K | 630lm | 90lm/W | >80 | Mat | 15000 | 20000h | 81x45mm |
| EL0084220 | | | 6400K | | | | | | | |
| EL0081011 | 5W | E27 | 3000K | 450lm | 90lm/W | >80 | Mat | 15000 | 20000h | 79x45mm |
| EL0081012 | | | 6400K | | | | | | | |
| EL0084214 | 7W | E27 | 6400K | 630lm | 90lm/W | >80 | Mat | 15000 | 20000h | 85x45mm |



Sferică E14 / Spherical E14



Sferică E27 / Spherical E27



| RO | Cod | Putere consumată | Dulie | Temp. de culoare | Flux luminos | Randament luminos | CRI | Finisaj | Unghi de distribuție luminoasă | Număr minim de cicluri comutare ON/OFF | Durată de viață nominală | Dimensiuni |
|----|------|------------------|-------|-------------------|---------------|---------------------|-----|---------|--------------------------------|---|--------------------------|------------|
| EN | Code | Power | Base | Color temperature | Luminous flux | Luminous efficiency | CRI | Finish | Beam angle | Minimum number of ON/OFF switching cycles | Nominal service life | Size |

HOMELIGHT - BEC LED SPOT / LED SPOTLIGHT BULB

| | | | | | | | | | | | | |
|-----------|----|--|-------|-------|-------|--------|----|------------|------|-------|--------|---------|
| EL0080989 | | | GU10 | | 400lm | 80lm/W | | | | | | 59x50mm |
| EL0080990 | 5W | | GU5.3 | 6400K | | | 80 | Mat / Matt | 100° | 10000 | 15000h | 52x50mm |
| EL0080991 | | | E14 | | 425lm | 85lm/W | | | 120° | | | 83x50mm |

NOVELITE - BEC LED SPOT / LED SPOT BULB

| | | | | | | | | | | | | |
|-----------|----|--|-------|-------|-------|--------|-----|------------|------|-------|--------|----------|
| EL0082068 | 5W | | GU10 | 3000K | 425lm | | | | | | | 59x50mm |
| EL0081013 | | | | 6400K | | | | | | | | |
| EL0081014 | 7W | | GU10 | 3000K | 600lm | 85lm/W | | | | | | 59x50mm |
| EL0081015 | | | | 6400K | | | | | | | | |
| EL0082069 | 5W | | GU5.3 | 3000K | 425lm | | | | 100° | | | 54x50mm |
| EL0081016 | | | | 6400K | | | | | | | | |
| EL0081017 | 7W | | GU5.3 | 3000K | 600lm | 86lm/W | >80 | Mat / Matt | | 15000 | 20000h | 52x50mm |
| EL0081018 | | | | 6400K | | | | | | | | |
| EL0084216 | 4W | | E14 | 3000K | 340lm | 85lm/W | | | | | | 69x39mm |
| EL0084215 | | | | 6400K | | | | | | | | |
| EL0081020 | 5W | | E14 | 6400K | 450lm | | | | 120° | | | 83x50mm |
| EL0081021 | 7W | | | 6400K | 630lm | 90lm/W | | | | | | |
| EL0081022 | 8W | | E27 | 3000K | 720lm | | | | | | | 100x63mm |
| EL0082074 | | | | 6400K | | | | | | | | |

12V

NOVELITE - BEC LED SPOT / LED SPOTLIGHT BULB

| | | | | | | | | | | | | |
|-----------|-----|--|-------|-------|-------|--------|-----|------------|------|-------|--------|---------|
| EL0082070 | 12W | | GU5.3 | 3000K | 425lm | 85lm/W | >80 | Mat / Matt | 100° | 15000 | 20000h | 54x50mm |
| EL0081019 | | | | 6400K | | | | | | | | |



Spot E14

Spot E27

Spot GU5.3

Spot GU10



| RO | Cod | Putere consumată | Dulie | Tensiune | Temperatură de culoare | Flux luminos | Randament luminos | Formă | Finisaj | Număr minim de cicluri comutare ON/OFF | Durată de viață nominală | Dimensiuni |
|----|------|------------------|-------|----------|------------------------|---------------|---------------------|-------|---------|---|--------------------------|------------|
| EN | Code | Power | Base | Voltage | Color temperature | Luminous flux | Luminous efficiency | Form | Finish | Minimum number of ON/OFF switching cycles | Nominal service life | Size |

NOVELITE - BECURI LED BULB / LED BULBS

| | | | | | | | | | | | | |
|------------|----|-----|----------|--|-------|-------|--------|--------|--------------|-------|--------|---------|
| EL0081023 | 3W | G4 | 12V | | 3000K | 255lm | 85lm/W | | | | | 43x16mm |
| EL0081024 | 5W | G9 | | | | 450lm | 90lm/W | Bulb | Clar / Clear | 25000 | 20000h | 61x16mm |
| EL0081025 | | G9 | 220-240V | | 6400K | | | | | | | |
| EL0081026* | 2W | E14 | | | 3000K | 170lm | 85lm/W | PYGYMY | Mat | 15000 | | 51x22mm |

* Bec LED frigider/hotă / LED bulb for fridge/hood



NOVELITE - BEC LED DE PUTERE MARE / HIGH-POWER LED BULB

| | | | | | | | | | | | | |
|-----------|-----|-----|----------|--|-------|--------|--------|------|------------|-------|--------|-----------|
| EL0081027 | 20W | | | | | 1800lm | | T80 | | | | 138x80mm |
| EL0081028 | 30W | | | | | 2700lm | | T100 | | | | 166x100mm |
| EL0081029 | 40W | E27 | 220-240V | | 6400K | 3600lm | 90lm/W | T120 | Mat / Matt | 15000 | 20000h | 185x116mm |
| EL0084211 | 50W | | | | | 4500lm | | T140 | | | | 220x140mm |
| EL0082073 | 80W | | | | | 7200lm | | T140 | | | | 225x140mm |



G4

G9

LED frigider/hotă / LED bulb for fridge/hood

LED de putere mare / High-power LED bulb



| RO | Cod | Putere consumată | Dulie | Temperatură de culoare | Flux luminos | Randament luminos | Formă | Finisaj | Număr minim de cicluri comutare ON/OFF | Durată de viață nominală | Dimensiuni |
|----|------|------------------|-------|------------------------|---------------|---------------------|-------|---------|---|--------------------------|------------|
| EN | Code | Power | Base | Color temperature | Luminous flux | Luminous efficiency | Form | Finish | Minimum number of ON/OFF switching cycles | Nominal service life | Size |

NOVELITE - BEC LED FILAMENT / LED FILAMENT BULB

| | | | | | | | | | | |
|-----------|----|-----|-------|-------|---------|--------------------|--------------|-------|--------|----------|
| EL0082075 | 4W | E27 | 2700K | 400lm | 100lm/W | A60 | Clar / Clear | 15000 | 20000h | 109x60mm |
| EL0081030 | 8W | | | 800lm | | | | | | 105x60mm |
| EL0081031 | 6W | E27 | 2200K | 540lm | 90lm/W | G95 | Auriu / Gold | 15000 | 20000h | 138x95mm |
| EL0081032 | 8W | | | | | | | | | ST64 |
| EL0082077 | 6W | E14 | 2700K | 400lm | 100lm/W | Lumânare / Candle | Clar / Clear | 15000 | 20000h | 98x35mm |
| EL0081033 | 4W | | | | | | | | | 99x35mm |
| EL0082078 | 4W | E14 | 6500K | 400lm | 100lm/W | Sferic / Spherical | Clar / Clear | 15000 | 20000h | 79x45mm |
| EL0082079 | 4W | | | | | | | | | 76x45mm |
| EL0081034 | 2W | E27 | 2700K | 200lm | | | | | | 75x45mm |
| EL0084212 | 2W | E27 | 2700K | 200lm | | | | | | 75x45mm |



A60 Clar / A60 Clear



Lumânare Clar / Candle Clear



Sferic Clar / Spherical Clear



G95 Auriu / G95 Gold



ST64 Auriu / ST64 Gold



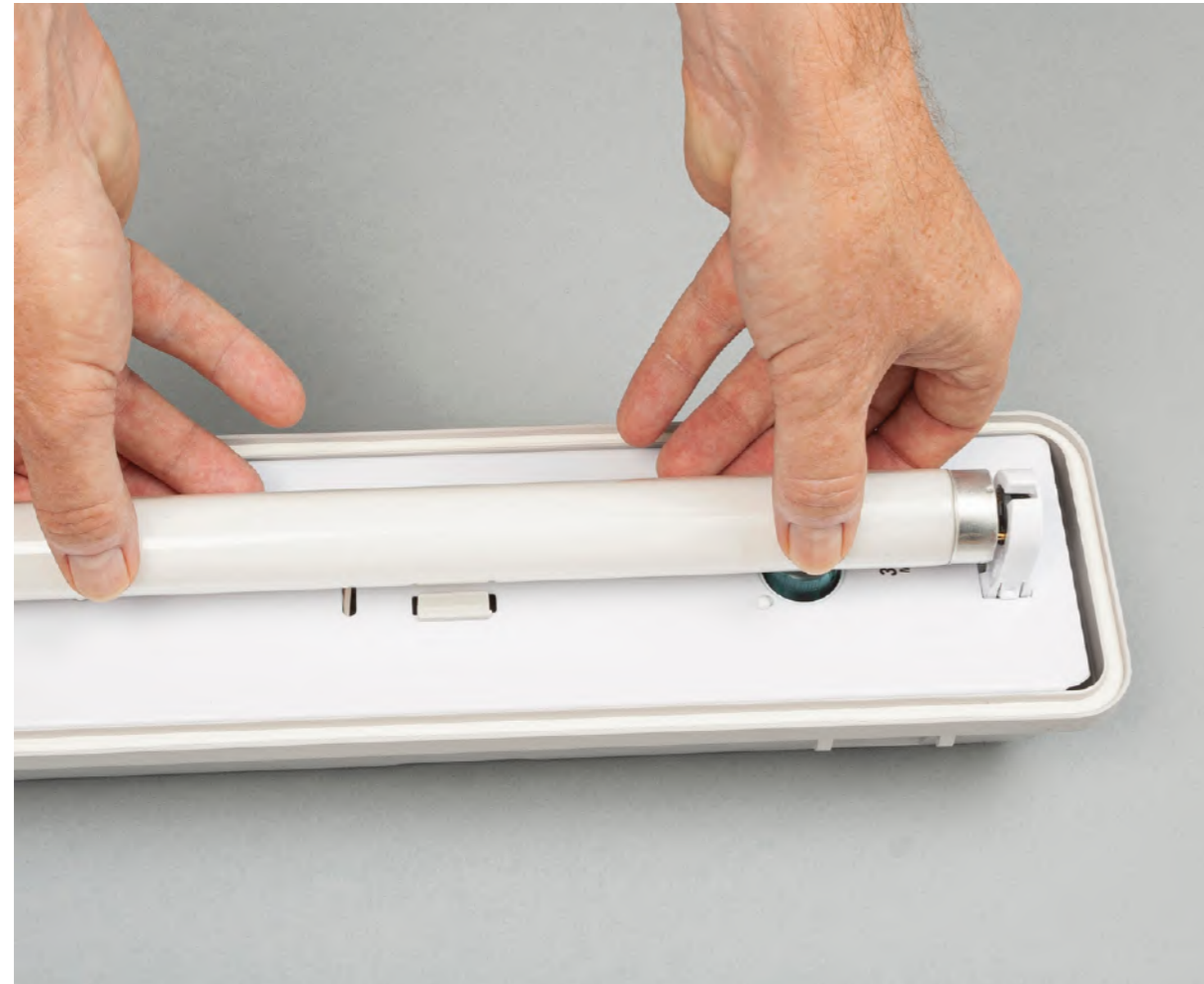

TUB LED LED TUBE

RO

Tuburile LED oferă o soluție eficientă și durabilă pentru iluminatul spațiilor rezidențiale, comerciale sau industriale. Acestea sunt concepute pentru a înlocui tuburile fluorescente tradiționale, oferind o lumină uniformă și o eficiență energetică superioară.

REPERE

- **Eficiență energetică** – consum redus de energie, reducând costurile la factură;
- **Durată de viață extinsă** – rezistă mai mult decât tuburile convenționale, minimizând necesitatea înlocuirii;
- **Lumină instantanee** – se aprinde imediat, fără întârziere sau timp de încălzire.

EN

LED tubes provide an efficient and durable solution for lighting residential, commercial, or industrial spaces. Designed to replace traditional fluorescent tubes, they deliver uniform light with superior energy efficiency.

FEATURES

- **Energy efficiency** – lower energy consumption, reducing electricity bills;
- **Extended lifespan** – lasts longer than conventional tubes, minimizing replacement needs;
- **Instant brightness** – lights up immediately without delays or warm-up time.



| RO | Cod | Putere consumată | Dulie | Temperatură de culoare | Flux luminos | Randament luminos | CRI | Finisaj | Număr minim de cicluri comutare ON/OFF | Durată de viață nominală | Dimensiuni |
|----|------|------------------|-------|------------------------|---------------|---------------------|-----|---------|---|--------------------------|------------|
| EN | Code | Power | Base | Color temperature | Luminous flux | Luminous efficiency | CRI | Finish | Minimum number of ON/OFF switching cycles | Nominal service life | Size |

HOMELIGHT - TUB LED / LED TUBE

| | | | | | | | | | | |
|-----------|-----|-----|-------|--------|--------|----|---------------|-------|--------|-----------|
| EL0081035 | 8W | G13 | 6400K | 680lm | 85lm/W | 70 | Mat / Matt | 10000 | 15000h | 605x28mm |
| EL0081036 | 16W | | | 1400lm | 88lm/W | | | | | 1212x28mm |

NOVELITE - TUB LED / LED TUBE

| | | | | | | | | | | |
|-----------|-----|-----|-------|--------|---------|----|---------------|-------|--------|-----------|
| EL0081037 | 9W | G13 | 3000K | 800lm | 89lm/W | 80 | Mat / Matt | 15000 | 20000h | 605x28mm |
| EL0081038 | | | 4000K | | | | | | | |
| EL0081039 | | | 6400K | | | | | | | |
| EL0082081 | 14W | G13 | 3000K | 1260lm | 90lm/W | 80 | Mat / Matt | 15000 | 20000h | 906x28mm |
| EL0082071 | 18W | | | 1620lm | | | | | | |
| EL0082080 | 18W | | | 4000K | | | | | | |
| EL0084221 | 24W | G13 | 6400K | 2400lm | 100lm/W | 80 | Mat / Matt | 15000 | 20000h | 1213x28mm |
| EL0081040 | | | 4000K | | | | | | | |
| EL0082072 | | | 6400K | | | | | | | |



Tub LED / LED Tube



BEC HALOGEN HALOGEN BULB

RO

Becurile halogene sunt o variantă eficientă și mai luminoasă a becurilor incandescente tradiționale, oferind o iluminare clară și vibrantă. Acestea sunt ideale pentru iluminatul de accent, spoturi sau pentru orice spațiu care necesită o lumină intensă, dar mai economică decât becurile incandescente.

REPERE

- **Luminozitate puternică** – emite o lumină mai clară și mai strălucitoare decât becurile incandescente;
- **Eficiență îmbunătățită** – consum mai mic de energie în comparație cu becurile tradiționale;
- **Durată de viață mai lungă** – durează mai mult decât becurile incandescente, oferind un raport mai bun calitate-preț.

EN

Halogen bulbs are a more efficient and brighter version of traditional incandescent bulbs, offering clear and vibrant lighting. They are ideal for accent lighting, spotlights, or any space that requires intense illumination, while being more energy-efficient than incandescent bulbs.

FEATURES

- **Powerful brightness** – provides a clearer and brighter light compared to incandescent bulbs;
- **Improved efficiency** – lower energy consumption than traditional bulbs;
- **Longer lifespan** – lasts longer than incandescent bulbs, offering a better quality price ratio.



| RO | Cod | Putere consumată | Dulie | Tensiune | Temperatură de culoare | Flux luminos | Număr minim de cicluri comutare ON/OFF | Durată de viață nominală | Dimensiuni |
|----|------|------------------|-------|----------|------------------------|---------------|---|--------------------------|------------|
| EN | Code | Power | Base | Voltage | Color temperature | Luminous flux | Minimum number of on/off switching cycles | Nominal service life | Size |

TOTAL GREEN - BEC HALOGEN BULB CLAR / CLEAR HALOGEN BULB

| | | | | | | | | |
|-----------|-----|-------|----------|-------|---------|------|-------|---------|
| EL0068609 | 8W | G4 | 12V | 2800K | 70lm | 2000 | 2000h | 30x8mm |
| EL0068374 | 16W | | | | 200lm | | | 28x8mm |
| EL0020424 | 35W | | | | 420lm | | | 31x8mm |
| EL0025163 | 25W | G6.35 | 220-240V | 2800K | 180lm | 2000 | 2000h | 43x13mm |
| EL0021373 | 35W | | 455lm | | 39x10mm | | | |
| EL0021374 | 50W | | 650lm | | 45x13mm | | | |
| EL0021372 | 35W | G9 | 220-240V | 2800K | 262lm | 2000 | 2000h | 45x13mm |
| EL0021370 | 50W | | | | 450lm | | | 40x13mm |
| EL0068610 | 20W | | | | 180lm | | | 40x13mm |
| EL0068375 | 32W | G9 | 220-240V | 2800K | 400lm | 2000 | 2000h | 40x13mm |
| EL0068376 | 40W | | | | 500lm | | | |



Halogen G4



Halogen G6.35



Halogen G9

SURSE DE ILUMINAT | BEC HALOGEN



| RO | Cod | Putere consumată | Dulie | Tensiune | Temperatură de culoare | Flux luminos | Număr minim de cicluri comutare ON/OFF | Durată de viață nominală | Unghi de distribuție luminoasă | Dimensiuni |
|----|------|------------------|-------|----------|------------------------|---------------|---|--------------------------|--------------------------------|------------|
| EN | Code | Power | Base | Voltage | Color temperature | Luminous flux | Minimum number of ON/OFF switching cycles | Nominal service life | Beam angle | Size |

TOTAL GREEN - BEC HALOGEN SPOT CLAR / CLEAR HALOGEN SPOT BULB

| | | | | | | | | |
|-----------|-----|-----------------|-------------|-------|-------|---------|---------|---------|
| EL0009517 | 20W | GU4 | 12V | 2800K | 180lm | 4000h | 20° | 35x35mm |
| EL0009518 | 35W | | | | 350lm | | | |
| EL0009519 | 50W | | | | 400lm | | | |
| EL0025160 | 20W | | 220-240V | | 120lm | 4000 | | |
| EL0025161 | 35W | | | | 270lm | 2800 | 30° | 45x35mm |
| EL0025162 | 50W | | | | 400lm | 2000 | | |
| EL0068614 | 28W | GU5.3 | 12V | 2800K | 250lm | 4000h | 24° | 55x50mm |
| EL0068615 | 40W | | | | 360lm | | | |
| EL0009511 | 20W | | | | 120lm | | | |
| EL0009512 | 35W | | 270lm | | 2000h | 40° | 45x50mm | |
| EL0009513 | 50W | | 400lm | | | | | |
| EL0011018 | 50W | | Bleu / Blue | | | | | - |
| EL0011019 | 50W | Galben / Yellow | - | | | | | |
| EL0011020 | 50W | Roșu / Red | - | | | | | |
| EL0011021 | 50W | Verde / Green | - | | | | | |
| EL0068613 | 28W | GU10 | 2800K | 180lm | 4000h | 55x50mm | | |
| EL0068380 | 42W | | | 320lm | | | | |
| EL0004666 | 75W | | | 675lm | | | | |



Halogen GU4



Halogen GU5.3



Halogen GU10

LIGHT SOURCES | HALOGEN BULB



| RO | Cod | Putere consumată | Dulie | Temperatură de culoare | Flux luminos | Număr minim de cicluri comutare ON/OFF | Durată de viață nominală | Dimensiuni |
|----|------|------------------|-------|------------------------|---------------|---|--------------------------|------------|
| EN | Code | Power | Base | Color temperature | Luminous flux | Minimum number of ON/OFF switching cycles | Nominal service life | Size |

TOTAL GREEN - BEC HALOGEN LINIAR CLAR / LINEAR CLEAR HALOGEN BULB

| | | | | | | | |
|-----------|-------|------|-------|---------|----------|-------|---------|
| EL0068611 | 80W | R7S | 2800K | 1300lm | 2000 | 2000h | 78x10mm |
| EL0068612 | 120W | | | 1800lm | | | |
| EL0068377 | | | | 4000lm | | | |
| EL0068378 | 230W | 2000 | 2000h | 4000lm | 254x10mm | | |
| EL0068379 | 400W | | | 6800lm | | | |
| EL0004660 | 1000W | | | 16000lm | | | |
| EL0026009 | 1500W | | | 24000lm | | | |



Halogen R7S



BEC INCANDESCENT INCANDESCENT BULB

RO

Becurile incandescente sunt una dintre cele mai tradiționale surse de iluminat, oferind o lumină caldă și plăcută. Acestea sunt ideale pentru crearea unui ambient confortabil și relaxant în orice spațiu, fiind potrivite pentru utilizare generală în locuințe și birouri.

REPERE

- **Lumină caldă** – oferă o iluminare naturală și plăcută, ideală pentru crearea unei atmosfere relaxante acasă;
- **Simplitate și accesibilitate** – ușor de găsit și la un preț accesibil;
- **Compatibilitate largă** – se potrivesc majorității soclurilor și sunt ideale pentru lămpi de orice tip.

EN

Incandescent bulbs are one of the most traditional light sources, providing a warm and pleasant light. They are ideal for creating a cozy and relaxing atmosphere in any space, perfect for general use in homes and offices.

FEATURES

- **Warm light** – delivers a natural, soft illumination, ideal for creating a relaxing atmosphere at home;
- **Simplicity and affordability** – widely available and budget-friendly;
- **Wide compatibility** – fits most sockets, making them suitable for various lamps.



| RO | Cod | Putere consumată | Dulie | Tensiune | Temperatură de culoare | Flux luminos | Formă | Finisaj | Număr minim de cicluri comutare ON/OFF | Durată de viață nominală | Dimensiuni |
|----|------|------------------|-------|----------|------------------------|---------------|-------|---------|---|--------------------------|------------|
| EN | Code | Power | Base | Voltage | Color temperature | Luminous flux | Form | Finish | Minimum number of ON/OFF switching cycles | Nominal service life | Size |

TOTAL GREEN - BEC INCANDESCENT / INCANDESCENT BULB

| | | | | | | | | | | |
|-----------|-----|-----|----------|-------|-------|-------|--------------|-------|----------|---------|
| EL0026232 | 15W | E14 | 220-240V | 2800K | 100lm | PYGMY | Clar / Clear | 1000 | 1000h | 48x22mm |
| EL0026233 | 40W | | | | 300lm | | | | | 59x26mm |
| EL0026234 | 40W | E27 | 24V | 2800K | 880lm | A60 | 2000 | 1000h | 107x60mm | |
| EL0030743 | 60W | | | | 880lm | | | | 107x60mm | |



Incandescent E27 / E27 incandescent bulb



Incandescent E14 / E14 incandescent bulb

TOTAL GREEN - BEC CU INFRAROȘU / INFRARED BULB

| | | | | | | | | | | |
|-----------|------|-----|----------|----------------------|---|------|------------|-------|-------|-----------|
| EL0041670 | 100W | E27 | 220-240V | Infraroșu / Infrared | - | R95 | Roșu / Red | 2000 | 300h | 125x95mm |
| EL0041671 | 150W | | | | - | R125 | | 12000 | 5000h | 175x125mm |
| EL0041672 | 250W | - | - | - | - | - | - | - | - | |



Bec infraroșu R95 / R95 infrared bulb



Bec infraroșu R125 / R125 infrared bulb

SMART HOME

SMART HOME

Soluții pentru case smart - Smart home solutions

| 204



SOLUȚII PENTRU CASE SMART SMART HOME SOLUTIONS

RO

Gama de soluții PULSAR Smart redefinește controlul și eficiența energetică prin tehnologie avansată, oferind un sistem integrat de automatizare pentru locuințe, birouri și spații comerciale. Echipate cu tehnologia Tuya, dispozitivele PULSAR asigură monitorizare, control și optimizare în timp real, contribuind la reducerea consumului de energie și creșterea performanței operaționale.

REPERE

- Conectare dispozitive diverse și multiple;
- Diverse protocoale de conectare;
- Permite detectarea automată și adăugarea în aplicație cu un singur click;
- Aplicația suportă control manual și control vocal, inclusiv integrare cu aplicații terțe;
- Monitorizarea consumului de energie.

EN

The PULSAR Smart range redefines control and energy efficiency through advanced technology, offering an integrated automation system for homes, offices, and commercial spaces. Equipped with Tuya technology, PULSAR devices ensure real-time monitoring, control, and optimization, helping to reduce energy consumption and enhance operational performance.

FEATURES

- Connect various and multiple devices;
- Various connection protocols;
- Allows automatic detection and addition to the application with one click;
- The application supports manual control and voice control, including integration with third-party applications;
- Energy consumption monitoring.

SCANEAZĂ CODUL QR
ȘI DESCARCĂ APLICAȚIA



| RO | Cod | Putere | Dulie | Flux luminos | CRI | Unghi de distribuție luminoasă | Formă | Finisaj | Dimensiuni | Clasa energetică |
|----|------|--------|--------|---------------|-----|--------------------------------|-------|---------|------------|-------------------------|
| EN | Code | Power | Socket | Luminous flux | CRI | Beam angle | Form | Finish | Size | Energy efficiency class |

PULSAR - SURSĂ LED SMART RGB + ALB / SMART RGB + WHITE LED LIGHT SOURCE

| | | | | | | | | | |
|-----------|-----|-----|-------|----|------|-------------------|------------|----------|--|
| EL0060533 | 10W | E27 | 800lm | 80 | 180° | A60 | Mat / Matt | 108x60mm | |
| EL0060534 | 6W | E14 | 480lm | | | Lumânare / Candel | | 100x37mm | |



EL0060533



EL0060534



| RO | Cod | Putere | Curent nominal | Dimensiuni |
|----|------|--------|----------------|------------|
| EN | Code | Power | Nominal curent | Size |

PULSAR - PRIZĂ SMART SCHUKO / SMART SCHUKO SOCKET

| | | | |
|-----------|-------|-----|---------|
| EL0060410 | 3680W | 16A | 84x54mm |
|-----------|-------|-----|---------|



EL0060410



| | | | | | |
|----|------|----------------|----------------------|------------------------|---------------|
| RO | Cod | Calitate video | Unghi de vizualizare | Vizibilitate Zi/Noapte | Notificări |
| EN | Code | Video Quality | Viewing Angle | Day/Night Visibility | Notifications |



EL0067820

PULSAR
CAMERĂ BULLET SMART HD / SMART HD VIDEO BULLET

| | | | | |
|-----------|---------------------|-----|---------|----------|
| EL0067820 | Full HD 1920x1080px | 75° | 45m/15m | Da / Yes |
|-----------|---------------------|-----|---------|----------|

i Microfon și difuzor încorporat.
Built-in microphone and speaker.



| | | | | | | |
|----|------|----------------|-------------------|---------|------------------------|---------------|
| RO | Cod | Calitate video | PT prin aplicație | Lentilă | Vizibilitate Zi/Noapte | Notificări |
| EN | Code | Video Quality | PT via app | Lens | Day/Night Visibility | Notifications |



EL0067821

PULSAR
CAMERĂ VIDEO SMART HD PT/ SMART HD VIDEO PT

| | | | | | |
|-----------|--------------------|------------|-----------|-----|----------|
| EL0067821 | Full HD 1920x1080p | 350°+/-75° | 2Mpx CMOS | 10m | Da / Yes |
|-----------|--------------------|------------|-----------|-----|----------|

i Microfon și difuzor încorporat.
Built-in microphone and speaker.



| | | | | | | | |
|----|------|----------------|----------------------|-------------|------------------------|-------------------------|------------|
| RO | Cod | Calitate video | Unghi de vizualizare | Semnal WIFI | Vizibilitate Zi/Noapte | Senzor de prezență PIR | Dimensiuni |
| EN | Code | Video Quality | Viewing Angle | WIFI Signal | Day/Night Visibility | Motion detection sensor | Size |



EL0067407

PULSAR - SONERIE VIDEO SMART / SMART VIDEO DOORBELL

| | | | | | | |
|-----------|---------------------|------|--------------------|----|------|-------------|
| EL0067407 | Full HD 1920x1080px | 145° | ext. 50m, int. 20m | 5m | 4-5m | 62x41x133mm |
|-----------|---------------------|------|--------------------|----|------|-------------|

i Acumulatori reîncărcabili de tip 18650 - 6700mAh.
Rechargeable batteries type 18650 - 6700mAh.



| | | | | | | |
|----|------|-----------------|--|------------------------|----------|-------------------------|
| RO | Cod | Frecvență radio | Distanță de transmisie în spațiu deschis | Reglaj temperatură | Precizie | Increment/Sensibilitate |
| EN | Code | Radio frequency | Open space transmission distance | Temperature adjustment | Accuracy | Increment/Sensitivity |



EL0068503

PULSAR - TERMOSTAT SMART WIFI / SMART WIFI THERMOSTAT

| | | | | | |
|-----------|--------|-----|-------------|-------|-------|
| EL0068503 | 868Mhz | 80m | +5..+29.5°C | 0,1°C | 0,5°C |
|-----------|--------|-----|-------------|-------|-------|

i Două moduri de conectare cu centrala termică: cu fir sau fără fir.
Two ways to connect to the heating system: wired or wireless.



| | | | | | | |
|----|------|--------|------------------------|---------------|--------------------|--------------|
| RO | Cod | Putere | Temperatură de culoare | Nr. alarme | Sunete predefinite | Putere sunet |
| EN | Code | Power | Color temperature | No. of alarms | Predefined sounds | Sound power |



EL0067743

PULSAR - CEAS REMY SMART / REMY SMART CLOCK

| | | | | | |
|-----------|----|-----------------------|---|----|----|
| EL0067743 | 6W | RGB & CCT 2700-5700°K | 4 | 17 | 2W |
|-----------|----|-----------------------|---|----|----|



| | | | | | | |
|----|------|--------|---------------|------------------------|--------------------|----------|
| RO | Cod | Putere | Flux luminos | Temperatură de culoare | Unghi de Dispersie | Tip Led |
| EN | Code | Power | Luminous flux | Color temperature | Beam angle | LED Type |



EL0067802

PULSAR - SPOT SMART WIFI PRIME / SMART WIFI PRIME SPOTLIGHT

| | | | | | |
|-----------|----|-------|-----------------------|-----|------|
| EL0067802 | 5W | 345lm | RGB & CCT 2700-6500°K | 45° | 2835 |
|-----------|----|-------|-----------------------|-----|------|



| | | | | | |
|----|------|--------|------------------------|----------|------------|
| RO | Cod | Putere | Temperatură de culoare | Tip LED | Dimensiuni |
| EN | Code | Power | Color temperature | LED Type | Size |

PULSAR - KIT SMART BANDĂ LED / LED SMART STRIP KIT

| | | | | |
|-----------|-----|--------------------------|-----------|----|
| EL0067811 | 24W | RGB & CCT 3000~6000°K | 5050/2835 | 5m |
|-----------|-----|--------------------------|-----------|----|



EL0067811



| | | | | | | |
|----|------|--------|---------------|------------------------|----------|------------|
| RO | Cod | Putere | Flux luminos | Temperatură de culoare | Tip LED | Dimensiuni |
| EN | Code | Power | Luminous flux | Color temperature | LED Type | Size |

PULSAR PLAFONIERĂ SMART WIFI JOY / JOY SMART WIFI CEILING LAMP

| | | | | | |
|-----------|-----|--------|--------------------------|------|----------|
| EL0067801 | 20W | 1400lm | RGB & CCT 2700~6500°K | 2835 | 280x80mm |
|-----------|-----|--------|--------------------------|------|----------|



EL0067801



| | | | | | | |
|----|------|--------|---------------|------------------------|----------|------------|
| RO | Cod | Putere | Flux luminos | Temperatură de culoare | Tip LED | Dimensiuni |
| EN | Code | Power | Luminous flux | Color temperature | LED Type | Size |

PULSAR PLAFONIERĂ SMART GOLD RING / GOLD RING SMART CEILING LAMP

| | | | | | |
|-----------|-----|--------|--------------------|------|----------|
| EL0060110 | 36W | 1450lm | CCT 3000~6500°K | 2835 | 550x82mm |
|-----------|-----|--------|--------------------|------|----------|



EL0060110



| | | | | | | |
|----|------|--------|---------------|------------------------|----------|------------|
| RO | Cod | Putere | Flux luminos | Temperatură de culoare | Tip LED | Dimensiuni |
| EN | Code | Power | Luminous flux | Color temperature | LED Type | Size |

PULSAR - PLAFONIERĂ SMART / SMART CEILING LAMP

| | | | | | |
|-----------|-----|--------|--------------------|------|----------|
| EL0060112 | 36W | 1750lm | CCT 3000~6500°K | 2835 | 525x75mm |
|-----------|-----|--------|--------------------|------|----------|



EL0060112



| | | | | | | |
|----|------|--------|---------------|------------------------|----------|------------|
| RO | Cod | Putere | Flux luminos | Temperatură de culoare | Tip LED | Dimensiuni |
| EN | Code | Power | Luminous flux | Color temperature | LED Type | Size |

PULSAR PLAFONIERĂ SMART LUXERA / LUXERA SMART CEILING LAMP

| | | | | | |
|-----------|-----|--------|--------------------|------|----------|
| EL0060113 | 36W | 2200lm | CCT 3000~6500°K | 2835 | 505x70mm |
|-----------|-----|--------|--------------------|------|----------|



EL0060113



| | | | | | | |
|----|------|--------|---------------|------------------------|----------|------------|
| RO | Cod | Putere | Flux luminos | Temperatură de culoare | Tip LED | Dimensiuni |
| EN | Code | Power | Luminous flux | Color temperature | LED Type | Size |

PULSAR PLAFONIERĂ SMART LIULI / LIULI SMART CEILING LAMP

| | | | | | |
|-----------|-----|--------|--------------------|------|----------|
| EL0060108 | 36W | 2200lm | CCT 3000~6500°K | 2835 | 495x70mm |
|-----------|-----|--------|--------------------|------|----------|



EL0060108



| | | | | | | |
|----|------|--------|---------------|------------------------|----------|------------|
| RO | Cod | Putere | Flux luminos | Temperatură de culoare | Tip LED | Dimensiuni |
| EN | Code | Power | Luminous flux | Color temperature | LED Type | Size |

PULSAR PLAFONIERĂ SMART LORD RING / LORD RING SMART CEILING LAMP

| | | | | | |
|-----------|-----|--------|--------------------|------|----------|
| EL0060109 | 36W | 2300lm | CCT 3000~6500°K | 2835 | 495x70mm |
|-----------|-----|--------|--------------------|------|----------|



EL0060109

APARATAJ

SWITCHES AND SOCKETS

| | |
|--|-----|
| Gama de aparataj touch - Pulsar touch product range | 212 |
| Gama de aparataj Moda Voice - Moda Voice product range | 216 |
| Gama de aparataj Jazz - Jazz product range | 222 |
| Gama de aparataj Zena - Zena product range | 228 |
| Gama de aparataj Zirve - Zirve product range | 236 |
| Gama de aparataj Alsu - Alsu product range | 242 |
| Gama de aparataj Eva - Eva product range | 246 |
| Gama de aparataj Total Green - Total Green product range | 250 |
| Gama de aparataj Novelite - Novelite product range | 252 |



GAMA DE APARATAJ TOUCH PULSAR TOUCH PRODUCT RANGE

RO

Gama de aparataj Pulsar, echipată cu tehnologie touch și standard german, combină designul elegant cu funcționalitatea de top. Designul lor minimalist îmbinat cu tehnologia de ultimă generație, fac din gama de aparataj touch PULSAR alegerea potrivită pentru orice locuință. Modulul întrerupătorului are încorporat un LED de semnalizare albastru în fiecare buton tactil, fiind astfel ușor de localizat pe întuneric. Culoarea albastru aprins semnalizează că întrerupătorul este pornit, iar culoarea albastru pal arată că întrerupătorul este oprit. Instalarea se face fără fire suplimentare (nu necesita NUL), produsul fiind compatibil cu instalațiile electrice existente.

REPERE

- **Gamă completă** - include întrerupătoare, prize, panouri și rame;
- **Instalare simplă, fără fire** - nu necesită NUL;
- **Montaj în doză rotundă** - standard german;
- **Senzor tactil** - care poate fi operat și în condiții de umiditate crescută;
- **Sticlă securizată de 4mm** - rezistentă la zgârieturi.

EN

The Pulsar range of switches and sockets, equipped with touch technology and German standards, combines elegant design with top functionality. Its minimalist design, paired with cutting-edge technology, makes the PULSAR touch switches and sockets range the ideal choice for any home. The switch module features a built-in blue LED indicator in each touch button, making it easy to locate in the dark. The bright blue color indicates that the switch is on, while the light blue color shows that the switch is off. Installation is straightforward with no additional wiring required (no NUL needed), and the product is compatible with existing electrical installations.

FEATURES

- **Complete range** - includes switches, sockets, panels, and frames;
- **Easy installation** - no additional wiring required - no NUL needed;
- **German standard** - compatible with standard round electrical boxes;
- **Touch sensor** - operable even in high humidity conditions;
- **4mm tempered glass** - scratch - resistant and durable.



MODUL

ÎNTRERUPĂTOR SIMPLU
SINGLE SWITCH



Cod / Code
EL0068222

ÎNTRERUPĂTOR DUBLU
DOUBLE SWITCH

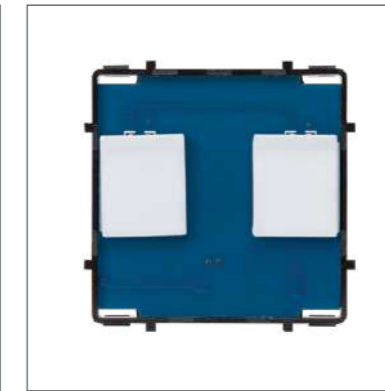

Cod / Code
EL0068223

ÎNTRERUPĂTOR CAP-SCARĂ/CRUCE
TWO WAY / INTERMEDIATE SWITCH

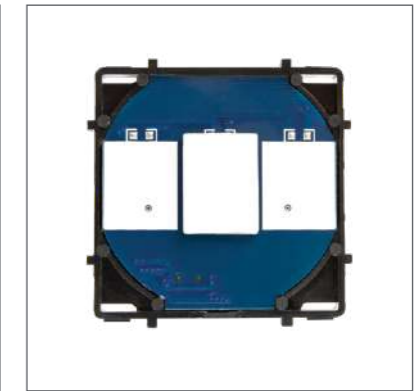

Cod / Code
EL0068225

ÎNTRERUPĂTOR DUBLU
CAP-SCARĂ / CRUCE
DOUBLE TWO WAY / CROSS SWITCH



Cod / Code
EL0068442

PRIZĂ SCHUKO 16A
16A SCHUKO SOCKET

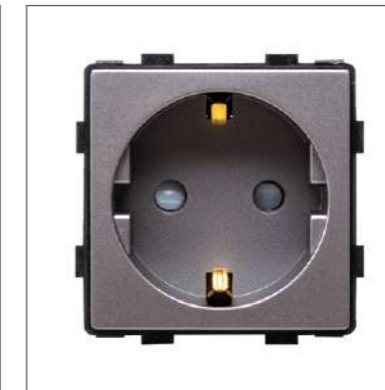

| | |
|------------|-----------------|
| Cod / Code | Culoare / Color |
| EL0068226 | Alb / White |
| EL0068932 | Gri / Gray |

ADAPTOR PRIZĂ TV / UTP / USB
TV / UTP / USB SOCKET ADAPTER

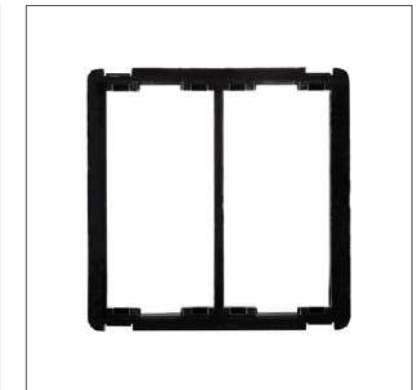

| | |
|------------|-----------------|
| Cod / Code | Culoare / Color |
| EL0072680 | Negru / Black |

PRIZĂ TV F 1/2
TV SOCKET F 1/2



| | |
|------------|-----------------|
| Cod / Code | Culoare / Color |
| EL0068926 | Alb / White |
| EL0070517 | Gri / Gray |

PRIZĂ UTP CAT 6E 1/2
CAT 6E 1/2 UTP SOCKET



| | |
|------------|-----------------|
| Cod / Code | Culoare / Color |
| EL0070031 | Alb / White |
| EL0071109 | Gri / Gray |

TASTĂ FALSĂ 1/2
BLIND COVER



| | |
|------------|-----------------|
| Cod / Code | Culoare / Color |
| EL0068927 | Alb / White |
| EL0070518 | Gri / Gray |

PANOURI STICLĂ / GLASS PANELS



SIMPLU 1T / SINGLE 1T



| Cod / Code | Culoare / Color | Dimensiune / Size |
|------------|-----------------|-------------------|
| EL0068227 | Alb / White | 86x86mm |
| EL0068933 | Gri / Gray | |

SIMPLU 2T / SINGLE 2T



| Cod / Code | Culoare / Color | Dimensiune / Size |
|------------|-----------------|-------------------|
| EL0068228 | Alb / White | 86x86mm |
| EL0068934 | Gri / Gray | |

DUBLU 1T+1T / DOUBLE 1T+1T

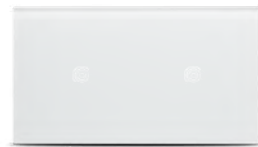

| Cod / Code | Culoare / Color | Dimensiune / Size |
|------------|-----------------|-------------------|
| EL0068452 | Alb / White | 157x86mm |
| EL0068935 | Gri / Gray | |

DUBLU 2T+1T / DOUBLE 2T+1T



| Cod / Code | Culoare / Color | Dimensiune / Size |
|------------|-----------------|-------------------|
| EL0068581 | Alb / White | 157x86mm |
| EL0068937 | Gri / Gray | |

DUBLU 2T+2T / DOUBLE 2T+2T



| Cod / Code | Culoare / Color | Dimensiune / Size |
|------------|-----------------|-------------------|
| EL0068230 | Alb / White | 157x86mm |
| EL0068936 | Gri / Gray | |

DUBLU 1P+1T / DOUBLE 1P+1T



| Cod / Code | Culoare / Color | Dimensiune / Size |
|------------|-----------------|-------------------|
| EL0068450 | Alb / White | 157x86mm |
| EL0068939 | Gri / Gray | |

TRIPLU 1T+1T+1T / TRIPLE 1T+1T+1T

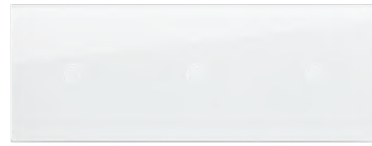

| Cod / Code | Culoare / Color | Dimensiune / Size |
|------------|-----------------|-------------------|
| EL0068583 | Alb / White | 228x86mm |
| EL0068938 | Gri / Gray | |

TRIPLU 2T+2T / TRIPLE 2T+2T



| Cod / Code | Culoare / Color | Dimensiune / Size |
|------------|-----------------|-------------------|
| EL0070070 | Alb / White | 228x86mm |

PANOURI STICLĂ / GLASS PANELS



DUBLĂ 1P+2T / DOUBLE 1P+2T



| Cod / Code | Culoare / Color | Dimensiune / Size |
|------------|-----------------|-------------------|
| EL0068233 | Alb / White | 157x86mm |
| EL0068940 | Gri / Gray | |

TRIPLU 2P+2T / TRIPLE 2P+2T



| Cod / Code | Culoare / Color | Dimensiune / Size |
|------------|-----------------|-------------------|
| EL0068582 | Alb / White | 228x86mm |
| EL0068941 | Gri / Gray | |

TRIPLĂ 2P+1T / TRIPLE 2P+1T



| Cod / Code | Culoare / Color | Dimensiune / Size |
|------------|-----------------|-------------------|
| EL0068842 | Alb / White | 228x86mm |
| EL0068943 | Gri / Gray | |

RAMĂ 1P / FRAME 1P



| Cod / Code | Culoare / Color | Dimensiune / Size |
|------------|-----------------|-------------------|
| EL0068234 | Alb / White | 86x86mm |
| EL0068944 | Gri / Gray | |

RAMĂ 2P / FRAME 2P



| Cod / Code | Culoare / Color | Dimensiune / Size |
|------------|-----------------|-------------------|
| EL0068235 | Alb / White | 157x86mm |
| EL0068945 | Gri / Gray | |

RAMĂ 3P / FRAME 3P



| Cod / Code | Culoare / Color | Dimensiune / Size |
|------------|-----------------|-------------------|
| EL0068236 | Alb / White | 228x86mm |
| EL0068946 | Gri / Gray | |

RAMĂ 4P / FRAME 4P



| Cod / Code | Culoare / Color | Dimensiune / Size |
|------------|-----------------|-------------------|
| EL0068237 | Alb / White | 320x86 |
| EL0068947 | Gri / Gray | |

RAMĂ 5P / FRAME 5P



| Cod / Code | Culoare / Color | Dimensiune / Size |
|------------|-----------------|-------------------|
| EL0068238 | Alb / White | 373x92mm |
| EL0068948 | Gri / Gray | |



GAMA DE APARATAJ MODA VOICE MODA VOICE PRODUCT RANGE

RO

Gama de aparataj Moda Voice este concepută în format modular, compatibilă cu montajul în doză modulară/rectangulară, oferind flexibilitate și adaptabilitate pentru diverse configurații electrice. Aceste dispozitive sunt ideale pentru utilizarea în spații interioare, având un grad de protecție IP20. Montajul se poate realiza atât pe verticală, cât și pe orizontală, permițând o integrare ușoară. Moda Voice combină funcționalitatea cu designul, oferind o soluție eficientă și versatilă pentru instalațiile electrice moderne.

REPERE

- **Flexibilitate** - permite configurări personalizate pentru diverse aplicații;
- **Montaj ușor** - se instalează rapid în doze modulare sau rectangulare;
- **Design modern** - combină estetică și funcționalitatea în orice mediu.

EN

The Moda Voice range of electrical devices is designed in a modular format, compatible with installation in modular/rectangular boxes, offering flexibility and adaptability for various electrical configurations. These devices are ideal for use in indoor spaces, with an IP20 protection rating. The installation can be done both vertically and horizontally, allowing easy integration. Moda Voice combines functionality with design, providing an efficient and versatile solution for modern electrical installations.

FEATURES

- **Flexibility** - allows customized configurations for various applications;
- **Easy installation** - quick installation in modular or rectangular boxes;
- **Modern design** - combines aesthetics and functionality in any environment.

10A 230V IP20 ST

MODULE / MODULE

ÎNTRERUPĂTOR - 1M 1M - SWITCH



| Cod / Code | Culoare / Colors |
|------------|--------------------------------|
| EL0074809 | Alb / White |
| EL0074834 | Alb mat / Matt white |
| EL0074855 | Antracit mat / Matt anthracite |
| EL0074876 | Bej mat / Matt beige |

ÎNTRERUPĂTOR - 2M 2M - SWITCH



| Cod / Code | Culoare / Colors |
|------------|--------------------------------|
| EL0074814 | Alb / White |
| EL0074839 | Alb mat / Matt white |
| EL0074860 | Antracit mat / Matt anthracite |
| EL0074881 | Bej mat / Matt beige |

ÎNTRERUPĂTOR CAP SCARĂ - 1M 1M - TWO WAY SWITCH



| Cod / Code | Culoare / Colors |
|------------|--------------------------------|
| EL0074812 | Alb / White |
| EL0074837 | Alb mat / Matt white |
| EL0074858 | Antracit mat / Matt anthracite |
| EL0074879 | Bej mat / Matt beige |

ÎNTRERUPĂTOR CAP SCARĂ - 2M 2M - TWO WAY SWITCH



| Cod / Code | Culoare / Colors |
|------------|--------------------------------|
| EL0074816 | Alb / White |
| EL0074841 | Alb mat / Matt white |
| EL0074862 | Antracit mat / Matt anthracite |
| EL0074883 | Bej mat / Matt beige |

ÎNTRERUPĂTOR CRUCE - 1M 1M - CROSS SWITCH



| Cod / Code | Culoare / Colors |
|------------|--------------------------------|
| EL0074813 | Alb / White |
| EL0074838 | Alb Mat / Matt white |
| EL0074859 | Antracit mat / Matt anthracite |
| EL0074880 | Bej mat / Matt beige |

ÎNTRERUPĂTOR CRUCE - 2M 2M - CROSS SWITCH



| Cod / Code | Culoare / Colors |
|------------|--------------------------------|
| EL0074817 | Alb / White |
| EL0074842 | Alb Mat / Matt white |
| EL0074863 | Antracit mat / Matt anthracite |
| EL0074884 | Bej mat / Matt beige |

MODULE / MODULE

10A 230V IP20 ST

ÎNTRERUPĂTOR REVENIRE - 1M
1M - PUSH BUTTON SWITCH



| Cod / Code | Culoare / Colors |
|------------|--------------------------------|
| EL0074811 | Alb / White |
| EL0074836 | Alb mat / Matt white |
| EL0074857 | Antracit mat / Matt anthracite |
| EL0074878 | Bej mat / Matt beige |

ÎNTRERUPĂTOR REVENIRE - 2M
2M - PUSH BUTTON SWITCH



| Cod / Code | Culoare / Colors |
|------------|--------------------------------|
| EL0074815 | Alb / White |
| EL0074840 | Alb mat / Matt white |
| EL0074861 | Antracit mat / Matt anthracite |
| EL0074882 | Bej mat / Matt beige |

ÎNTRERUPĂTOR CU LED - 1M
1M - SWITCH WITH LED



| Cod / Code | Culoare / Colors |
|------------|--------------------------------|
| EL0074810 | Alb / White |
| EL0074835 | Alb mat / Matt white |
| EL0074856 | Antracit mat / Matt anthracite |
| EL0074877 | Bej mat / Matt beige |

ÎNTRERUPĂTOR JALUZELE - 1M
1M - BLIND SWITCH



| Cod / Code | Culoare / Colors |
|------------|--------------------------------|
| EL0074808 | Alb / White |
| EL0074833 | Alb mat / Matt white |
| EL0074854 | Antracit mat / Matt anthracite |
| EL0074875 | Bej mat / Matt beige |

PRIZĂ TV MUFĂ F - 1M
1M - TV SOCKET F TYPE



| Cod / Code | Culoare / Colors |
|------------|--------------------------------|
| EL0074820 | Alb / White |
| EL0074845 | Alb mat / Matt white |
| EL0074866 | Antracit mat / Matt anthracite |
| EL0074887 | Bej mat / Matt beige |

TASTĂ FALSĂ - 1M
1M - BLIND COVER



| Cod / Code | Culoare / Colors |
|------------|--------------------------------|
| EL0074828 | Alb / White |
| EL0074853 | Alb mat / Matt white |
| EL0074874 | Antracit mat / Matt anthracite |
| EL0074895 | Bej mat / Matt beige |

MODULE / MODULE

10A 230V IP20 ST

PRIZĂ SCHUKO CU CAPAC CU PROTECȚIE COPII - 2M
2M - SCHUKO SOCKET WITH CHILD PROTECTION AND COVER

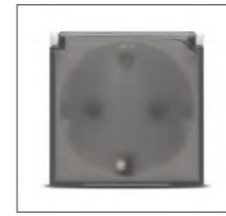

| Cod / Code | Culoare / Colors |
|------------|--------------------------------|
| EL0074822 | Alb / White |
| EL0074847 | Alb mat / Matt white |
| EL0074868 | Antracit mat / Matt anthracite |
| EL0074889 | Bej mat / Matt beige |

PRIZĂ SCHUKO CU PROTECȚIE COPII - 2M
2M - SCHUKO SOCKET WITH CHILD PROTECTION



| Cod / Code | Culoare / Colors |
|------------|--------------------------------|
| EL0074821 | Alb / White |
| EL0074846 | Alb mat / Matt white |
| EL0074867 | Antracit mat / Matt anthracite |
| EL0074888 | Bej mat / Matt beige |

PRIZĂ SCHUKO CU PROTECȚIE COPII - 2M
2M - SCHUKO SOCKET WITH CHILD PROTECTION



| Cod / Code | Culoare / Colors |
|------------|------------------|
| EL0075024 | Roșu / Red |

PRIZĂ - 1M
1M - SOCKET



| Cod / Code | Culoare / Colors |
|------------|--------------------------------|
| EL0074818 | Alb / White |
| EL0074843 | Alb mat / Matt white |
| EL0074864 | Antracit mat / Matt anthracite |
| EL0074885 | Bej mat / Matt beige |

PRIZĂ USB A+C 5V 2,4A - 2M
2M - USB SOCKET (TYPE C+A) 5V 2,4A



| Cod / Code | Culoare / Colors |
|------------|--------------------------------|
| EL0074823 | Alb / White |
| EL0074848 | Alb mat / Matt white |
| EL0074869 | Antracit mat / Matt anthracite |
| EL0074890 | Bej mat / Matt beige |

PRIZĂ UTP CAT6E - 1M
1M - CAT 6E UTP SOCKET



| Cod / Code | Culoare / Colors |
|------------|--------------------------------|
| EL0074819 | Alb / White |
| EL0074844 | Alb mat / Matt white |
| EL0074865 | Antracit mat / Matt anthracite |
| EL0074886 | Bej mat / Matt beige |

RAME / FRAMES

IP20

ALB / WHITE



| Cod / Code | Nr. module/ Module No. |
|------------|------------------------|
| EL0078275 | 1M |
| EL0074824 | 2M |
| EL0078281 | 2M |
| EL0074825 | 3M |
| EL0074826 | 4M |
| EL0074827 | 7M |

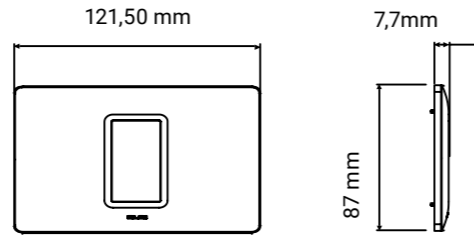

ALB MAT / MATT WHITE

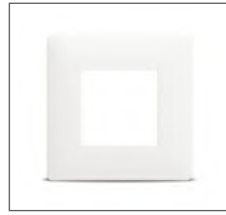

| Cod / Code | Nr. module/ Module No. |
|------------|------------------------|
| EL0078282 | 1M |
| EL0074849 | 2M |
| EL0078283 | 2M |
| EL0074850 | 3M |
| EL0074851 | 4M |
| EL0074852 | 7M |

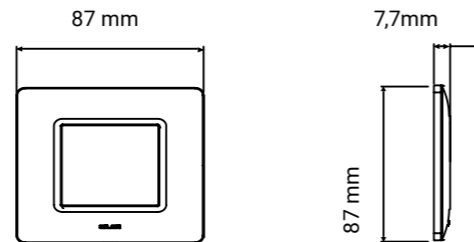

BEJ MAT / MATT BEIGE



| Cod / Code | Nr. module/ Module No. |
|------------|------------------------|
| EL0078284 | 1M |
| EL0074891 | 2M |
| EL0078285 | 2M |
| EL0074892 | 3M |
| EL0074893 | 4M |
| EL0074894 | 7M |

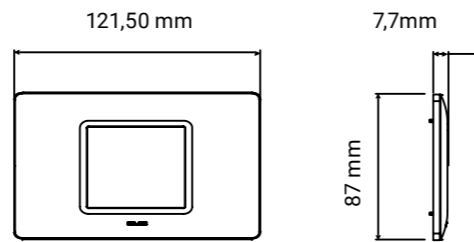

ANTRACIT MAT / MATT ANTHRACITE



| Cod / Code | Nr. module/ Module No. |
|------------|------------------------|
| EL0078286 | 1M |
| EL0074870 | 2M |
| EL0078287 | 2M |
| EL0074871 | 3M |
| EL0074872 | 4M |
| EL0074873 | 7M |

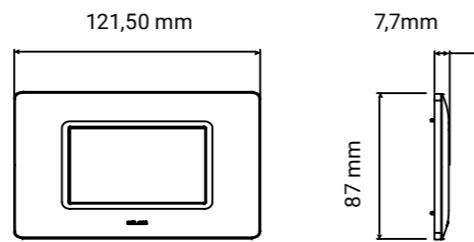

SUPORT / SUPPORT



| Cod / Code | Nr. module/ Module No. |
|------------|------------------------|
| EL0074829 | 2M |
| EL0078288 | 2M |
| EL0074830 | 3M |
| EL0074831 | 4M |
| EL0074832 | 7M |

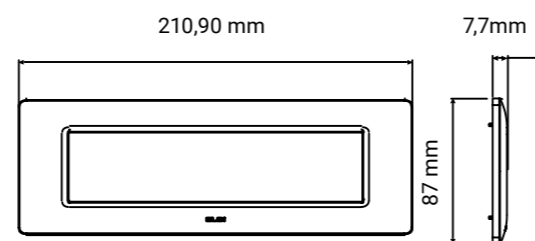
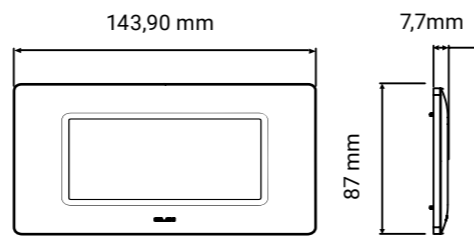

CORPURI DE ILLUMINAT DECORATIVE
SURSE
SMART HOME
APARATAJ
CONECTICA
PROTECTII
CORPURI DE ILLUMINAT TEHNICE
TRASEE
CABLURI



GAMA DE APARATAJ JAZZ

JAZZ PRODUCT RANGE

RO

Gama de aparataj Jazz cu standard german/ doză rotundă combină designul cu fiabilitatea. Caracterizată printr-o estetică modernă și funcționalitate avansată, această gamă oferă soluții versatile, asigurând durabilitate și ușurință în utilizare. Ideală pentru orice tip de interior, se integrează perfect în decoruri contemporane și clasice.

REPERE

- **Compatibilitate** - se potrivește în doze standard germane, asigurând montaj ușor;
- **Montaj flexibil** - se poate monta cu gheare sau, de preferat, cu șuruburi pentru o fixare mai sigură;
- **Durabilitate** - materiale de calitate, rezistente și durabile pentru utilizare pe termen lung.

EN

The Jazz range of German standard/ round-dosed switchgear combines design with reliability. Characterized by modern aesthetics and advanced functionality, this range offers versatile solutions, ensuring durability and ease of use. Ideal for any type of interior, it blends seamlessly into contemporary and classic decors.

FEATURES

- **Compatibility** - fits standard German boxes for easy installation;
- **Flexible installation** - can be mounted with claws or, preferably, with screws for a more secure fix;
- **Durability** - high-quality, durable materials for long-term use.



ÎNTRERUPĂTOR SIMPLU SINGLE SWITCH



| Cod / Code | Culoare / Colors |
|------------|---------------------------------|
| EL0072886 | Alb mat / Matt white |
| EL0072828 | Alb / White |
| EL0072926 | Antracit / Anthracite |
| EL0072848 | Cireș / Cherry |
| EL0072906 | Negru mat / Matt black |
| EL0072867 | Nuc închis / Dark walnut |
| EL0072946 | Titan / Titanium |

ÎNTRERUPĂTOR TRIPLU TRIPLE SWITCH



| Cod / Code | Culoare / Colors |
|------------|---------------------------------|
| EL0072885 | Alb mat / Matt white |
| EL0072827 | Alb / White |
| EL0072925 | Antracit / Anthracite |
| EL0072847 | Cireș / Cherry |
| EL0072905 | Negru mat / Matt black |
| EL0072866 | Nuc închis / Dark walnut |
| EL0072945 | Titan / Titanium |

ÎNTRERUPĂTOR CAP-SCARĂ TWO WAY SWITCH



| Cod / Code | Culoare / Colors |
|------------|---------------------------------|
| EL0072883 | Alb mat / Matt white |
| EL0072825 | Alb / White |
| EL0072923 | Antracit / Anthracite |
| EL0072845 | Cireș / Cherry |
| EL0072903 | Negru mat / Matt black |
| EL0072864 | Nuc închis / Dark walnut |
| EL0072943 | Titan / Titanium |

ÎNTRERUPĂTOR DUBLU DOUBLE SWITCH



| Cod / Code | Culoare / Colors |
|------------|---------------------------------|
| EL0072881 | Alb mat / Matt white |
| EL0072823 | Alb / White |
| EL0072921 | Antracit / Anthracite |
| EL0072843 | Cireș / Cherry |
| EL0072901 | Negru mat / Matt black |
| EL0072862 | Nuc închis / Dark walnut |
| EL0072941 | Titan / Titanium |

ÎNTRERUPĂTOR CRUCE CROSS SWITCH



| Cod / Code | Culoare / Colors |
|------------|---------------------------------|
| EL0072882 | Alb mat / Matt white |
| EL0072824 | Alb / White |
| EL0072922 | Antracit / Anthracite |
| EL0072844 | Cireș / Cherry |
| EL0072902 | Negru mat / Matt black |
| EL0072863 | Nuc închis / Dark walnut |
| EL0072942 | Titan / Titanium |

ÎNTRERUPĂTOR DUBLU CAP-SCARĂ DOUBLE TWO WAY SWITCH



| Cod / Code | Culoare / Colors |
|------------|---------------------------------|
| EL0072880 | Alb mat / Matt white |
| EL0072822 | Alb / White |
| EL0072920 | Antracit / Anthracite |
| EL0072842 | Cireș / Cherry |
| EL0072900 | Negru mat / Matt black |
| EL0072861 | Nuc închis / Dark walnut |
| EL0072940 | Titan / Titanium |



ÎNTRERUPĂTOR SONERIE
BELL SWITCH



| Cod / Code | Culoare / Colors |
|------------|--------------------------|
| EL0072884 | Alb mat / Matt white |
| EL0072826 | Alb / White |
| EL0072924 | Antracit / Anthracite |
| EL0072846 | Cireș / Cherry |
| EL0072904 | Negru mat / Matt black |
| EL0072865 | Nuc închis / Dark walnut |
| EL0072944 | Titan / Titanium |

PRIZĂ UTP CAT 6E
CAT 6E UTP SOCKET



| Cod / Code | Culoare / Colors |
|------------|--------------------------|
| EL0072894 | Alb mat / Matt white |
| EL0072836 | Alb / White |
| EL0072934 | Antracit / Anthracite |
| EL0072856 | Cireș / Cherry |
| EL0072914 | Negru mat / Matt black |
| EL0072875 | Nuc închis / Dark walnut |
| EL0072954 | Titan / Titanium |

PRIZĂ TV CONECTOR F
TV SOCKET „F” TYPE



| Cod / Code | Culoare / Colors |
|------------|--------------------------|
| EL0072893 | Alb mat / Matt white |
| EL0072835 | Alb / White |
| EL0072933 | Antracit / Anthracite |
| EL0072855 | Cireș / Cherry |
| EL0072913 | Negru mat / Matt black |
| EL0072874 | Nuc închis / Dark walnut |
| EL0072953 | Titan / Titanium |

PRIZĂ DUBLĂ UTP CAT 6E
CAT 6E UTP DOUBLE SOCKET



| Cod / Code | Culoare / Colors |
|------------|------------------------|
| EL0072895 | Alb mat / Matt white |
| EL0072837 | Alb / White |
| EL0072935 | Antracit / Anthracite |
| EL0072915 | Negru mat / Matt black |
| EL0072955 | Titan / Titanium |



PRIZĂ SIMPLĂ FĂRĂ ÎMPĂMÂNTARE
SINGLE SOCKET NON-EARTHED

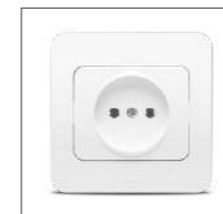

| Cod / Code | Culoare / Colors |
|------------|--------------------------|
| EL0072892 | Alb mat / Matt white |
| EL0072834 | Alb / White |
| EL0072932 | Antracit / Anthracite |
| EL0072854 | Cireș / Cherry |
| EL0072912 | Negru mat / Matt black |
| EL0072873 | Nuc închis / Dark walnut |
| EL0072952 | Titan / Titanium |

PRIZĂ SCHUKO
SCHUKO SOCKET



| Cod / Code | Culoare / Colors |
|------------|--------------------------|
| EL0072889 | Alb mat / Matt white |
| EL0072831 | Alb / White |
| EL0072929 | Antracit / Anthracite |
| EL0072851 | Cireș / Cherry |
| EL0072909 | Negru mat / Matt black |
| EL0072870 | Nuc închis / Dark walnut |
| EL0072949 | Titan / Titanium |

PRIZĂ SCHUKO CU CAPAC
SCHUKO SOCKET WITH COVER



| Cod / Code | Culoare / Colors |
|------------|--------------------------|
| EL0072887 | Alb mat / Matt white |
| EL0072829 | Alb / White |
| EL0072927 | Antracit / Anthracite |
| EL0072849 | Cireș / Cherry |
| EL0072907 | Negru mat / Matt black |
| EL0072868 | Nuc închis / Dark walnut |
| EL0072947 | Titan / Titanium |

PRIZĂ DUBLĂ FĂRĂ ÎMPĂMÂNTARE
DOUBLE SOCKET NON-EARTHED



| Cod / Code | Culoare / Colors |
|------------|--------------------------|
| EL0072891 | Alb mat / Matt white |
| EL0072833 | Alb / White |
| EL0072931 | Antracit / Anthracite |
| EL0072853 | Cireș / Cherry |
| EL0072911 | Negru mat / Matt black |
| EL0072872 | Nuc închis / Dark walnut |
| EL0072951 | Titan / Titanium |

PRIZĂ SCHUKO DUBLĂ
DOUBLE SCHUKO SOCKET



| Cod / Code | Culoare / Colors |
|------------|--------------------------|
| EL0072890 | Alb mat / Matt white |
| EL0072832 | Alb / White |
| EL0072930 | Antracit / Anthracite |
| EL0072852 | Cireș / Cherry |
| EL0072910 | Negru mat / Matt black |
| EL0072871 | Nuc închis / Dark walnut |
| EL0072950 | Titan / Titanium |

PRIZĂ SCHUKO CU PROTECȚIE COPII
SCHUKO SOCKET WITH CHILD PROTECTION



| Cod / Code | Culoare / Colors |
|------------|--------------------------|
| EL0072888 | Alb mat / Matt white |
| EL0072830 | Alb / White |
| EL0072928 | Antracit / Anthracite |
| EL0072850 | Cireș / Cherry |
| EL0072908 | Negru mat / Matt black |
| EL0072869 | Nuc închis / Dark walnut |
| EL0072948 | Titan / Titanium |

PANOURI - RAME / PANELS - FRAMES

IP20

RAMĂ 2P
2P FRAME



| Cod / Code | Culoare / Colors |
|------------|---------------------------------|
| EL0072896 | Alb mat / Matt white |
| EL0072838 | Alb / White |
| EL0072936 | Antracit / Anthracite |
| EL0072857 | Cireș / Cherry |
| EL0072916 | Negru mat / Matt black |
| EL0072876 | Nuc închis / Dark walnut |
| EL0072956 | Titan / Titanium |

RAMĂ 3P
3P FRAME



| Cod / Code | Culoare / Colors |
|------------|---------------------------------|
| EL0072897 | Alb mat / Matt white |
| EL0072839 | Alb / White |
| EL0072937 | Antracit / Anthracite |
| EL0072858 | Cireș / Cherry |
| EL0072917 | Negru mat / Matt black |
| EL0072877 | Nuc închis / Dark walnut |
| EL0072957 | Titan / Titanium |

RAMĂ 4P
4P FRAME

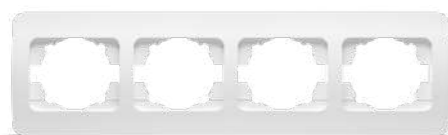

| Cod / Code | Culoare / Colors |
|------------|---------------------------------|
| EL0072898 | Alb mat / Matt white |
| EL0072840 | Alb / White |
| EL0072938 | Antracit / Anthracite |
| EL0072859 | Cireș / Cherry |
| EL0072918 | Negru mat / Matt black |
| EL0072878 | Nuc închis / Dark walnut |
| EL0072958 | Titan / Titanium |

RAMĂ 5P
5P FRAME



| Cod / Code | Culoare / Colors |
|------------|---------------------------------|
| EL0072899 | Alb mat / Matt white |
| EL0072841 | Alb / White |
| EL0072939 | Antracit / Anthracite |
| EL0072860 | Cireș / Cherry |
| EL0072919 | Negru mat / Matt black |
| EL0072879 | Nuc închis / Dark walnut |
| EL0072959 | Titan / Titanium |

ELBI
ELECTRIC



jazz
turn on the life



Ramele se pot utiliza doar pe orizontală.
The frames can only be used horizontally.



GAMA DE APARATAJ ZENA

ZENA PRODUCT RANGE

RO

Gama de aparataj Zena cu standard german și doză rotundă aduce un echilibru perfect între design și fiabilitate. Cu un aspect modern și o funcționalitate remarcabilă, această gamă oferă soluții adaptabile pentru diverse nevoi, garantând durabilitate și ușurință în utilizare. Potrivită pentru orice tip de interior, Zena se potrivește perfect în decoruri atât contemporane, cât și clasice.

REPERE

- **Compatibilitate** - se potrivește în doze standard germane, asigurând montaj ușor;
- **Design cu colțuri drepte** - design modern cu colțuri drepte, montaj cu gheare sau, de preferat, cu șuruburi pentru o fixare mai sigură;
- **Durabilitate** - materiale de calitate, rezistente pentru utilizare pe termen lung.

EN

The Zena range of electrical devices, featuring a German standard and round box, strikes the perfect balance between design and reliability. With a modern look and remarkable functionality, this range offers adaptable solutions for various needs, ensuring durability and ease of use. Suitable for any type of interior, Zena blends seamlessly into both contemporary and classic decor.

FEATURES

- **Compatibility** - fits standard German boxes for easy installation;
- **Straight-edge design** - features straight edges for a clean, modern look and can be mounted with claws or, preferably, with screws for a more secure fit;
- **Durability** - high-quality, durable materials for long-term use.



ÎNTRERUPĂTOR SIMPLU SINGLE SWITCH



| Cod / Code | Culoare / Colors |
|------------|--------------------------------------|
| EL0072966 | Alb mat / Matt white |
| EL0011922 | Alb / White |
| EL0013520 | Arțar / Maple |
| EL0012149 | Cireș / Cherry |
| EL0017781 | Fildeș / Ivory |
| EL0011998 | Fume / Smoke |
| EL0011965 | Gri metalizat / Metallic gray |
| EL0012449 | Mahon / Mahogany |
| EL0070976 | Negru mat / Matt black |
| EL0012061 | Titan / Titanium |
| EL0012389 | Crem / Cream |

ÎNTRERUPĂTOR SIMPLU CU LED SINGLE SWITCH WITH LED



| Cod / Code | Culoare / Colors |
|------------|--------------------------------------|
| EL0011923 | Alb / White |
| EL0012421 | Cireș / Cherry |
| EL0012001 | Gri metalizat / Metallic gray |
| EL0012450 | Mahon / Mahogany |

ÎNTRERUPĂTOR TRIPLU TRIPLE SWITCH



| Cod / Code | Culoare / Colors |
|------------|-------------------------------|
| EL0072965 | Alb mat / Matt white |
| EL0011942 | Alb / White |
| EL0012443 | Cireș / Cherry |
| EL0012472 | Mahon / Mahogany |
| EL0070982 | Negru mat / Matt black |

ÎNTRERUPĂTOR DUBLU DOUBLE SWITCH



| Cod / Code | Culoare / Colors |
|------------|--------------------------------------|
| EL0072961 | Alb mat / Matt white |
| EL0011924 | Alb / White |
| EL0013556 | Arțar / Maple |
| EL0012422 | Cireș / Cherry |
| EL0017783 | Fildeș / Ivory |
| EL0011999 | Fume / Smoke |
| EL0012002 | Gri metalizat / Metallic gray |
| EL0012151 | Mahon / Mahogany |
| EL0070977 | Negru mat / Matt black |
| EL0012152 | Titan / Titanium |
| EL0012391 | Crem / Cream |

ÎNTRERUPĂTOR DUBLU CU LED DOUBLE SWITCH WITH LED



| Cod / Code | Culoare / Colors |
|------------|--------------------------------------|
| EL0011925 | Alb / White |
| EL0012423 | Cireș / Cherry |
| EL0012003 | Gri metalizat / Metallic gray |
| EL0012451 | Mahon / Mahogany |

ÎNTRERUPĂTOR CAP SCARĂ CU LED TWO WAY SWITCH WITH LED



| Cod / Code | Culoare / Colors |
|------------|--------------------|
| EL0011930 | Alb / White |



ÎNTRERUPĂTOR CAP SCARĂ
TWO WAY SWITCH



| Cod / Code | Culoare / Colors |
|------------|--------------------------------------|
| EL0072963 | Alb mat / Matt white |
| EL0011929 | Alb / White |
| EL0013560 | Arțar / Maple |
| EL0011958 | Cireș / Cherry |
| EL0017786 | Fildeș / Ivory |
| EL0011987 | Fume / Smoke |
| EL0011991 | Gri metalizat / Metallic gray |
| EL0012457 | Mahon / Mahogany |
| EL0070978 | Negru mat / Matt black |
| EL0011956 | Titan / Titanium |
| EL0012395 | Crem / Cream |

ÎNTRERUPĂTOR CRUCE
CROSS SWITCH



| Cod / Code | Culoare / Colors |
|------------|--------------------------------------|
| EL0072962 | Alb mat / Matt white |
| EL0011995 | Alb / White |
| EL0012430 | Cireș / Cherry |
| EL0017788 | Fildeș / Ivory |
| EL0012008 | Fume / Smoke |
| EL0011981 | Gri metalizat / Metallic gray |
| EL0012460 | Mahon / Mahogany |
| EL0070979 | Negru mat / Matt black |
| EL0012240 | Titan / Titanium |

ÎNTRERUPĂTOR CAP SCARĂ DUBLU
DOUBLE TWO WAY SWITCH



| Cod / Code | Culoare / Colors |
|------------|--------------------------------------|
| EL0072960 | Alb mat / Matt white |
| EL0011931 | Alb / White |
| EL0012429 | Cireș / Cherry |
| EL0011975 | Fume / Smoke |
| EL0012019 | Gri metalizat / Metallic gray |
| EL0012459 | Mahon / Mahogany |
| EL0070980 | Negru mat / Matt black |
| EL0012239 | Titan / Titanium |

ÎNTRERUPĂTOR SONERIE
DOOR BELL SWITCH



| Cod / Code | Culoare / Colors |
|------------|--------------------------------------|
| EL0072964 | Alb mat / Matt white |
| EL0011927 | Alb / White |
| EL0011957 | Cireș / Cherry |
| EL0011971 | Fume / Smoke |
| EL0011947 | Gri metalizat / Metallic gray |
| EL0012455 | Mahon / Mahogany |
| EL0070981 | Negru mat / Matt black |
| EL0011954 | Titan / Titanium |



PRIZĂ SIMPLĂ FĂRĂ ÎMPĂMÂNTARE
SINGLE SOCKET NON-EARTHED



| Cod / Code | Culoare / Colors |
|------------|--------------------------------------|
| EL0072972 | Alb mat / Matt white |
| EL0011932 | Alb / White |
| EL0012431 | Cireș / Cherry |
| EL0011952 | Fume / Smoke |
| EL0011948 | Gri metalizat / Metallic gray |
| EL0012461 | Mahon / Mahogany |
| EL0070985 | Negru mat / Matt black |

PRIZĂ DUBLĂ FĂRĂ ÎMPĂMÂNTARE
DOUBLE SOCKET NON-EARTHED



| Cod / Code | Culoare / Colors |
|------------|--------------------------------------|
| EL0072971 | Alb mat / Matt white |
| EL0012006 | Alb / White |
| EL0012448 | Cireș / Cherry |
| EL0012021 | Fume / Smoke |
| EL0011994 | Gri metalizat / Metallic gray |
| EL0012477 | Mahon / Mahogany |
| EL0070986 | Negru mat / Matt black |

PRIZĂ SCHUKO
SCHUKO SOCKET



| Cod / Code | Culoare / Colors |
|------------|--------------------------------------|
| EL0072969 | Alb mat / Matt white |
| EL0011933 | Alb / White |
| EL0013524 | Arțar / Maple |
| EL0012432 | Cireș / Cherry |
| EL0017790 | Fildeș / Ivory |
| EL0012000 | Fume / Smoke |
| EL0012004 | Gri metalizat / Metallic gray |
| EL0011959 | Mahon / Mahogany |
| EL0070983 | Negru mat / Matt black |
| EL0012037 | Titan / Titanium |
| EL0012398 | Crem / Cream |

PRIZĂ SCHUKO DUBLĂ
SCHUKO DOUBLE SOCKET



| Cod / Code | Culoare / Colors |
|------------|--------------------------------------|
| EL0072970 | Alb mat / Matt white |
| EL0011946 | Alb / White |
| EL0013576 | Arțar / Maple |
| EL0012447 | Cireș / Cherry |
| EL0017801 | Fildeș / Ivory |
| EL0012022 | Fume / Smoke |
| EL0012005 | Gri metalizat / Metallic gray |
| EL0012476 | Mahon / Mahogany |
| EL0070984 | Negru mat / Matt black |
| EL0012073 | Titan / Titanium |
| EL0012406 | Crem / Cream |



PRIZĂ SCHUKO CU PROTECȚIE PENTRU COPII
SCHUKO SOCKET WITH CHILD PROTECTION



| Cod / Code | Culoare / Colors |
|------------|------------------------|
| EL0072968 | Alb mat / Matt white |
| EL0011941 | Alb / White |
| EL0012442 | Cireș / Cherry |
| EL0012471 | Mahon / Mahogany |
| EL0070988 | Negru mat / Matt black |

PRIZĂ SCHUKO CU CAPAC
SCHUKO SOCKET WITH COVER



| Cod / Code | Culoare / Colors |
|------------|-------------------------------|
| EL0072967 | Alb mat / Matt white |
| EL0011934 | Alb / White |
| EL0012433 | Cireș / Cherry |
| EL0011950 | Gri metalizat / Metallic gray |
| EL0011960 | Mahon / Mahogany |
| EL0070987 | Negru mat / Matt black |
| EL0013869 | Crem / Cream |
| EL0011976 | Fume / Smoke |

PRIZĂ TV DE CAPĂȚ ECRANATĂ
END TV SOCKET



| Cod / Code | Culoare / Colors |
|------------|------------------|
| EL0014876 | Alb / White |

PRIZĂ UTP CAT 6E
CAT 6E UTP SOCKET



| Cod / Code | Culoare / Colors |
|------------|-------------------------------|
| EL0072974 | Alb mat / Matt white |
| EL0018811 | Alb / White |
| EL0018794 | Cireș / Cherry |
| EL0018635 | Gri metalizat / Metallic gray |
| EL0018655 | Mahon / Mahogany |
| EL0070990 | Negru mat / Matt black |
| EL0018865 | Titan / Titanium |



PRIZĂ TV INTERMEDIARĂ ECRANATĂ
INTERMEDIATE TV SOCKET



| Cod / Code | Culoare / Colors |
|------------|-------------------------------|
| EL0011943 | Alb / White |
| EL0012444 | Cireș / Cherry |
| EL0012016 | Fume / Smoke |
| EL0011985 | Gri metalizat / Metallic gray |
| EL0012473 | Mahon / Mahogany |
| EL0012070 | Titan / Titanium |

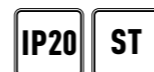

PRIZĂ TV CONECTOR F
TV SOCKET „F” TYPE



| Cod / Code | Culoare / Colors |
|------------|------------------------|
| EL0072973 | Alb mat / Matt white |
| EL0011944 | Alb / White |
| EL0012445 | Cireș / Cherry |
| EL0012474 | Mahon / Mahogany |
| EL0070989 | Negru mat / Matt black |

PRIZĂ DUBLĂ UTP 6E
UTP 6E DOUBLE SOCKET



| Cod / Code | Culoare / Colors |
|------------|------------------|
| EL0017985 | Alb / White |
| EL0018797 | Cireș / Cherry |

RAMĂ 2P
2P FRAME



| Cod / Code | Culoare / Colors |
|------------|--------------------------------------|
| EL0072975 | Alb mat / Matt white |
| EL0011937 | Alb / White |
| EL0012436 | Cireș / Cherry |
| EL0012020 | Fume / Smoke |
| EL0011993 | Gri metalizat / Metallic gray |
| EL0012465 | Mahon / Mahogany |
| EL0070991 | Negru mat / Matt black |
| EL0012066 | Titan / Titanium |

RAMĂ 3P
3P FRAME



| Cod / Code | Culoare / Colors |
|------------|--------------------------------------|
| EL0072976 | Alb mat / Matt white |
| EL0011938 | Alb / White |
| EL0012437 | Cireș / Cherry |
| EL0012011 | Fume / Smoke |
| EL0011989 | Gri metalizat / Metallic gray |
| EL0012466 | Mahon / Mahogany |
| EL0070992 | Negru mat / Matt black |
| EL0012067 | Titan / Titanium |

RAMĂ 4P
4P FRAME



| Cod / Code | Culoare / Colors |
|------------|--------------------------------------|
| EL0072977 | Alb mat / Matt white |
| EL0011939 | Alb / White |
| EL0012438 | Cireș / Cherry |
| EL0012012 | Fume / Smoke |
| EL0011982 | Gri metalizat / Metallic gray |
| EL0012467 | Mahon / Mahogany |
| EL0070993 | Negru mat / Matt black |
| EL0012068 | Titan / Titanium |

RAMĂ 5P
5P FRAME

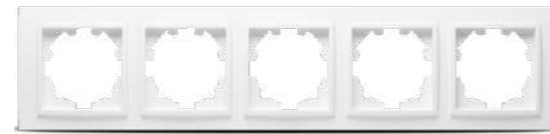

| Cod / Code | Culoare / Colors |
|------------|--------------------------------------|
| EL0072978 | Alb mat / Matt White |
| EL0013220 | Alb / White |
| EL0013273 | Cireș / Cherry |
| EL0013266 | Gri metalizat / Metallic gray |
| EL0013280 | Mahon / Mahogany |
| EL0070994 | Negru mat / Matt black |

10A 230V IP20 ST

MECANISME / MECHANISMS

ÎNTRERUPĂTOR SIMPLU
SINGLE SWITCH

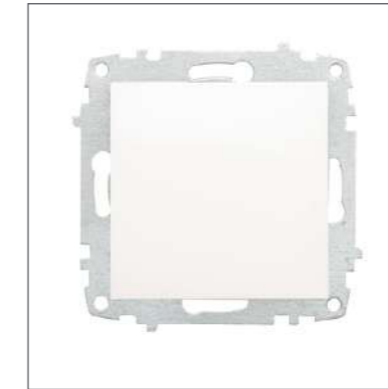

Cod / Code
EL0014839

ÎNTRERUPĂTOR DUBLU
DOUBLE SWITCH

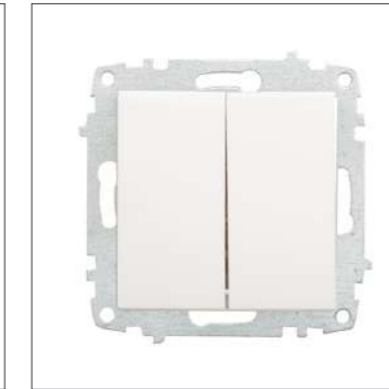

Cod / Code
EL0014841

ÎNTRERUPĂTOR CAP-SCARĂ
TWO WAY SWITCH



Cod / Code
EL0014848

ÎNTRERUPĂTOR CRUCE
SWITCH CROSS



Cod / Code
EL0014851

PRIZĂ SCHUKO 16A
16A SCHUKO SOCKET



Cod / Code
EL0014854



GAMA DE APARATAJ ZIRVE

ZIRVE PRODUCT RANGE

RO

Gama de aparataj Zirve cu standard german și doză rotundă îmbină armonios estetica modernă cu fiabilitatea superioară. Proiectată pentru a oferi soluții versatile și ușor de utilizat, această gamă asigură durabilitate și performanță excelentă. Ideală pentru diverse tipuri de interioare, Zirve se integrează cu ușurință în decoruri contemporane și clasice, aducând un plus de eleganță și funcționalitate.

REPERE

- **Design modern** - colțuri rotunde pentru un aspect elegant și contemporan;
- **Siguranță** - formă optimizată pentru a reduce riscul de accidente și pentru o utilizare ușoară.
- **Montaj flexibil** - se pot monta cu gheare sau șuruburi, oferind o fixare sigură și ușurință în instalare.

EN

The Zirve range of electrical devices, featuring a German standard and round box, seamlessly combines modern aesthetics with superior reliability. Designed to provide versatile and user-friendly solutions, this range ensures durability and excellent performance. Ideal for various types of interiors, Zirve integrates effortlessly into both contemporary and classic decor, adding a touch of elegance and functionality.

FEATURES

- **Modern design** - rounded corners for an elegant and contemporary look;
- **Safety** - optimized shape to reduce the risk of accidents and ensure easy use;
- **Flexible installation** - can be mounted with claws or screws, providing secure fixation and easy installation.



ÎNTRERUPĂTOR SIMPLU SINGLE SWITCH



| Cod / Code | Culoare / Colors |
|------------|--------------------------|
| EL0000039 | Alb / White |
| EL0000201 | Cireș / Cherry |
| EL0000139 | Nuc închis / Dark walnut |
| EL0000258 | Stejar / Oak |

ÎNTRERUPĂTOR SIMPLU CU LED SINGLE SWITCH WITH LED



| Cod / Code | Culoare / Colors |
|------------|--------------------------|
| EL0000040 | Alb / White |
| EL0000202 | Cireș / Cherry |
| EL0000140 | Nuc închis / Dark walnut |
| EL0000259 | Stejar / Oak |

ÎNTRERUPĂTOR CAP-SCARĂ TWO WAY SWITCH



| Cod / Code | Culoare / Colors |
|------------|--------------------------|
| EL0000047 | Alb / White |
| EL0000210 | Cireș / Cherry |
| EL0000148 | Nuc închis / Dark walnut |
| EL0000267 | Stejar / Oak |

ÎNTRERUPĂTOR TRIPLU TRIPLE SWITCH



| Cod / Code | Culoare / Colors |
|------------|------------------|
| EL0006813 | Alb / White |

ÎNTRERUPĂTOR DUBLU DOUBLE SWITCH



| Cod / Code | Culoare / Colors |
|------------|--------------------------|
| EL0000041 | Alb / White |
| EL0000203 | Cireș / Cherry |
| EL0000141 | Nuc închis / Dark walnut |
| EL0000260 | Stejar / Oak |

ÎNTRERUPĂTOR DUBLU CU LED DOUBLE SWITCH WITH LED



| Cod / Code | Culoare / Colors |
|------------|--------------------------|
| EL0000042 | Alb / White |
| EL0000204 | Cireș / Cherry |
| EL0000142 | Nuc închis / Dark walnut |
| EL0000261 | Stejar / Oak |

ÎNTRERUPĂTOR DUBLU CAP-SCARĂ TWO WAY DOUBLE SWITCH



| Cod / Code | Culoare / Colors |
|------------|--------------------------|
| EL0000049 | Alb / White |
| EL0000212 | Cireș / Cherry |
| EL0000150 | Nuc închis / Dark walnut |
| EL0000269 | Stejar / Oak |

ÎNTRERUPĂTOR CAP-SCARĂ CU LED TWO WAY SWITCH WITH LED



| Cod / Code | Culoare / Colors |
|------------|------------------|
| EL0000048 | Alb / White |



ÎNTRERUPĂTOR SONERIE
DOOR BELL SWITCH



| Cod / Code | Culoare / Colors |
|------------|--------------------------|
| EL0000045 | Alb / White |
| EL0000208 | Cireș / Cherry |
| EL0000146 | Nuc închis / Dark walnut |
| EL0000265 | Stejar / Oak |

ÎNTRERUPĂTOR CRUCE
CROSS SWITCH



| Cod / Code | Culoare / Colors |
|------------|--------------------------|
| EL0003180 | Alb / White |
| EL0000213 | Cireș / Cherry |
| EL0000151 | Nuc închis / Dark walnut |
| EL0000270 | Stejar / Oak |



PRIZĂ UTP CAT 6E
CAT 6E UTP SOCKET



| Cod / Code | Culoare / Colors |
|------------|--------------------------|
| EL0017071 | Alb / White |
| EL0017279 | Cireș / Cherry |
| EL0017278 | Nuc închis / Dark walnut |

PRIZĂ DUBLĂ UTP CAT 6E
CAT 6E UTP DOUBLE SOCKET



| Cod / Code | Culoare / Colors |
|------------|------------------|
| EL0017073 | Alb / White |



PRIZĂ TV CONECTOR F
TV SOCKET „F” TYPE



| Cod / Code | Culoare / Colors |
|------------|--------------------------|
| EL0011663 | Alb / White |
| EL0017839 | Nuc închis / Dark walnut |

PRIZĂ TV INTERMEDIARĂ
INTERMEDIATE TV SOCKET



| Cod / Code | Culoare / Colors |
|------------|--------------------------|
| EL0000064 | Alb / White |
| EL0000226 | Cireș / Cherry |
| EL0000164 | Nuc închis / Dark walnut |
| EL0000283 | Stejar / Oak |

PRIZĂ SIMPLĂ FĂRĂ ÎMPĂMÂNTARE
SINGLE SOCKET NON-EARTHED



| Cod / Code | Culoare / Colors |
|------------|--------------------------|
| EL0000054 | Alb / White |
| EL0000216 | Cireș / Cherry |
| EL0000154 | Nuc închis / Dark walnut |

PRIZĂ DUBLĂ FĂRĂ ÎMPĂMÂNTARE
DOUBLE SOCKET NON-EARTHED



| Cod / Code | Culoare / Colors |
|------------|--------------------------|
| EL0000065 | Alb / White |
| EL0000227 | Cireș / Cherry |
| EL0000165 | Nuc închis / Dark walnut |

PRIZĂ TV INTERMEDIARĂ ECRANATĂ
SHIELDED INTERMEDIATE TV SOCKET



| Cod / Code | Culoare / Colors |
|------------|--------------------------|
| EL0011053 | Alb / White |
| EL0010914 | Cireș / Cherry |
| EL0011017 | Nuc închis / Dark walnut |
| EL0011306 | Stejar / Oak |

PRIZĂ TV DE CAPĂT ECRANATĂ
SHIELDED END TV SOCKET



| Cod / Code | Culoare / Colors |
|------------|------------------|
| EL0012359 | Alb / White |

PRIZĂ SCHUKO
SCHUKO SOCKET



| Cod / Code | Culoare / Colors |
|------------|------------------|
| EL0007000 | Alb / White |

PRIZĂ SCHUKO - CERAMICĂ
SCHUKO SOCKET - CERAMICS



| Cod / Code | Culoare / Colors |
|------------|--------------------------|
| EL0000055 | Alb / White |
| EL0000217 | Cireș / Cherry |
| EL0000155 | Nuc închis / Dark walnut |
| EL0000274 | Stejar / Oak |



PRIZĂ SCHUKO DUBLĂ - CERAMICĂ
SCHUKO DOUBLE SOCKET - CERAMICS



| Cod / Code | Culoare / Colors |
|------------|--------------------------|
| EL0000066 | Alb / White |
| EL0000228 | Cireș / Cherry |
| EL0000166 | Nuc închis / Dark walnut |
| EL0000285 | Stejar / Oak |

PRIZĂ SCHUKO CU CAPAC
SCHUKO SOCKET WITH COVER



| Cod / Code | Culoare / Colors |
|------------|--------------------------|
| EL0000056 | Alb / White |
| EL0000218 | Cireș / Cherry |
| EL0000156 | Nuc închis / Dark walnut |
| EL0000275 | Stejar / Oak |

PRIZĂ SCHUKO CU PROTECȚIE COPII
SCHUKO SOCKET WITH CHILD PROTECTION



| Cod / Code | Culoare / Colors |
|------------|------------------|
| EL0003162 | Alb / White |
| EL0007109 | Stejar / Oak |

DOZA MONTAJ APARENT - ZIRVE/ZENA/
JAZZ / SURFACE MOUNTING BOX



| Cod / Code |
|------------|
| EL0003254 |

ARIPIOARE ZIRVE
FLAPS

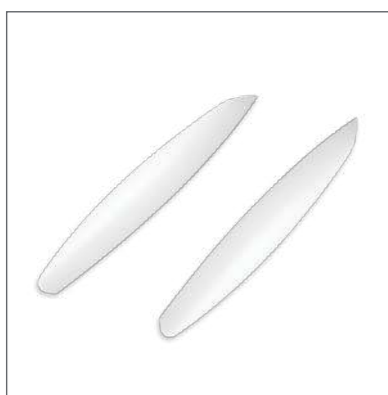

| Cod / Code |
|------------|
| EL0000718 |



i Doar modelul de culoare albă este disponibil cu această variantă.
Only the white model is available with this variant.



RAMĂ 2P
2P FRAME



| Cod / Code | Culoare / Colors | Montaj / Mounting |
|------------|--------------------------|------------------------|
| EL0000067 | Alb / White | Orizontal / Horizontal |
| EL0000229 | Cireș / Cherry | |
| EL0000167 | Nuc închis / Dark walnut | |
| EL0000286 | Stejar / Oak | |
| EL0003122 | Alb / White | Vertical / Vertical |

RAMĂ 3P
3P FRAME



| Cod / Code | Culoare / Colors | Montaj / Mounting |
|------------|--------------------------|------------------------|
| EL0000068 | Alb / White | Orizontal / Horizontal |
| EL0000230 | Cireș / Cherry | |
| EL0000168 | Nuc închis / Dark walnut | |
| EL0000287 | Stejar / Oak | Vertical / Vertical |
| EL0003123 | Alb / White | |

RAMĂ 4P
4P FRAME



| Cod / Code | Culoare / Colors | Montaj / Mounting |
|------------|--------------------------|------------------------|
| EL0000069 | Alb / White | Orizontal / Horizontal |
| EL0000231 | Cireș / Cherry | |
| EL0000169 | Nuc închis / Dark walnut | |
| EL0000288 | Stejar / Oak | |
| EL0003124 | Alb / White | Vertical / Vertical |

RAMĂ 5P
5P FRAME



| Cod / Code | Culoare / Colors | Montaj / Mounting |
|------------|--------------------------|------------------------|
| EL0002961 | Alb / White | Orizontal / Horizontal |
| EL0024981 | Cireș / Cherry | |
| EL0006586 | Nuc închis / Dark walnut | |
| EL0024982 | Stejar / Oak | Vertical / Vertical |
| EL0003125 | Alb / White | |

RAMĂ 6P
6P FRAME



| Cod / Code | Culoare / Colors | Montaj / Mounting |
|------------|------------------|---------------------|
| EL0003121 | Alb / White | Vertical / Vertical |



GAMA DE APARATAJ ALSU ALSU PRODUCT RANGE

RO

Gama ALSU de aparataj aplicat/aparent oferă soluții fiabile și moderne, ușor de instalat pe orice suprafață. Cu un design simplu și robust, este ideală pentru spații rezidențiale și comerciale, combinând funcționalitatea cu un aspect estetic plăcut.

REPERE

- **Instalare rapidă** - montajul aparent permite o instalare simplă și rapidă, fără necesitatea unor lucrări de construcție complicate;
- **Flexibilitate** - se poate monta pe orice tip de suprafață, adaptându-se ușor la diferite configurații de spațiu;
- **Estetică și funcționalitate** - designul vizibil oferă un acces ușor la dispozitivele electrice, combinând utilitatea cu un aspect modern.

EN

The ALSU range of surface-mounted electrical devices offers reliable and modern solutions, easy to install on any surface. With a simple, robust design, it is ideal for residential and commercial spaces, combining functionality with a pleasing aesthetic.

FEATURES

- **Quick installation** - surface mounting allows simple and fast installation without the need for complicated construction work;
- **Flexibility** - can be mounted on any surface, easily adapting to different space configurations;
- **Aesthetics and functionality** - the visible design provides easy access to electrical devices, combining utility with a modern look.



ÎNTRERUPĂTOR SIMPLU SINGLE SWITCH



| Cod / Code | Culoare / Colors |
|------------|--------------------------|
| EL0000447 | Alb / White |
| EL0000485 | Cireș / Cherry |
| EL0000460 | Nuc închis / Dark walnut |

ÎNTRERUPĂTOR SIMPLU CU LED SINGLE SWITCH WITH LED



| Cod / Code | Culoare / Colors |
|------------|------------------|
| EL001115 | Alb / White |

ÎNTRERUPĂTOR CAP-SCARĂ TWO WAY SWITCH



| Cod / Code | Culoare / Colors |
|------------|--------------------------|
| EL0000452 | Alb / White |
| EL0000465 | Nuc închis / Dark walnut |

ÎNTRERUPĂTOR CRUCE CROSS SWITCH



| Cod / Code | Culoare / Colors |
|------------|------------------|
| EL0000454 | Alb / White |

ÎNTRERUPĂTOR DUBLU DOUBLE SWITCH



| Cod / Code | Culoare / Colors |
|------------|--------------------------|
| EL0000448 | Alb / White |
| EL0000520 | Cireș / Cherry |
| EL0000461 | Nuc închis / Dark walnut |

ÎNTRERUPĂTOR DUBLU CU LED DOUBLE SWITCH WITH LED



| Cod / Code | Culoare / Colors |
|------------|------------------|
| EL001116 | Alb / White |

ÎNTRERUPĂTOR DUBLU CAP-SCARĂ TWO WAY DOUBLE SWITCH



| Cod / Code | Culoare / Colors |
|------------|------------------|
| EL0000453 | Alb / White |

ÎNTRERUPĂTOR SONERIE DOOR BELL SWITCH



| Cod / Code | Culoare / Colors |
|------------|------------------|
| EL0000451 | Alb / White |

16A 230V IP20 PT

PRIZĂ SIMPLĂ FĂRĂ ÎMPĂMÂNTARE
SINGLE SOCKET NON-EARTHED



Cod / Code Culoare / Colors
EL0000455 Alb / White

PRIZĂ DUBLĂ FĂRĂ ÎMPĂMÂNTARE
DOUBLE SOCKET NON-EARTHED



Cod / Code Culoare / Colors
EL0000458 Alb / White

PRIZĂ SCHUKO
SCHUKO SOCKET



Cod / Code Culoare / Colors
EL0000456 Alb / White
EL0000493 Cireș / Cherry
EL0000469 Nuc închis / Dark walnut

PRIZĂ SCHUKO DUBLĂ
SCHUKO DOUBLE SOCKET



Cod / Code Culoare / Colors
EL0000459 Alb / White
EL0000496 Cireș / Cherry
EL0000472 Nuc închis / Dark walnut

PRIZĂ SCHUKO CU CAPAC
SCHUKO SOCKET WITH COVER



Cod / Code Culoare / Colors
EL0013615 Alb / White

PRIZĂ TV CONECTOR F
TV SOCKET „F” TYPE



Cod / Code Culoare / Colors
EL001118 Alb / White

PRIZĂ UTP CAT 6E
CAT 6E UTP SOCKET



Cod / Code Culoare / Colors
EL0024147 Alb / White





GAMA DE APARATAJ EVA

EVA PRODUCT RANGE

RO

Gama de aparataj EVA este proiectată pentru a îndeplini cerințele aplicațiilor electrice atât în medii rezidențiale, cât și comerciale. Aceasta include întrerupătoare cu o tensiune nominală de 250V și un curent nominal de 10A, cu un grad de protecție IP54, fiind adecvate pentru utilizare în medii expuse la praf și umiditate. Instalarea se realizează prin conexiune cu șurub, fiind destinată montării pe suprafață. Gama EVA include, de asemenea, prize cu tensiunea nominală de 250V și curentul nominal de 16A, echipate cu doi poli și împământare, asigurând o conexiune sigură și fiabilă pentru alimentarea diverselor echipamente electrice.

REPERE

- **Instalare ușoară** - se montează rapid pe orice suprafață, fără intervenții complicate;
- **Design modern** - formă compactă și estetică, adaptabilă oricărui tip de spațiu;
- **Fiabilitate** - materiale durabile și sigure, ideale pentru utilizare îndelungată.

EN

The EVA range of electrical devices is designed to meet the requirements of electrical applications in both residential and commercial environments. It includes switches with a rated voltage of 250V and a rated current of 10A, featuring an IP54 protection rating, making them suitable for use in environments exposed to dust and moisture. Installation is achieved through screw connection, intended for surface mounting. The EVA range also includes sockets with a rated voltage of 250V and a rated current of 16A, equipped with two poles and grounding, ensuring a safe and reliable connection for powering various electrical devices.

FEATURES

- **Easy installation** - quickly mounts on any surface without complex interventions.
- **Modern design** - compact and stylish, suitable for any type of space.
- **Reliability** - durable and safe materials, ideal for long-term use.



ÎNTRERUPĂTOR SIMPLU SINGLE SWITCH



| Cod / Code | Culoare / Colors |
|------------|------------------|
| EL0012793 | Gri / Gray |

ÎNTRERUPĂTOR DUBLU DOUBLE SWITCH



| Cod / Code | Culoare / Colors |
|------------|------------------|
| EL0012795 | Gri / Gray |

ÎNTRERUPĂTOR CRUCE CROSS SWITCH



| Cod / Code | Culoare / Colors |
|------------|------------------|
| EL0012800 | Gri / Gray |

ÎNTRERUPĂTOR CAP-SCARĂ TWO WAY SWITCH



| Cod / Code | Culoare / Colors |
|------------|------------------|
| EL0012798 | Gri / Gray |

ÎNTRERUPĂTOR DUBLU CAP-SCARĂ DOUBLE TWO WAY SWITCH



| Cod / Code | Culoare / Colors |
|------------|------------------|
| EL0012825 | Gri / Gray |

ÎNTRERUPĂTOR SONERIE DOOR BELL SWITCH



| Cod / Code | Culoare / Colors |
|------------|------------------|
| EL0012797 | Gri / Gray |

16A 230V IP54 PT

PRIZĂ SCHUKO CU CAPAC
SCHUKO SOCKET WITH COVER



Cod / Code Culoare / Colors
EL0012801 Gri / Gray

PRIZĂ DUBLĂ SCHUKO CU CAPAC
SCHUKO DOUBLE SOCKET WITH COVER



Cod / Code Culoare / Colors
EL0012808 Gri / Gray

10A 230V IP54 PT

MODUL ÎNTRERUPĂTOR CAP-SCARĂ + PRIZĂ SCHUKO CU CAPAC
MODULE TWO WAY SWITCH + SCHUKO SOCKET WITH COVER



Cod / Code Culoare / Colors
EL0012807 Gri / Gray

MODUL ÎNTRERUPĂTOR SIMPLU + PRIZĂ SCHUKO CU CAPAC CAP-SCARĂ
MODULE SINGLE SWITCH + SCHUKO SOCKET WITH COVER

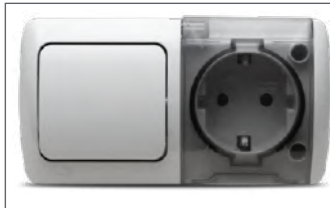

Cod / Code Culoare / Colors
EL0012802 Gri / Gray

MODUL ÎNTRERUPĂTOR DUBLU + PRIZĂ SCHUKO CU CAPAC
MODULE DOUBLE SWITCH + SCHUKO SOCKET WITH COVER

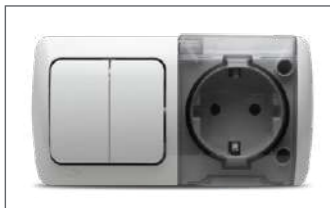

Cod / Code Culoare / Colors
EL0012804 Gri / Gray





GAMA DE APARATAJ TOTAL GREEN TOTAL GREEN PRODUCT RANGE

RO

Gama de aparataj Total Green este proiectată pentru montaj aplicat, oferind o soluție durabilă și fiabilă pentru diverse aplicații electrice. Cu un grad de protecție IP55, aceste dispozitive sunt rezistente la praf și la jeturi de apă, fiind adecvate pentru utilizare în medii unde protecția împotriva factorilor externi este esențială. Tensiunea nominală de 220-240V asigură o funcționare stabilă și sigură, potrivită pentru nevoile electrice atât în mediul rezidențial, cât și în cel comercial. Gama Total Green îmbină performanța cu fiabilitatea, oferind o soluție practică și eficientă pentru instalații electrice care necesită protecție și durabilitate în utilizare.

REPERE

- **Protecție IP55** - rezistență la praf și jeturi de apă, ideală pentru medii solicitante;
- **Tensiune nominală 220-240V** - funcționare stabilă și sigură pentru aplicații rezidențiale și comerciale;
- **Montaj aplicat** - soluție durabilă și eficientă pentru instalații electrice diverse.

EN

The Total Green range of electrical device is designed for surface mounting, offering a durable and reliable solution for various electrical applications. With an IP55 protection rating, these devices are resistant to dust and water jets, making them suitable for environments where protection against external factors is essential. The rated voltage of 220-240V ensures stable and safe operation, meeting the electrical needs of both residential and commercial applications. The Total Green range combines performance with reliability, providing a practical and efficient solution for electrical installations requiring protection and durability.

FEATURES

- **IP54 protection** - resistant to dust and water splashes, ideal for demanding environments;
- **Nominal voltage: 220-240V** - stable and safe operation for residential and commercial applications;
- **Surface mounting** - a durable and efficient solution for various electrical installation.

16A 230V IP55 PT

ÎNTRERUPĂTOR SIMPLU SINGLE SWITCH



Cod / Code Culoare / Colors
EL0014150 Alb / White

ÎNTRERUPĂTOR DUBLU DOUBLE SWITCH



Cod / Code Culoare / Colors
EL0014151 Alb / White

PRIZĂ SCHUKO SCHUKO SOCKET



Cod / Code Culoare / Colors
EL0014153 Alb / White

PRIZĂ DUBLĂ SCHUKO SCHUKO DOUBLE SOCKET

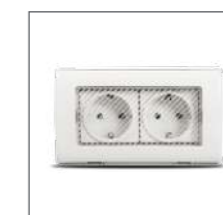

Cod / Code Culoare / Colors
EL0014154 Alb / White

MODUL PRIZĂ SCHUKO + ÎNTRERUPĂTOR SIMPLU MODULE SCHUKO SOCKET + SINGLE SWITCH

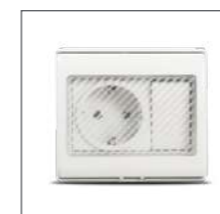

Cod / Code Culoare / Colors
EL0014155 Alb / White



GAMA DE APARATAJ NOVELITE NOVELITE PRODUCT RANGE

RO

Gama de aparataj Novelite este proiectată pentru montaj aplicat, oferind o soluție durabilă și fiabilă pentru o varietate de medii. Echipamentele din această gamă au un grad de protecție IP54, ceea ce le face rezistente la praf și la stropiri cu apă, fiind adecvate pentru utilizare în condiții mai exigente. Cu un curent nominal de 16A, Novelite asigură o funcționare eficientă și sigură, potrivită pentru nevoile electrice obișnuite. Această gamă combină durabilitatea și performanța, oferind o soluție versatilă și de încredere pentru diverse instalații electrice, atât în medii rezidențiale, cât și comerciale.

REPERE

- **Protecție IP54** - Rezistență la praf și stropiri cu apă, ideală pentru medii exigente;
- **Curent nominal 16A** - Asigură o funcționare eficientă și sigură pentru nevoile electrice obișnuite;
- **Montaj aplicat** - Soluție durabilă și fiabilă pentru instalații rezidențiale și comerciale.

EN

The Novelite range of electrical devices is designed for surface mounting, offering a durable and reliable solution for various environments. The equipment in this range features an IP54 protection rating, making it resistant to dust and water splashes, suitable for use in more demanding conditions. With a rated current of 16A, Novelite ensures efficient and safe operation, meeting standard electrical needs. This range combines durability and performance, providing a versatile and dependable solution for various electrical installations, both in residential and commercial environments.

FEATURES

- **IP54 Protection** - Resistant to dust and water splashes, ideal for demanding environments;
- **Rated Current 16A** - Ensures efficient and safe operation for standard electrical needs;
- **Surface Mounting** - Durable and reliable solution for residential and commercial installations.



ÎNTRERUPĂTOR SIMPLU SINGLE SWITCH



| Cod / Code | Culoare / Colors |
|------------|------------------|
| EL0024871 | Alb / White |

ÎNTRERUPĂTOR DUBLU DOUBLE SWITCH



| Cod / Code | Culoare / Colors |
|------------|------------------|
| EL0024872 | Alb / White |

PRIZĂ SCHUKO CU CAPAC IP54 SCHUKO SOCKET WITH COVER



| Cod / Code | Culoare / Colors |
|------------|------------------|
| EL0024873 | Alb / White |

PRIZĂ DUBLĂ SCHUKO CU CAPAC SCHUKO DOUBLE SOCKET WITH COVER

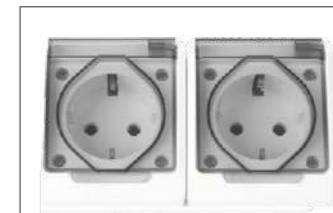

| Cod / Code | Culoare / Colors |
|------------|------------------|
| EL0024874 | Alb / White |



CONECTICĂ

CONNECTORS

| | |
|--|-----|
| Prelungitoare - <i>Extension cord</i> | 256 |
| Grupuri priză - <i>Power strips without cord</i> | 260 |
| Ștechere-cuple - <i>Plugs and couplings</i> | 262 |
| Întrerupătoare pe fir - <i>On-wire switches</i> | 264 |
| Adaptoare - <i>Adapters</i> | 266 |
| Prize programabile - <i>Programmable sockets</i> | 268 |
| Sonerie fără fir - <i>Wireless doorbells</i> | 270 |
| Accesorii TV - <i>TV accessories</i> | 272 |
| Ventilatoare - <i>Fans</i> | 274 |



PRELUNGITOARE EXTENSION CORD

RO

Prelungitoarele sunt soluția ideală pentru extinderea accesului la sursele de curent electric. Concepute pentru a răspunde nevoilor diverse, acestea sunt disponibile în variante multiple, de la modele simple, pentru uz casnic, până la opțiuni avansate, echipate cu protecție împotriva supratensiunilor.

REPERE

- **Flexibilitate optimă** – cabluri disponibile în diverse lungimi, pentru instalare ușoară;
- **Durabilitate** – materiale rezistente la uzură;
- **Siguranță** – protecție pentru copii integrată, pentru utilizare fără griji.

EN

Extension cords are the perfect solution for expanding access to electrical power sources. Designed to meet various needs, they range from simple models for home use to advanced options with surge protection features.

FEATURES

- **Optimal flexibility** – cables available in various lengths for easy installation;
- **Durability** – wear-resistant materials;
- **Safety** – integrated child protection for worry-free use.



| RO | Cod | Nr. prize | Lungime cablu | Întreprupător | Putere maximă | Cordon alimentare | Culoare | Curent | Material | Temp. mediului de utilizare |
|----|------|-------------|---------------|---------------|---------------|-------------------|---------|---------|----------|-----------------------------|
| EN | Code | No. sockets | Cable length | Switch | Maximum power | Power cord | Color | Current | Material | Ambient temp. |

HOMELIGHT

| | | | | | | | | | |
|-----------|---|------|----------|-------|-----------------------------|----------------|-----|----|---------------|
| EL0080843 | 3 | 1.5m | Nu / No | 2500W | CCA 3x1.5mm ² | Alb / White | 10A | PP | -10°C + +60°C |
| EL0080845 | | 1.5m | Da / Yes | | | | | | |
| EL0080846 | | 3m | Nu / No | | | | | | |
| EL0080847 | | 5m | Nu / No | | | | | | |

INLET NEW

| | | | | | | | | | |
|-----------|---|------|----------|-------|-------------------------------|----------------|-----|----|---------------|
| EL0074686 | 3 | 1.5m | Nu / No | 2300W | H05VV-F 3x1mm ² | Alb / White | 10A | PP | -10°C + +60°C |
| EL0074687 | | 1.5m | Da / Yes | | | | | | |
| EL0074692 | | 3m | Nu / No | | | | | | |
| EL0074693 | | 3m | Da / Yes | | | | | | |
| EL0074698 | | 5m | Nu / No | | | | | | |
| EL0074699 | | 5m | Da / Yes | | | | | | |
| EL0074688 | 4 | 1.5m | Nu / No | 2300W | H05VV-F 3x1mm ² | Alb / White | 10A | PP | -10°C + +60°C |
| EL0074689 | | 1.5m | Da / Yes | | | | | | |
| EL0074694 | | 3m | Nu / No | | | | | | |
| EL0074695 | | 3m | Da / Yes | | | | | | |
| EL0074700 | | 5m | Nu / No | | | | | | |
| EL0074701 | | 5m | Da / Yes | | | | | | |
| EL0074690 | 6 | 1.5m | Nu / No | 2300W | H05VV-F 3x1mm ² | Alb / White | 10A | PP | -10°C + +60°C |
| EL0074691 | | 1.5m | Da / Yes | | | | | | |
| EL0074696 | | 3m | Nu / No | | | | | | |
| EL0074697 | | 3m | Da / Yes | | | | | | |
| EL0074702 | | 5m | Nu / No | | | | | | |
| EL0074703 | | 5m | Da / Yes | | | | | | |

INLET PLUS

| | | | | | | | | | |
|------------|-----------|----|----------|-------|---------------------------------|----------------|-----|----|---------------|
| EL0037346 | 3 | 5m | Nu / No | 3680W | H05VV-F 3x1.5mm ² | Alb / White | 16A | PC | -40°C + +70°C |
| EL0037347 | | 5m | Da / Yes | | | | | | |
| EL0037345 | 6 | 3m | Nu / No | 3680W | H05VV-F 3x1.5mm ² | Alb / White | 16A | PC | -40°C + +70°C |
| EL0041749 | | 3m | Da / Yes | | | | | | |
| EL0037348 | | 5m | Nu / No | | | | | | |
| EL0037349* | 6 + 2 USB | 3m | Da / Yes | | | | | | |



* EL0037349 are protecție la supratensiune și scurtcircuit.
* EL0037349 has surge and short-circuit protection.

HOMELIGHT



EL0080843 EL0080845 EL0080846 EL0080847

INLET NEW



EL0074686 EL0074687 EL0074692 EL0074693



EL0074698 EL0074699 EL0074688 EL0074689



EL0074694 EL0074695 EL0074700 EL0074701

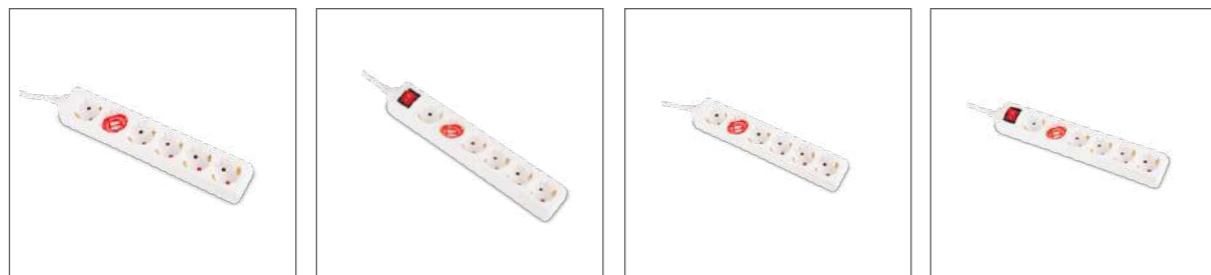

EL0074690 EL0074691 EL0074696 EL0074697

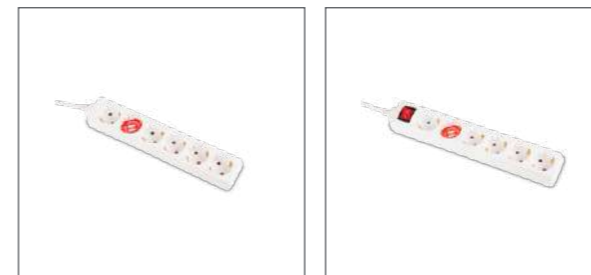

EL0074702 EL0074703

INLET PLUS



EL0037346 EL0037347 EL0037345



EL0041749 EL0037348 EL0037349

CORPURI DE ILLUMINAT DECORATIVE

SURSE

SMART HOME

APARATAJ

CONECTICĂ

PROTECȚII

CORPURI DE ILLUMINAT TEHNICE

TRASEE

CABLURI

DECORATIVE LIGHTING FIXTURES

SOURCES

SMART HOME

SWITCHES AND SOCKETS

CONNECTORS

POWER AUTOMATION

TECHNICAL LIGHTNING FIXTURES

CABLE MANAGEMENT SYSTEMS

CABLES



GRUPURI PRIZĂ

POWER STRIPS WITHOUT CORD

RO

Grupurile de prize oferă soluții versatile și personalizabile pentru gestionarea alimentării electrice. Fără cablu preinstalat, acestea permit configurarea în funcție de nevoile tale, oferindu-ți libertatea de a alege lungimea și tipul de cablu potrivit fiecărei utilizări.

REPERE

- **Personalizare completă** – configurează cablul la lungimea dorită pentru a se potrivi perfect spațiului tău;
- **Practic și versatil** – ideale pentru utilizare în locuințe, birouri sau ateliere;
- **Design robust și fiabil**, cu materiale rezistente și conexiuni sigure.

EN

Power strips provide versatile and customizable solutions for managing electrical power. Without a pre-installed cable, they allow you to configure the setup according to your preferences, giving you the freedom to choose the cable length and type that best suits your requirements.

FEATURES

- **Full customization** – configure the cable to the desired length for a perfect fit in your space;
- **Practical and versatile** – ideal for use in homes, offices, or workshops;
- **Robust and reliable design**, made with durable materials and secure connections.



| RO | Cod | Nr. prize | Întreprupător | Putere maximă | Culoare | Curent | Material | Temp. mediului de utilizare |
|----|------|-------------|---------------|---------------|---------|---------|----------|-----------------------------|
| EN | Code | No. sockets | Switch | Maximum power | Color | Current | Material | Ambient temp. |

INLET PLUS

| | | | | | | | | |
|-----------|---|----------|-------|-------------|-----|----|---------------|--|
| EL0037352 | 3 | | | | | | | |
| EL0037354 | 4 | Da / Yes | 3680W | Alb / White | 16A | PC | -40°C + +70°C | |
| EL0037356 | 6 | | | | | | | |

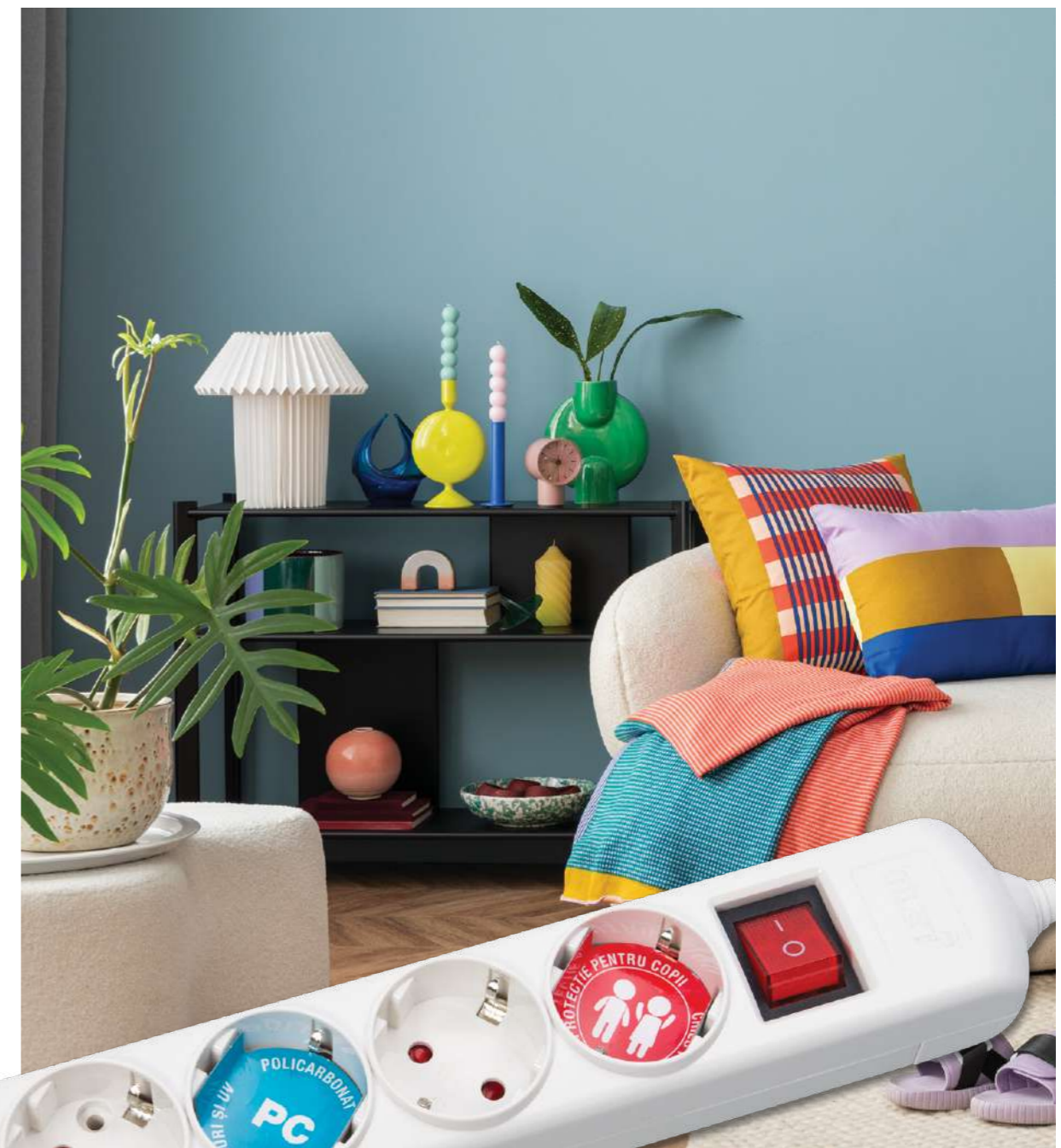



ȘTECHERE-CUPLE PLUGS AND COUPLINGS

RO

Ștecherile și cuplele sunt componente esențiale pentru realizarea unor conexiuni electrice sigure și eficiente. Acestea permit conectarea cablurilor la surse de curent sau la echipamente, asigurând o transmisie de energie stabilă și fiabilă.

REPERE

- **Siguranță sporită** - protejează împotriva scurtcircuitelor și supraîncălzirii;
- **Durabilitate** - realizate din materiale de calitate, rezistente la uzura zilnică;
- **Compatibilitate** - disponibile într-o varietate de tipuri, potrivite pentru diverse echipamente și instalații.

EN

Plugs and couplings are essential components for establishing safe and efficient electrical connections. They allow cables to be connected to power sources or equipment, ensuring stable and reliable energy transmission.

FEATURES

- **Enhanced safety** - protects against short circuits and overheating;
- **Durability** - made from high-quality materials, resistant to daily wear and tear;
- **Compatibility** - available in various types, suitable for different equipment and installations.



| RO | Cod | Denumire | Grad protecție | Curent | Tip priză | Tip ștecher | Protecție copii | Putere maximă | Material | Culoare | Temp. mediei de utilizare |
|----|------|----------|---------------------------|---------|-------------|-------------|-------------------------|---------------|----------|---------|---------------------------|
| EN | Code | Name | Ingress protection rating | Current | Socket type | Plug type | Child safety protection | Maximum power | Material | Color | Ambient temp. |

INLET

| | | | | | | | | | | | |
|-----------|--|------|-----|-----------------------|-----------------------|----|-------|------------------------------|------------------------------|-------------|---------------|
| EL0037335 | Ștecher plat fără CP cu inel / Ring flat plug without ground | IP20 | 10A | - | Fără CP / non-earthed | - | - | 2500W | Plastic | Alb / White | -15°C + +70°C |
| EL0040270 | Ștecher plat fără CP / Flat plug without ground | | | - | - | - | - | - | Policarbonat / Polycarbonate | | |
| EL0040271 | Cuplă plată fără CP / Coupling without ground | | | Fără CP / non-earthed | - | Da | 2300W | Policarbonat / Polycarbonate | | | |
| EL0037342 | Adaptor călătorie / Travel adapter | IP44 | 16A | SCHUKO | SCHUKO | Da | 2500W | Cauciuc / Rubber | Negru / Black | | |
| EL0037333 | Ștecher cauciucat / Rubber plug | | | - | - | - | - | - | - | | |
| EL0037332 | Cuplă cauciucată / Rubber coupling | | | SCHUKO | - | Da | 3500W | Cauciuc / Rubber | Negru / Black | | |

NOVELITE

| | | | | | | | | | | | |
|-----------|--|------|--------|--------|-----------------------|---|---|---|---------------|-------------|---------------|
| EL0021183 | Ștecher plat fără CP / Flat plug without ground | IP20 | 10A | - | Fără CP / non-earthed | - | - | - | ABS | Alb / White | -10°C + +80°C |
| EL0021189 | Ștecher ceramică cu CP și inel / Ceramic ring plug | | | - | - | - | - | - | Negru / Black | | |
| EL0020887 | Ștecher ceramică cu CP și inel / Ceramic ring plug | 16A | SCHUKO | - | SCHUKO | - | - | - | ABS | Alb / White | |
| EL0020886 | Cuplă ceramică cu CP / Ceramic coupling | | | SCHUKO | - | - | - | - | Alb / White | | |



EL0037335

EL0040270

EL0040271

EL0037342

EL0037333



EL0037332

EL0021183

EL0021189

EL0020887

EL0020886



ÎNTRERUPĂTOARE PE FIR ON-WIRE SWITCHES

RO

Întrerupătoarele pe fir sunt soluții convenabile pentru controlul alimentării electrice în circuite. Acestea permit oprirea sau pornirea rapidă a energiei electrice într-un anumit punct al instalației, oferind un mod practic de a gestiona echipamentele conectate.

REPERE

- **Control ușor** – acționare simplă pentru întreruperea sau restabilirea curentului electric;
- **Compatibilitate largă** – potrivite pentru o gamă variată de aplicații și echipamente;
- **Instalare rapidă și simplă** – fără necesitatea unor modificări complexe ale instalației.

EN

Wired switches are convenient solutions for controlling electrical power in circuits. They allow for quick on/off operation of the power at a specific point in the installation, offering a practical way to manage connected devices.

FEATURES

- **Easy control** – simple operation to interrupt or restore electrical current;
- **Wide compatibility** – suitable for a variety of applications and equipment;
- **Quick and easy installation** – with no need for complex modifications to the setup.

IP20 230V

| RO | Cod | Curent | Putere maximă | Material | Culoare | Temp. mediului de utilizare |
|----|------|---------|---------------|----------|---------|-----------------------------|
| EN | Code | Current | Maximum power | Material | Color | Ambient temperature |

INLET

| | | | | | |
|-----------|----|-------|------------------------------|--------------------------|---------------|
| EL0040662 | 6A | 1800W | Policarbonat / Polycarbonate | Alb + Roșu / White + Red | -10°C + +60°C |
|-----------|----|-------|------------------------------|--------------------------|---------------|

NOVELITE

| | | | | | |
|-----------|----|------|-----|-------------|---------------|
| EL0021187 | 2A | 600W | ABS | Alb / White | -10°C + +80°C |
|-----------|----|------|-----|-------------|---------------|



EL0040662



EL0021187





ADAPTOARE ADAPTERS

RO

Adaptoarele de priză oferă o soluție simplă pentru a conecta mai multe dispozitive la o singură priză. Acestea sunt ideale pentru utilizarea în spații unde sunt necesare multiple conexiuni electrice, economisind astfel loc și facilitând gestionarea echipamentelor.

REPERE

- **Conectivitate extinsă** – permite conectarea mai multor dispozitive simultan;
- **Practicitate** – soluție compactă și ușor de utilizat;
- **Compatibilitate** – se pot utiliza cu majoritatea tipurilor de prize și echipamente.

EN

Power socket adapters offer a simple solution for connecting multiple devices to a single socket. They are ideal for use in spaces where multiple electrical connections are needed, saving space and making it easier to manage equipment.

FEATURES

- **Extended connectivity** – allows you to connect multiple devices simultaneously;
- **Convenience** – compact and easy-to-use solution;
- **Compatibility** – works with most types of sockets and equipment.

IP20 230V

| RO | Cod | Denumire | Curent | Putere maximă | Număr prize | Tip priză | Tip ștecher | Material | Culoare | Temp. mediului de utilizare |
|----|------|----------|---------|---------------|-------------|-------------|-------------|----------|---------|-----------------------------|
| EN | Code | Name | Current | Maximum power | No. sockets | Socket type | Plug type | Material | Color | Ambient temp. |

INLET

| | | | | | | | | | | |
|-----------|---|--|-----|-------|---|-----------------------|-----------------------|------------------------------|-------------|---------------|
| EL0040660 | Priză triplă / Triple socket | | 16A | 3500W | | | | | | |
| EL0040664 | Triplu ștecher liniar / Triple linear plug | | 16A | 3680W | 3 | SCHUKO | SCHUKO | ABS | Alb / White | -25°C + +70°C |
| EL0077929 | Triplu ștecher plat fără cp / Triple flat plug without ground | | 10A | 2200W | | Fără CP / non-earthed | Fără CP / non-earthed | Polycarbonat / Polycarbonate | | -15°C + +70°C |

NOVELITE

| | | | | | | | | | | |
|-----------|--|--|-----|-------|---|--------|--------|------------------------------|-------------|---------------|
| EL0018999 | Adaptor 3 prize rotund / 3 sockets adapter | | 16A | 3680W | 3 | SCHUKO | SCHUKO | Polycarbonat / Polycarbonate | Alb / White | -15°C + +70°C |
|-----------|--|--|-----|-------|---|--------|--------|------------------------------|-------------|---------------|



EL0040660



EL0040664



EL0077929



EL0018999



PRIZE PROGRAMABILE PROGRAMMABLE SOCKETS

RO

Priza programabilă mecanică oferă un control complet asupra alimentării electrice a dispozitivelor conectate, permițându-ți să stabilești ora exactă la care să pornească sau să se oprească curentul. Ideală pentru economisirea energiei și pentru automatizarea funcționării echipamentelor, această priză este potrivită pentru aplicații casnice și comerciale.

REPERE

- **Control precis** – programează pornirea sau oprirea curentului electric la intervale prestabilite;
- **Economisire de energie** – controlează când echipamentele sunt alimentate, reducând consumul inutil;
- **Simplitate și fiabilitate** – fără configurări complicate, ușor de utilizat.

EN

A mechanical programmable socket provides complete control over the power supply to connected devices, allowing you to set specific times for turning the power on or off. Ideal for energy savings and automating device operation, this socket is suitable for both home and commercial applications.

FEATURES

- **Precise control** – schedule the power on/off times at set intervals;
- **Energy savings** – control when devices are powered to reduce unnecessary consumption;
- **Simplicity and reliability** – easy to use with no complicated setup.



| RO | Cod | Denumire | Putere maximă | Număr prize | Interval de reglare | Programare | Culoare | Temp. mediului de utilizare |
|----|------|----------|---------------|-------------|---------------------|-------------|---------|-----------------------------|
| EN | Code | Name | Maximum power | No. sockets | Adjustment interval | Programming | Color | Ambient temp. |

INLET

| | | | | | | | |
|-----------|---|-------|---|-----|----------------------|------------|-------------|
| EL0041724 | Priză programabilă mecanică / Mechanical programmable socket | 3680W | 1 | 30' | 24 ore / 24 hours | Alb /White | 0°C + +55°C |
|-----------|---|-------|---|-----|----------------------|------------|-------------|



EL0041724





SONERII FĂRĂ FIR WIRELESS DOORBELLS

RO

Soneriile fără fir sunt o soluție modernă, ușor de instalat, fără a necesita cabluri sau instalări complicate. Acestea transmit semnalul între butonul soneriei și receptorul sonor prin unde radio, oferindu-ți libertatea de a le instala oriunde în casa ta, fără a fi nevoie de lucrări de cablare.

REPERE

- **Instalare rapidă și simplă** – nu necesită cabluri, fiind gata de utilizare imediat;
- **Mobilitate și flexibilitate** – receptorul poate fi plasat oriunde în locuință, iar butonul soneriei poate fi montat pe orice ușă sau perete;
- **Varietate de melodii** – personalizare completă pentru o experiență plăcută.

EN

Wireless doorbells are a modern, easy-to-install solution that require no wiring or complicated setup. They transmit the signal between the doorbell button and the chime receiver via radio waves, giving you the freedom to install them anywhere in your home—without the need for electrical work.

FEATURES

- **Quick and easy installation** – no cables required, ready for use immediately;
- **Mobility and flexibility** – the receiver can be placed anywhere in the home, and the doorbell button can be mounted on any door or wall;
- **Variety of melodies** – complete customization for a pleasant experience.



| RO | Cod | Denumire | Tensiune receptor | Nivel sonor | Distanța de utilizare | Număr melodii | Material | Culoare | Temp. mediului de utilizare |
|----|------|----------|-------------------|-------------|-----------------------|---------------------|----------|---------|-----------------------------|
| EN | Code | Name | Receiver voltage | Sound level | Range | Number of ringtones | Material | Color | Ambient temp. |

NOVELITE

| | | | | | | | | |
|-----------|---|--|---------|-----------|----|-----|----------------|---------------|
| EL0052530 | Sonerie fără fir 230V / Wireless doorbell 230V | 230V | 80-90dB | max.100 m | 32 | ABS | Alb / White | -15°C + +70°C |
| EL0052529 | Sonerie fără fir 2x1.5V / Wireless doorbell 2x1.5V | 2x1.5V (baterie AAA) / (AAA battery) | | | | | | |



EL0052530



EL0052529



Tensiunea transmițătorului de 12V este dată de o baterie A23. / 12V transformer voltage, given by an A23 battery.

Frecvența de transmisie radio este 433MHz. / Radio transmission frequency is 433MHz.

Au protecție împotriva interferențelor. / Have protection against interference.



ACCESORII TV TV ACCESSORIES

RO

Accesoriile TV, cum ar fi mufele, sunt esențiale pentru asigurarea conexiunilor de înaltă calitate între televizor și alte dispozitive, precum antene, receptoare TV sau sisteme audio. Acestea oferă soluții fiabile pentru orice configurație de divertisment.

REPERE

- Conexiuni sigure și stabile – pentru o performanță optimă a semnalului;
- Compatibilitate largă – se potrivesc cu majoritatea echipamentelor audio-video;
- Instalare ușoară – mufele sunt simple de conectat, fără unelte speciale.

EN

TV accessories, such as connectors, are essential for ensuring high-quality connections between your TV and other devices like antennas, TV receivers, or audio systems. They provide reliable solutions for any entertainment setup.

FEATURES

- Secure and stable connections – for optimal signal performance;
- Wide compatibility – compatible with most audio-video equipment;
- Easy installation – connectors are simple to attach without the need for special tools.

| RO | Cod | Denumire |
|----|------|----------|
| EN | Code | Name |

NOVELITE

| | |
|-----------|--|
| EL0039729 | Mufă F RG6 / F connector RG6 |
| EL0039733 | Mufă TV mamă F OC / TV female F connector OC |
| EL0039725 | Mufă TV mamă 9.5mm cot 90° / TV female connector 9.5mm elbow 90° |
| EL0039732 | Mufă TV tată F OC / TV male F connector OC |
| EL0039724 | Mufă TV tată 9.5mm cot 90° / TV male connector 9.5mm elbow 90° |
| EL0039731 | Prelungitor mufă F / Extension coupler |
| EL0039726 | Splitter CATV 2m 5-1000mhz / CATV Splitter 2m 5-1000mhz |
| EL0039727 | Splitter CATV 3m 5-1000mhz / CATV Splitter 3m 5-1000mhz |
| EL0039728 | Splitter CATV 4m 5-1000mhz / CATV Splitter 4m 5-1000mhz |



EL0039729



EL0039733



EL0039725



EL0039732



EL0039724



EL0039731



EL0039726



EL0039727



EL0039728



VENTILATOARE FANS

RO

Ventilatoarele sunt esențiale pentru menținerea unui aer curat și proaspăt în spațiile cu umiditate ridicată sau unde circulația aerului este limitată. Acestea ajută la eliminarea aburului, mirosurilor neplăcute și a umezelii, contribuind la prevenirea formării mușgaiului și asigurând un mediu sănătos și confortabil.

REPERE

- **Îmbunătățirea calității aerului** – elimină rapid umiditatea și mirosurile neplăcute;
- **Ușor de instalat** – design compact ce permite montarea rapidă în diverse tipuri de încăperi;
- **Eficiență energetică** – consum redus de energie pentru o performanță optimă.

EN

Fans are essential for maintaining clean and fresh air in spaces with high humidity or areas where air circulation is limited. They help eliminate moisture, unpleasant odors, and steam, preventing mold formation and ensuring a healthy and comfortable environment.

FEATURES

- **Improved air quality** – quickly removes moisture and unpleasant odors;
- **Easy installation** – compact design allows for quick mounting in various types of rooms;
- **Energy efficiency** – low energy consumption for optimal performance.

230V

| RO | Cod | Grad protecție | Putere | Nivel zgomot | rotații pe minut | Putere extracție aer | Clapetă antiretur | Senzor umiditate | Dimensiune | Prezență timer | Material | Culoare | Temp. mediului de utilizare |
|----|------|---------------------------|--------|--------------|----------------------|----------------------|----------------------|------------------|------------|----------------|----------|---------|-----------------------------|
| EN | Code | Ingress protection rating | Power | Noise level | Rotations per minute | Air circulation | Backdraught shutters | Humidity sensor | Size | Timer | Material | Color | Ambient temp. |

NOVELITE

| EL0052324 | ADAPTOR 120MM | | | | | | | | | | | | |
|-----------|---------------|-----|------|---------|-----------------------|----------|----------|----------|--------------------------|---------|-----|-------------|--------------|
| EL0052321 | | | | | | | | Nu / No | 140x140x80x100/120x16 mm | Nu / No | ABS | Alb / White | +5°C + +40°C |
| EL0052322 | IPX4 | 15W | 32db | 2550rpm | 100 m ³ /h | Da / Yes | | Da / Yes | | | | | |
| EL0052323 | | | | | | | Da / Yes | | | | | | |

TOTAL GREEN

| | | | | | | | | | | | | |
|-----------|------|----|---|------|-----|----------|---------|----------------------|----------------------|----|-------------|-------------|
| EL0017168 | IP20 | 14 | - | 2300 | 110 | Da / Yes | Nu / No | 155x155x78x100x21 mm | Nu / No | PS | Alb / White | 0°C + +45°C |
| EL0017169 | IP20 | 17 | - | 2400 | 205 | Nu / No | Nu / No | | 175x175x78x125x21 mm | | | |



EL0052321



EL0052322



EL0052323



EL0052324

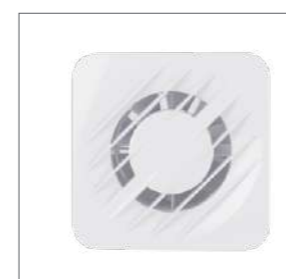

EL0017168



EL0017169

PROTECȚII

POWER AUTOMATION

| | |
|--|-----|
| Înterupătoare automate - Modular circuit breakers | 278 |
| Înterupătoare cu protecție diferențială - Residual current circuit breakers | 280 |
| Siguranțe fuzibilă - Fuses | 282 |
| Contactoare - Contactors | 284 |
| Comutatoare cu came - Cam switches | 286 |
| Tablouri / cofrete metalice - Metallic electrical boxes | 288 |
| Programator tensiune - Voltage output digital switch | 290 |
| Priză șină DIN - DIN rail socket | 291 |



ÎNTRERUPĂTOARE AUTOMATE

MODULAR CIRCUIT BREAKERS

RO

Total Green îți oferă întrerupătoare automate pentru protecția eficientă a instalațiilor electrice. Simplu de instalat și fiabile, acestea asigură protecția împotriva suprasarcinilor și scurtcircuitelor, fiind o soluție practică pentru orice tip de clădire.

REPERE

- **Gamă completă** – disponibile de la 6 la 63A, cu declanșare rapidă la defecte;
- **Protecție eficientă** – protecție împotriva suprasarcinilor și scurtcircuitelor;
- **Compatibilitate** – design modular, adaptat pentru montaj pe șină DIN.

EN

Total Green offers reliable circuit breakers designed to protect electrical installations. They are easy to install and provide effective protection against overloads and short circuits, making them a practical choice for any building.

FEATURES

- **Complete range** – available from 6 to 63A, with rapid fault tripping;
- **Efficient protection** – safeguards against overloads and short circuits;
- **Compatibility** – modular design, suitable for DIN rail mounting.

Curba
C

CARACTERISTICI TEHNICE / TECHNICAL SPECIFICATIONS

| RO | Cod | Denumire | Curent nominal | Nr. poli | Tensiune nominală | Dimensiuni (hxlxL) | Capacitate nominală de rupere la scurtcircuit |
|----|------|----------|----------------|--------------|-------------------|--------------------|---|
| EN | Code | Name | Rated current | No. of poles | Rated voltage | Size | Rated short-circuit breaking capacity |



Întrerupător monopolar / Modular Circuit Breaker Single-Pole

TOTAL GREEN

| | | | | | | | | | |
|-----------|--|------|------|------------|------------|------------|-----|------------|-----|
| EL0004091 | Întrerupător automat modular / Modular circuit breaker | 6A | 1 | 230-400V | 83x18x72mm | 6kA | | | |
| EL0004085 | | 10A | | | | | | | |
| EL0004086 | | 16A | | | | | | | |
| EL0004087 | | 20A | | | | | | | |
| EL0004088 | | 25A | | | | | | | |
| EL0004089 | | 32A | | | | | | | |
| EL0004090 | | 40A | | | | | | | |
| EL0004108 | | 50A | | | | | | | |
| EL0029514 | | 63A | | | | | | | |
| EL0004092 | | 10A | | | | | 2 | 83x36x72mm | 6kA |
| EL0004093 | | 16A | | | | | | | |
| EL0004094 | | 20A | | | | | | | |
| EL0004095 | | 25A | | | | | | | |
| EL0004096 | | 32A | | | | | | | |
| EL0004097 | 40A | | | | | | | | |
| EL0004106 | 50A | | | | | | | | |
| EL0029516 | 63A | 3 | 400V | 83x54x72mm | | | | | |
| EL0004098 | 10A | | | | | | | | |
| EL0004099 | 16A | | | | | | | | |
| EL0004100 | 20A | | | | | | | | |
| EL0004101 | 25A | | | | | | | | |
| EL0004102 | 32A | | | | | | | | |
| EL0004103 | 40A | | | | | | | | |
| EL0004104 | 50A | | | | | | | | |
| EL0029518 | 63A | | | | | | | | |
| EL0029519 | 10A | | | | 4 | 83x72x72mm | 6kA | | |
| EL0029520 | 16A | | | | | | | | |
| EL0029521 | 20A | | | | | | | | |
| EL0029522 | 25A | | | | | | | | |
| EL0029523 | 32A | | | | | | | | |
| EL0029524 | 40A | | | | | | | | |
| EL0029525 | 50A | | | | | | | | |
| EL0029526 | 63A | 1P+N | 230V | 83x18x72mm | 4.5kA | | | | |
| EL0027929 | 6A | | | | | | | | |
| EL0004110 | 10A | | | | | | | | |
| EL0004111 | 16A | | | | | | | | |
| EL0004112 | 20A | | | | | | | | |
| EL0004113 | 25A | 1 | 230V | 83x18x72mm | - | | | | |
| EL0004114 | 32A | | | | | | | | |
| EL0004118 | Sonerie modulară / Modular Doorbell | - | 1 | 230V | 83x18x72mm | - | | | |



Întrerupător bipolar / Modular Circuit Breaker Double-Pole



Întrerupător tripolar / Modular Circuit Breaker Triple-Pole



Întrerupător tetrapolar / Modular Circuit Breaker Four-Pole



Întrerupător automat PLN / Modular PLN Circuit Breaker



Sonerie modulară / Modular Doorbell

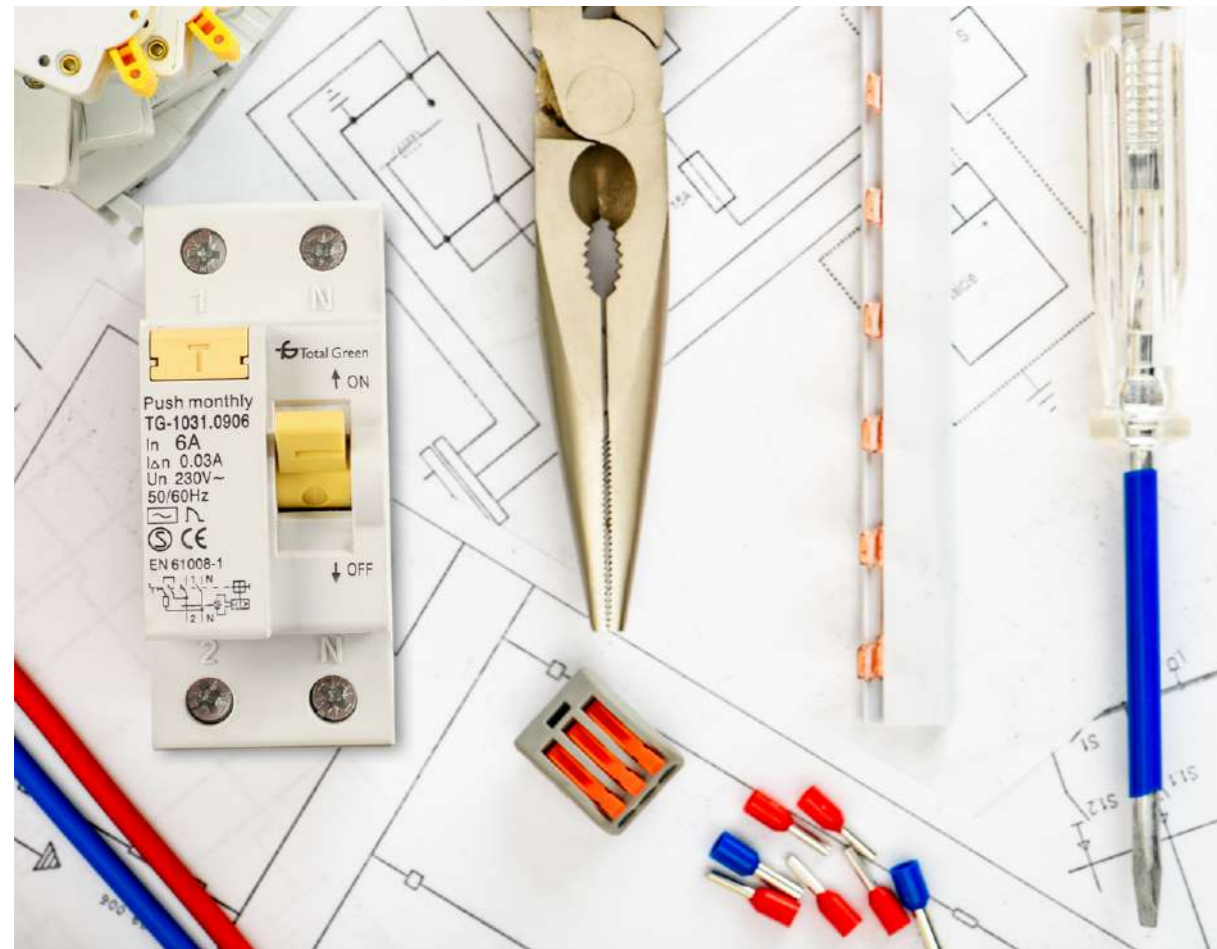

CARACTERISTICI TEHNICE / TECHNICAL SPECIFICATIONS

| RO | Cod | Denumire | Curent nominal | Nr. poli | Tensiune nominală | Curent nominal de defect | Capacitate nominală de rupere la scurtcircuit | Dimensiuni (hxlxL) |
|----|------|----------|----------------|--------------|-------------------|--------------------------|---|--------------------|
| EN | Code | Name | Rated current | No. of poles | Rated voltage | Rated fault current | Rated short-circuit breaking capacity | Size |

TOTAL GREEN

| | | | | | | | | | | | |
|-----------|---|-----|---|------|------|-----|------------|---|------|--|------------|
| EL0029527 | Întreprător automat diferențial / Residual Current Device | 6A | 2 | 230V | 30mA | 6kA | 86x36x72mm | | | | |
| EL0029528 | | 10A | | | | | | | | | |
| EL0009476 | | 16A | | | | | | | | | |
| EL0010730 | | 20A | | | | | | | | | |
| EL0009477 | | 25A | | | | | | | | | |
| EL0027931 | | 32A | | | | | | | | | |
| EL0009478 | | 40A | | | | | | | | | |
| EL0009479 | | 63A | | | | | | | | | |
| EL0029529 | | 25A | | | | | | 4 | 400V | | 83x72x72mm |
| EL0029530 | | 32A | | | | | | | | | |
| EL0029531 | 40A | | | | | | | | | | |
| EL0029532 | 63A | | | | | | | | | | |



Întreprător automat diferențial cu 2 poli / 2-Pole Residual Current Device



Întreprător automat diferențial cu 4 poli / 4-Pole Residual Current Device

ÎNTRERUPĂTOARE CU PROTECȚIE DIFERENȚIALĂ

RESIDUAL CURRENT CIRCUIT BREAKERS

RO

Întreprătoarele diferențiale Total Green oferă protecție sigură împotriva curenților de scurgere și a șocurilor electrice. Acestea detectează rapid pierderile de curent și întrerup alimentarea pentru a preveni riscurile, asigurând o siguranță sporită atât pentru persoane, cât și pentru instalațiile electrice.

REPERE

- **Detecție rapidă** – identifică curenți de scurgere de până la 30mA;
- **Protecție fiabilă** – protecție împotriva șocurilor electrice;
- **Instalare ușoară** – montare directă pe șină DIN.

EN

Total Green's residual current circuit breakers offer reliable protection against ground faults and electric shocks. They quickly detect current leakage and disconnect the circuit to prevent hazards, ensuring enhanced safety for both people and electrical systems.

FEATURES

- **Rapid detection** – identifies leakage currents up to 30mA;
- **Reliable protection** – protection against electric shocks;
- **Easy installation** – DIN rail mounting.

CARACTERISTICI TEHNICE / TECHNICAL SPECIFICATIONS

| RO | Cod | Denumire | Curent nominal | Tensiune nominală | Capacitate nominală de rupere la scurtcircuit | Dimensiuni (LxØ) | Soclu |
|----|------|----------|----------------|-------------------|---|------------------|--------|
| EN | Code | Name | Rated current | Rated voltage | Rated short-circuit breaking capacity | Size | Socket |

TOTAL GREEN

| | | | | | | |
|-----------|---------------------------|-----|------|-------|---------|-----|
| EL0009472 | Siguranță fuzibilă / Fuse | 10A | 230V | 1.5kA | 90x41mm | E27 |
| EL0009473 | | 16A | | | | |
| EL0009474 | | 20A | | | | |
| EL0009475 | | 25A | | | | |
| EL0027930 | | 32A | | | | |



Siguranță fuzibilă / Fuse

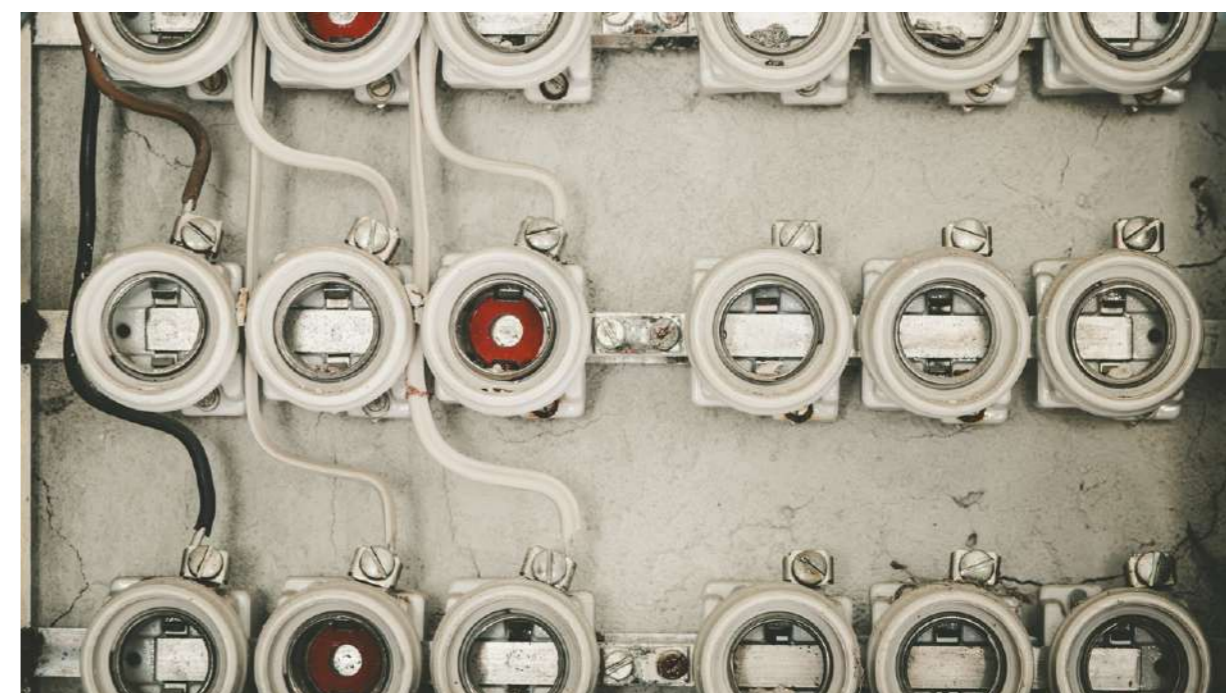

SIGURANȚE FUZIBILĂ

FUSES

RO

Siguranțele fuzibile automate Total Green oferă protecție împotriva suprasarcinilor și scurtcircuitelor. Acestea combină funcționalitatea siguranțelor clasice cu posibilitatea de resetare automată, eliminând necesitatea înlocuirii după declanșare.

REPERE

- **Resetare automată** – revine în funcțiune după declanșare, fără intervenție manuală;
- **Compatibilitate extinsă** – potrivită pentru socluri standard E27;
- **Protecție eficientă** – împotriva suprasarcinilor și scurtcircuitelor.

EN

Total Green automatic fuse switches provide protection against overloads and short circuits. They combine the functionality of traditional fuses with automatic reset capability, eliminating the need for replacement after tripping.

FEATURES

- **Automatic reset** – resumes operation after tripping, no manual intervention required;
- **Extended compatibility** – suitable for standard E27 sockets;
- **Effective protection** – against overloads and short circuits.

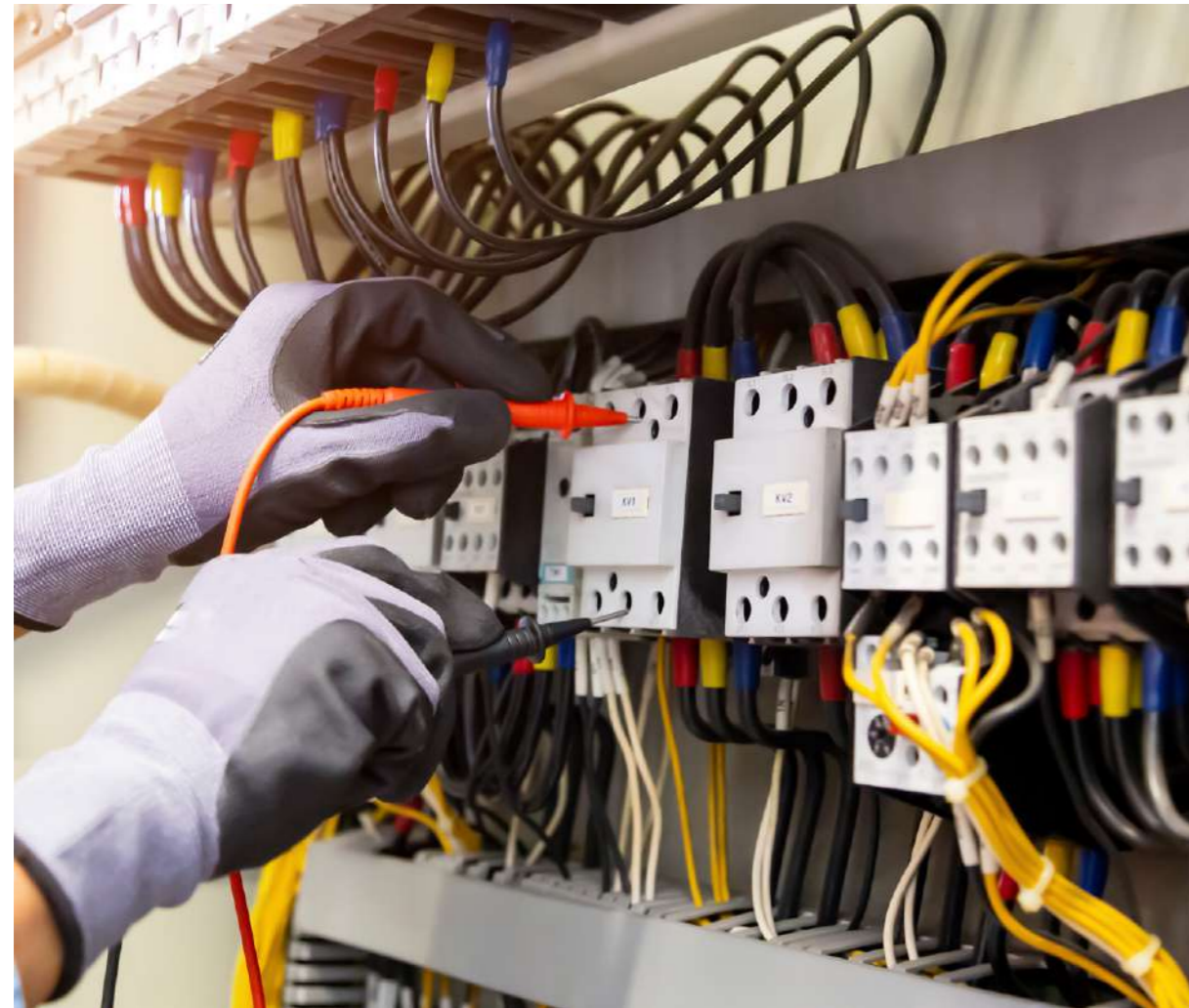

CONTACTOARE

CONTACTORS

RO

Contactoarele Total Green sunt dispozitive electrice esențiale pentru controlul circuitelor de putere. Acestea permit comutarea eficientă a circuitelor electrice de mare capacitate, asigurând funcționarea sigură a instalațiilor industriale și comerciale.

REPERE

- **Capacitate mare** – pentru comutarea sarcinilor electrice intense;
- **Montare facilă** – pe șină DIN, pentru instalare rapidă;
- **Versatilitate** – compatibile cu aplicații industriale și comerciale diverse.

EN

Total Green contactors are essential electrical devices for controlling power circuits. They enable efficient switching of high-capacity electrical equipment, ensuring safe operation in industrial and commercial installations.

FEATURES

- **High capacity** – for switching heavy electrical loads;
- **Easy mounting** – on DIN rail for quick installation;
- **Versatility** – compatible with various industrial and commercial applications.

CARACTERISTICI TEHNICE / TECHNICAL SPECIFICATIONS

| RO | Cod | Denumire | Curent nominal | Tensiune nominală | Tipul de tensiune pentru acționare | Nr. Poli | Numărul de contacte auxiliare cu contact normal deschis | Dimensiuni (hxlxL) |
|----|------|----------|----------------|-------------------|------------------------------------|--------------|---|--------------------|
| EN | Code | Name | Rated current | Rated voltage | Type of voltage for the drive | No. of poles | Number of auxiliary contacts with normally open contact | Size |

TOTAL GREEN

| | | | | | | | | |
|-----------|--------------------------|-----|--------------|------|---|---|--------------|------------|
| EL0029548 | Contactor / Contactor | 16A | 240V | 220V | 1 | 1 | 82x18x66mm | |
| EL0029549 | | 20A | | | | | | |
| EL0029540 | | 9A | 400V | 230V | 3 | | | 73x46x80mm |
| EL0029541 | | 12A | | | | | | |
| EL0029542 | | 18A | | | | | | |
| EL0029543 | | 25A | | | | | | |
| EL0029544 | | 32A | | | | | | |
| EL0029545 | | 40A | | | | | | |
| EL0029546 | | 65A | 126x76x112mm | | | | | |
| EL0029547 | | 95A | | | | | | |
| | | | | | | | 127x86x125mm | |



Contactor cu 1 pol /
1-Pole Contactor



Contactor cu 3 poli /
3-Pole Contactor



CARACTERISTICI TEHNICE / TECHNICAL SPECIFICATIONS



| RO | Cod | Denumire | Curent nominal | Numărul de etaje | Poziții | Potrivit pentru montare frontală | Dimensiuni (LxØ) |
|----|------|----------|----------------|----------------------|-----------|----------------------------------|------------------|
| EN | Code | Name | Rated current | The number of levels | Positions | Frontal fixing | Size |

TOTAL GREEN

| | | | | | | |
|-----------|-----------------------------|-----|---|-------|----------|----------|
| EL0029570 | Comutator came / Cam switch | 20A | 2 | 0-1 | Da / Yes | 74x49mm |
| EL0029571 | | 25A | | | | |
| EL0029574 | | 20A | 3 | 1-0-2 | | 106x65mm |
| EL0029575 | | 25A | | | | |
| EL0029576 | | 32A | | | | |



Comutator cu 2 poli / 2-Pole Cam Switch



Comutator cu 3 poli / 3-Pole Cam Switch

COMUTATOARE CU CAME

CAM SWITCHES

RO

Comutatoarele cu came Total Green oferă un control simplu și eficient al circuitelor electrice. Aceste dispozitive robuste sunt concepute pentru a permite selecția rapidă între diferite poziții, fiind ideale pentru aplicații industriale și comerciale.

REPERE

- **Selecție rapidă** – comutare facilă între poziții multiple;
- **Rezistență mecanică** – construcție solidă pentru utilizare intensivă;
- **Operare facilă** – design ergonomic pentru manevrare comodă.

EN

Total Green cam switches provide simple and efficient control of electrical circuits. These robust devices are designed for quick selection between different positions, making them ideal for industrial and commercial applications.

FEATURES

- **Quick selection** – easy switching between multiple positions;
- **Durability** – robust construction for intensive use;
- **Easy operation** – ergonomic design for comfortable handling





TABLOURI / COFRETE METALICE

METALLIC ELECTRICAL BOXES

RO

Tablourile electrice metalice Total Green oferă o protecție durabilă și sigură pentru instalațiile electrice. Construcția robustă conferă rezistență la condiții dificile, asigurând protecția echipamentelor.

REPERE

- Durabilitate crescută – construcție robustă pentru rezistență la condiții dificile;
- Protecție optimă – asigură siguranța echipamentelor electrice.

EN

Total Green metal electrical boxes provide durable and safe protection for electrical installations. Their robust construction withstands harsh conditions, ensuring equipment protection.

FEATURES

- Enhanced durability – robust construction for resistance to harsh conditions;
- Optimal protection – ensures the safety of electrical equipment.

IP65

CARACTERISTICI TEHNICE / TECHNICAL SPECIFICATIONS

| RO | Cod | Denumire | Material | Culoare | Nr. încuietori | Dimensiuni (hxlxL) |
|----|------|----------|----------|---------|----------------|--------------------|
| EN | Code | Name | Material | Color | No. of locks | Size |

TOTAL GREEN

| | | | | | |
|-----------|--------------------------------|--|--------------------------|----------------|---------------|
| EL0028627 | Dulap metalic / Metal cases | Tablă vopsită electrostatic / Electrostatic coating | Gri / Gray (RAL 7032) | 1 | 250x250x150mm |
| EL0028630 | | | | | 300x250x150mm |
| EL0028628 | | | | | 400x300x150mm |
| EL0028629 | | | | | 500x400x200mm |
| EL0028631 | | | | | 600x400x200mm |
| EL0028636 | | | | | 600x600x250mm |
| EL0031217 | | | | | 700x500x200mm |
| EL0028637 | | | | 800x600x250mm | |
| EL0028632 | | | | 1000x600x250mm | |
| EL0034535 | | | | 1000x800x300mm | |
| EL0028633 | | | | 1200x600x250mm | |
| EL0028634 | | | | 1200x800x350mm | |
| EL0028635 | | | | 1400x600x350mm | |



Dulap metalic /
Metallic box

i Tablourile sunt fabricate cu o singură ușă și au contrapanou pentru montaj echipamente. /
The boxes are manufactured with a single door and have a mounting backplate for equipments.



PROGRAMATOR TENSIUNE VOLTAGE OUTPUT DIGITAL SWITCH

RO

Programatoarele de tensiune Total Green sunt dispozitive inteligente concepute pentru a controla tensiunea din instalațiile electrice. Acestea permit utilizatorilor să programeze intervale de funcționare, asigurând o utilizare eficientă a energiei.

REPERE

- **Control precis** – gestionează funcționarea echipamentelor electrice;
- **Programare flexibilă** – setare ușoară a intervalelor de funcționare;
- **Utilizare intuitivă** – design simplu pentru operare facilă.

EN

Total Green voltage controllers are intelligent devices designed to control and monitor voltage levels in electrical installations. They allow users to program operating intervals, ensuring efficient energy use.

FEATURES

- **Precise control** – manages the operation of electrical equipment;
- **Flexible programming** – easy setting of operating intervals;
- **Intuitive use** – simple design for effortless operation.

CARACTERISTICI TEHNICE / TECHNICAL SPECIFICATIONS

| RO | Cod | Denumire | Nr. Module | Montaj | Numărul de programe | Interval timp programabil | Dimensiuni |
|----|------|----------|------------|----------|---------------------|----------------------------|------------|
| EN | Code | Name | Module No. | Mounting | Number of programs | Programmable time interval | Size |

230V

16A

Tip AC



Programator tensiune / Voltage output digital switch

| TOTAL GREEN | | | | | | | |
|-------------|--|---|---------------------|----|-------------------|----------------|--|
| EL0014681 | Programator tensiune / Voltage output digital switch | 2 | Șină DIN / DIN rail | 16 | 1 - 7 zile / days | 86.5x36x65.5mm | |



PRIZĂ ȘINĂ DIN DIN RAIL SOCKET

RO

Priza pentru șină DIN Total Green este o soluție potrivită pentru conectarea echipamentelor electrice în instalații industriale și comerciale. Proiectată pentru montare pe șină DIN, aceasta oferă un sistem de conectare sigur și ușor accesibil.

REPERE

- **Montare compactă** – ușor de instalat în tablouri electrice, economisind spațiu;
- **Fixare sigură** – stabilă pe șină DIN pentru utilizare fiabilă;
- **Acces facil** – acces rapid la echipamentele conectate.

EN

Total Green DIN socket is a suitable solution for connecting electrical equipment in industrial and commercial installations. Designed for DIN rail mounting, it provides a secure and easily accessible connection system.

FEATURES

- **Compact mounting** – easy installation in electrical panels, saving space;
- **Secure fixing** – stable on DIN rail for reliable use;
- **Easy access** – quick reach to connected equipment.

CARACTERISTICI TEHNICE / TECHNICAL SPECIFICATION

| RO | Cod | Denumire | Curent nominal | Montaj | Tensiune nominală | Nr. module | Dimensiuni |
|----|------|----------|----------------|----------|-------------------|-------------|------------|
| EN | Code | Name | Rated current | Mounting | Rated voltage | No. modules | Size |

IP20



Priză pe șină DIN / DIN rail socket

| TOTAL GREEN | | | | | | | |
|-------------|----------------------------------|-----|---------------------|------|-----|------------|--|
| EL0027422 | Priză șină DIN / DIN rail socket | 16A | Șină DIN / DIN rail | 250V | 2.5 | 85x45x70mm | |

CORPURI DE ILUMINAT TEHNICE

TECHNICAL LIGHTNING FIXTURES

| | |
|--|-----|
| Corpuri liniare interior - Indoor linear light | 294 |
| Panouri LED - LED panels | 302 |
| Downlight - Downlight | 316 |
| Iluminat șină - Track lighting | 320 |
| Corp bat - Bat light | 328 |
| Corpuri etanșe praf și apă - Dust and waterproof lighting fixtures | 332 |
| High bay - High bay | 338 |
| Proiectori LED - LED floodlight | 342 |
| Corpuri stradale și pietonale - Street and pedestrian lights | 348 |
| Stâlpi de iluminat - Lighting poles | 356 |
| Corpuri arhitecturale - Architectural light fixtures | 364 |
| Corpuri solare - Solar fixtures | 366 |
| Iluminat urgență - Emergency lighting | 370 |
| Senzori - Sensors | 378 |
| Accesorii alimentare - Power supply accessories | 382 |

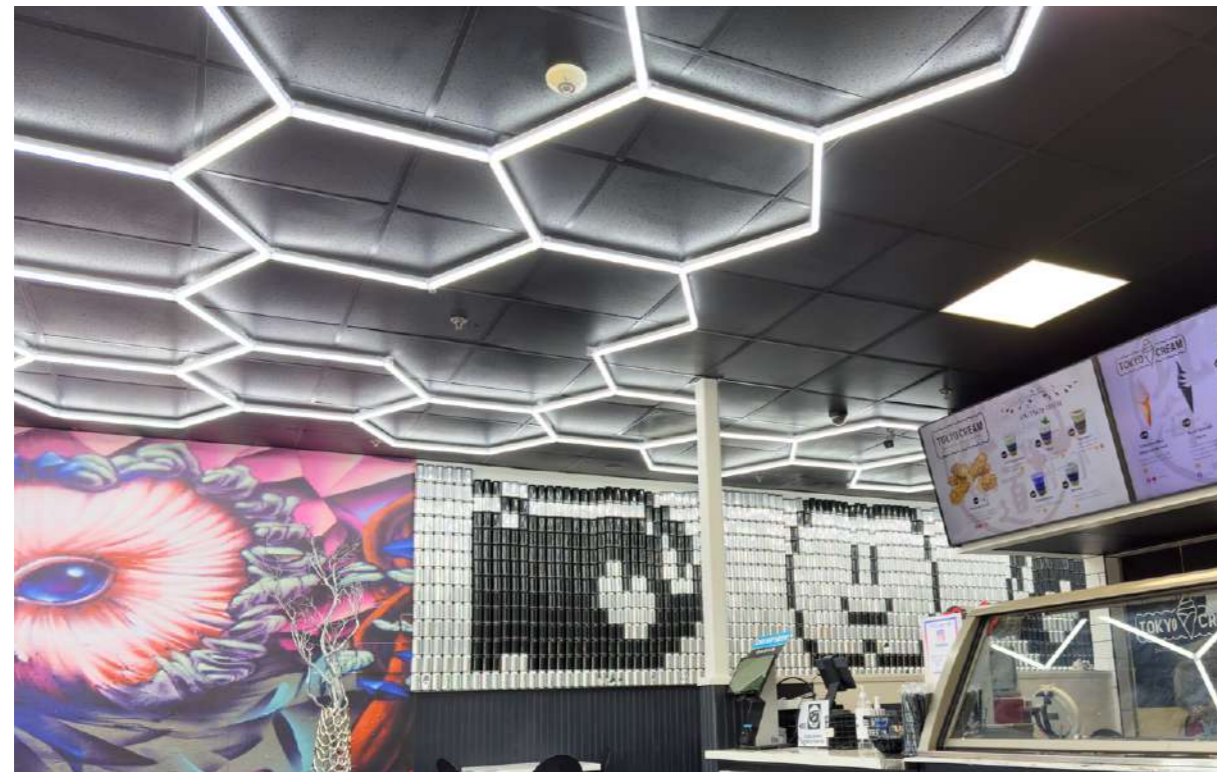

CORPURI LINIARE INTERIOR

INDOOR LINEAR LIGHT

RO

Corpurile liniare LED sunt soluții moderne și eficiente pentru iluminarea uniformă și continuă a diverselor spații interioare. Acestea sunt ideale pentru birouri, holuri, săli de ședință sau orice alte medii care necesită o lumină uniform distribuită și eficiență energetică. Modelele interconectabile și suspendabile permit personalizarea ușoară a configurațiilor pentru a se potrivi perfect cu nevoile fiecărui spațiu, iar tehnologia LED asigură un consum redus și o durabilitate îndelungată.

REPERE

- **Configurabilitate ridicată** - modelele interconectabile și kiturile de montaj suspendat permit o adaptare flexibilă la diverse nevoi de iluminat;
- **Design minimalist** - aspect subțire și discret, ușor de integrat în orice stil de decor modern;
- **Tehnologie LED** - iluminare eficientă energetică, cu o durată de viață prelungită și o performanță constantă.

EN

Linear LED lighting fixtures are modern and efficient solutions for uniform and continuous lighting of various indoor spaces. These are ideal for offices, hallways, meeting rooms, or any other environments that require uniformly distributed and energy-efficient light. Interconnecting and suspended models allow for easy customization of configurations to perfectly match the needs of each space, and LED technology ensures low consumption and long durability.

FEATURES

- **High configurability** - interconnecting models and suspended mounting kits allow flexible adaptation to various lighting needs;
- **Minimalist design** - slim and discreet appearance, easy to integrate into any modern decor style;
- **LED technology** - energy-efficient lighting with extended lifespan and consistent performance.

LED IP40 230V

| RO | Cod | Denumire | Putere | Temp. culoare | Flux luminos | Dispensar | Dimensiune | Material | Interconectabil |
|----|------|----------|--------|---------------|---------------|-----------|------------|----------|------------------|
| EN | Code | Name | Power | Color temp. | Luminous flux | Diffuser | Size | Material | Interconnectable |

NOVELITE - CORPURI LINIARE INTERCONECTABILE LED HEXAGONALE / HONEYCOMB INTERCONNECTABLE LINEAR LED FIXTURES

| | | | | | | | | | |
|-----------|---|----|-------|-------|------|-------------|----|--------------------------------|--|
| EL0085003 | Corp Liniar T5 LED Interconectabil HEXANET / HEXANET Honeycomb T5 LED Linear Fixture | 8W | 4000K | 880lm | Opal | 440x36x22mm | PC | Da, max. 800W / Yes, 800W max. | |
| EL0085005 | Conector 120° HEXANET / 120° HEXANET connector | | | | | | | | |
| EL0085004 | Conector 180° HEXANET / 180° HEXANET connector | | | | | | | | |
| EL0085006 | Conector 90° HEXANET / 90° HEXANET connector | | | | | | | | |
| EL0085008 | Conector T HEXANET / HEXANET T connector | | | | | | | | |
| EL0085007 | Conector Y HEXANET / HEXANET Y connector | | | | | | | | |
| EL0085009 | Cablul alimentare HEXANET 1,5m 2x0.75mm ² / HEXANET power cable 1.5m 2x0.75mm ² | | | | | | | | |
| EL0085010 | Kit suspendare HEXANET 2m / HEXANET suspension kit 2m | | | | | | | | |

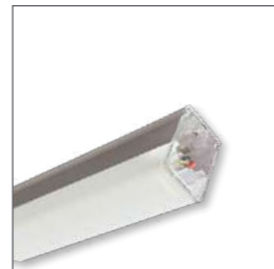

EL0085003

6500°K IP20 230V

| RO | Cod | Denumire | Montaj | Source | Alimentare tub | Putere | Flux luminos | Lungime |
|----|------|----------|----------|--------|-------------------------------|--------|---------------|---------|
| EN | Code | Name | Mounting | Source | LED tube power supply circuit | Power | Luminous flux | Length |

HOMELIGHT - CORPURI JB LED / JB LED LIGHT

| | | | | | | | |
|-----------|----------------------------|----|---------|-------------------------|-------|--------|--------|
| EL0080967 | Corp JB LED / JB LED light | PT | Tub LED | 2 capete / 2-End supply | 1x9W | 630lm | 600mm |
| EL0080968 | | | | | 2x9W | 1260lm | |
| EL0060102 | | | | | 1x18W | | 1200mm |
| EL0040004 | | | | | 2x18W | 2520lm | |

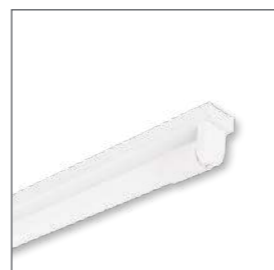

Corp JB LED Homelight / Homelight JB LED light

IP20 230V

| RO | Cod | Denumire | Montaj | Source | Alimentare tub | Putere | Temperatură culoare | Flux luminos | Lungime |
|----|------|----------|----------|--------|-------------------------------|--------|---------------------|---------------|---------|
| EN | Code | Name | Mounting | Source | LED tube power supply circuit | Power | Color temperature | Luminous flux | Length |

NOVELITE - CORPURI JB LED / JB LED LIGHT

| | | | | | | | | |
|-----------|----------------------------|----|---------|-------------------------|-------|-------|--------|--------|
| EL0032652 | Corp JB LED / JB LED light | PT | Tub LED | 2 capete / 2-End supply | 1x18W | 4000K | 1620lm | 1200mm |
| EL0032651 | | | | | 1x18W | 6500K | 1620lm | |
| EL0032654 | | | | | 2x18W | 4000K | 3240lm | |
| EL0032653 | | | | | 2x18W | 6500K | 3240lm | |
| EL0032650 | | | | | 2x8W | 4000K | 1440lm | 600mm |
| EL0032649 | | | | | 2x8W | 6500K | 1440lm | |
| EL0032648 | | | | | 1x8W | 4000K | 720lm | |
| EL0032647 | | | | | 1x8W | 6500K | 720lm | |



Corp JB LED Novelite / Novelite JB LED light

LED IP40 230V

| RO | Cod | Denumire | Montaj | Putere | Temperată culoare | Flux luminos | Dimensiune | Material | Culoare |
|----|------|----------|----------|--------|-------------------|---------------|------------|----------|---------|
| EN | Code | Name | Mounting | Power | Color temperature | Luminous flux | Size | Material | Color |

NOVELITE - CORP LED COLȚ / ROUND CORNER LED LIGHT

| | | | | | | | | |
|-----------|----------------------------------|----|------|-------|--------|--------------|--------------------------------|-------------|
| EL0075606 | Corp LED colț / Corner LED light | PT | 100W | 6400K | 1000lm | 501x122x79mm | Aluminiu + PC / Aluminium + PC | Alb / White |
|-----------|----------------------------------|----|------|-------|--------|--------------|--------------------------------|-------------|



Corp LED colț Novelite / Novelite Corner LED Light

LED 4000°K IP44 230V

| RO | Cod | Denumire | Montaj | Putere | Flux luminos | Dispersor | Dimensiune | Material | Interconectabil |
|----|------|----------|----------|--------|---------------|-----------|------------|----------|-----------------|
| EN | Code | Name | Mounting | Power | Luminous flux | Diffuser | Size | Material | Interconnected |

NOVELITE - CORPURI LINIARE INTERCONECTABILE LED / INTERCONNECTABLE LINEAR LED LIGHT

| | | | | | | | | | | | | |
|-----------|---|-------------------------------|------|---------|---|--------|--------------|----------------------------------|---|---|---|---|
| EL0076584 | Corp liniar LED interconectabil / Interconnectable linear LED light | PT/ Suspendat / PT/ Suspended | Opal | PC + Al | 30W | 3600lm | 900x50x55mm | Da, max. 1000W / Yes, 1000W max. | | | | |
| EL0076589 | | | | | 40W | 4800lm | 1200x50x55mm | | | | | |
| EL0076592 | | | | | 50W | 6000lm | 1500x50x55mm | | | | | |
| EL0076610 | | | | | 8W | 960lm | 181x181x58mm | | | | | |
| EL0076607 | | | | | 10W | 1200lm | 181x116x58mm | | | | | |
| EL0076603 | | | | | 10W | 1200lm | 116x116x58mm | | | | | |
| EL0076611 | | | | | Kit montaj suspendat / Suspended mounting Kit | - | - | | - | - | - | - |
| EL0076612 | | | | | Cablu alimentare / Power cable | - | - | | - | - | - | - |



EL0076584



EL0076610



EL0076607



EL0076603



EL0076611



EL0076612

LED IP20 230V

| RO | Cod | Denumire | Montaj | Putere | Temperatură culoare | Flux luminos | Grad de protecție | Dispersor | Dimensiune | Material |
|----|------|----------|----------|--------|---------------------|---------------|---------------------------|-----------|------------|----------|
| EN | Code | Name | Mounting | Power | Color temperature | Luminous flux | Ingress protection rating | Diffuser | Size | Material |

HOMELIGHT - CORPURI LINIARE LT103 LED / LT103 LED LINEAR FIXTURE

| | | | | | | | | | |
|-----------|--|----|-----|-------|--------|------|------|--------------|----|
| EL0040033 | Corp liniar LT103 LED / LT103 LED Linear Fixture | PT | 36W | 6400K | 2880lm | IP20 | Opal | 1200x75x26mm | PP |
| EL0040032 | | | 18W | | 1440lm | | | 600x75x26mm | |



Corp liniar LT103 LED Homelight / Homelight LT103 LED linear fixture

LED 230V

NOVELITE - CORPURI LINIARE LT103 LED / LT103 LED LINEAR FIXTURE

| | | | | | | | | | |
|-----------|--|----|-----|-------|--------|------|------|--------------|-----------------|
| EL0075819 | Corp liniar LT103 LED v1 / LT103 LED linear fixture v1 | PT | 72W | 6400K | 5760lm | IP40 | Opal | 1200x75x26mm | Metal + PC + PP |
| EL0075818 | | | 54W | | 4320lm | | | 1200x75x26mm | |
| EL0032044 | | | 40W | | 3200lm | | | 1200x75x26mm | |
| EL0032043 | Corp liniar LT103 LED v2 / LT103 LED linear fixture v2 | PT | 20W | 6400K | 1600lm | IP40 | Opal | 600x75x26mm | Metal + PC + PP |
| EL0059582 | | | 40W | | 2800lm | | | 600x75x26mm | |
| EL0059581 | | | 20W | | 1400lm | | | 600x75x26mm | |
| EL0059580 | Corp liniar LT103 LED v3 / LT103 LED linear fixture v3 | PT | 10W | 6400K | 700lm | IP20 | Opal | 300x75x26mm | AI + PC |
| EL0083475 | | | 54W | | 5184lm | | | 1200x75x25mm | |
| EL0083474 | | | 36W | | 3240lm | | | 1200x75x25mm | |
| EL0083473 | | | 18W | | 1620lm | | | 600x75x25mm | |



Corp liniar ILT103 LED Novelite / Novelite LT103 LED linear fixture

LED IP44 230V

| RO | Cod | Denumire | Montaj | Putere | Temperatură culoare | Flux luminos | Dispersor | Dimensiune | Material |
|----|------|----------|----------|--------|---------------------|---------------|-----------|------------|----------|
| EN | Code | Name | Mounting | Power | Color temperature | Luminous flux | Diffuser | Size | Material |

NOVELITE - CORPURI LINIARE LT105 LED / LT105 LED LINEAR FIXTURE

| | | | | | | | | |
|-----------|--|----|-----|-------|--------|------|---------------|------------|
| EL0075825 | Corp liniar LT105 LED / LT105 LED linear fixture | PT | 20W | 6400K | 1800lm | Opal | 595x155x62mm | |
| EL0075826 | | | 40W | | 3600lm | | 1200x155x62mm | Metal + PC |
| EL0075827 | | | 50W | | 4500lm | | 1200x155x62mm | |



Corp liniar LT105 LED Novelite / Novelite LT105 LED linear fixture

LED IP20 230V

HOMELIGHT - CORPURI LINIARE LT106 LED / LT106 LED LINEAR FIXTURE

| | | | | | | | | |
|-----------|--|----|-----|-------|--------|-----------|---------------|------------|
| EL0081216 | Corp liniar LT106 LED / LT106 LED linear fixture | PT | 36W | 6500K | 2520lm | Prismatic | 1245x130x55mm | Metal + PC |
| EL0080969 | | | 18W | | 1260lm | | 645x130x55mm | |



Corp liniar LT106 LED Homelight / Homelight LT106 LED linear fixture

LED IP40 230V

HOMELIGHT - CORPURI LINIARE LT110 LED / LT110 LED LINEAR FIXTURE

| | | | | | | | | |
|-----------|--|----|------|-------|--------|-----------|--------------|-----------------|
| EL0075820 | Corp liniar LT110 LED / LT110 LED linear fixture | PT | 20W | 6400K | 1700lm | Prismatic | 600x62x25mm | |
| EL0075821 | | | 40W | | 3400lm | | 1200x62x25mm | |
| EL0075822 | | | 54W | | 4590lm | | 1200x62x25mm | Metal + PP + PS |
| EL0075823 | | | 72W | | 6120lm | | 1200x73x25mm | |
| EL0075824 | | | 100W | | 8500lm | | 1200x73x25mm | |



Corp liniar LT110 LED Homelight / Novelite LT110 LED linear fixture

LED IP44 230V

| RO | Cod | Denumire | Montaj | Putere | Temperatură culoare | Flux luminos | Dispersor | Dimensiune | Material |
|----|------|----------|----------|--------|---------------------|---------------|-----------|------------|----------|
| EN | Code | Name | Mounting | Power | Color temperature | Luminous flux | Diffuser | Size | Material |

NOVELITE - CORPURI LINIARE LT106 LED / LT106 LED LINEAR FIXTURE

| | | | | | | | | | |
|-----------|--|----|-----|-------|--------|-----------|-------------------------|---------------|---------------|
| EL0075828 | Corp liniar LT106 LED v1 / LT106 LED linear fixture v1 | PT | 80W | 6400K | 6400lm | Prismatic | Metal + PS / Metal + PS | 1240x130x52mm | |
| EL0032046 | | | 40W | | | | | 3200lm | 1240x130x52mm |
| EL0032045 | | | 20W | | | | | 800lm | 600x130x52mm |
| EL0083273 | | | 36W | | | | | 3240lm | 1240x175x64mm |
| EL0083272 | Corp liniar LT106 LED v2 / LT106 LED linear fixture v2 | | 18W | | 1620lm | | | 630x175x64mm | |



Corp liniar LT106 LED Novelite / Novelite LT106 LED linear fixture

LED IP44 230V

HOMELIGHT - CORPURI LINIARE LT111 LED / LT111 LED LINEAR FIXTURE

| | | | | | | | | | |
|-----------|--|----|------|-------|--------|-------------|-----------------------------------|--------------|--------------|
| EL0075829 | Corp liniar LT111 LED v1 / LT111 LED linear fixture v1 | PT | 27W | 6400K | 2430lm | Transparent | Metal + PP + PS / Metal + PP + PS | 600x75x22mm | |
| EL0075830 | | | 54W | | | | | 4860lm | 1200x75x22mm |
| EL0075831 | | | 100W | | | | | 9000lm | 1200x75x22mm |
| EL0084332 | | | 27W | | | | | 2430lm | 600x57x22mm |
| EL0084684 | Corp liniar LT111 LED v2 / LT111 LED linear fixture v2 | | 54W | | 4860lm | | | 1200x57x22mm | |
| EL0084383 | | | 100W | | 9000lm | | | 1200x95x22mm | |



Corp liniar LT111 LED Homelight / Homelight LT111 LED linear fixture

LED IP20 230V

| RO | Cod | Denumire | Montaj | Sursă | Putere | Temperatură culoare | Flux luminos | Tub inclus | Dimensiune | Material |
|----|------|----------|----------|--------|--------|---------------------|---------------|---------------|------------|----------|
| EN | Code | Name | Mounting | Source | Power | Color temperature | Luminous flux | Included tube | Size | Material |

NOVELITE - CORPURI T5 FLUORESCENT / T5 FLUORESCENT LINEAR FIXTURE

| | | | | | | | | | |
|-----------|--|----|------------------------------------|-------|-------|----------|-------|---------|-------------|
| EL0039160 | Corp liniar fluorescent T5 VELDI / VELDI T5 fluorescent linear fixture | PT | Tub Fluorescent / Fluorescent tube | 1x6W | 6400K | Da / Yes | 180lm | AI + PC | 268x22x44mm |
| EL0037108 | | | | 1x8W | | | 240lm | | 345x22x44mm |
| EL0037109 | | | | 1x21W | | | 630lm | | 900x22x42mm |



Corp liniar fluorescent T5 VELDI Novelite / Novelite VELDI T5 fluorescent linear fixture

LED IP20 230V

| RO | Cod | Denumire | Montaj | Putere | Temperatură culoare | Flux luminos | Dispersor | Material | Dimensiune | Interconectabil |
|----|------|----------|----------|--------|---------------------|---------------|-----------|----------|------------|-----------------|
| EN | Code | Name | Mounting | Power | Color temperature | Luminous flux | Diffuser | Material | Size | Interconnected |

NOVELITE - CORPURI T5 LED / T5 LED LINEAR FIXTURE

| | | | | | | | | | | |
|-----------|---|----|-----|-------|--------|------|-----|----------|-------------|--------------|
| EL0037735 | Corp liniar LED T5 interconectabil v1 / Interconnectable T5 LED linear fixture v1 | PT | 5W | 6500K | 1200lm | Opal | PVC | Max. 75W | 305x21x36mm | |
| EL0037737 | | | 9W | | | | | | 720lm | 570x21x36mm |
| EL0037738 | | | 12W | | | | | | 960lm | 874x21x36mm |
| EL0037739 | | | 15W | | | | | | 1200lm | 1175x21x36mm |
| EL0085312 | Corp liniar LED T5 interconectabil v2 / Interconnectable T5 LED linear fixture v2 | | 5W | | 625lm | | | | 305x21x36mm | |
| EL0085313 | | | 9W | | | | | | 1125lm | 570x21x36mm |
| EL0085311 | | | 15W | | | | | | 1875lm | 1175x21x36mm |



Corp liniar LED T5 interconectabil Novelite / Novelite interconectabil T5 LED linear fixture



PANOURI LED

LED PANELS

RO

Panourile de iluminat sunt soluții moderne, ideale pentru iluminarea uniformă a spațiilor interioare mari, precum birouri, clădiri comerciale, săli de conferințe sau unități industriale. Acestea oferă un iluminat eficient, reducând oboseala vizuală și îmbunătățind confortul ambiantal.

REPERE

- **Tehnologie LED avansată** – consum redus de energie, durată lungă de viață și costuri minime de întreținere;
- **Iluminare uniformă** – distribuție echilibrată a luminii, fără zone de umbră, pentru un mediu de lucru confortabil;
- **Durabilitate** – construite din materiale rezistente, ideale pentru utilizare îndelungată.

EN

Panel lights are modern solutions, ideal for uniform illumination of large indoor spaces, such as offices, commercial buildings, conference rooms or industrial units. They provide efficient lighting, reducing visual fatigue and improving environmental comfort.

FEATURES

- **Advanced LED technology** – low energy consumption, long life and minimal maintenance costs;
- **Uniform lighting** – balanced light distribution, without shadow areas, for a comfortable working environment;
- **Durability** – constructed of durable materials, ideal for long-term use.

RO

| Cod | Denumire | Formă | Montaj | Putere | Flux luminos | Dimensiune | Dimensiune decupaj | Material | Culoare |
|-----|----------|-------|--------|--------|--------------|------------|--------------------|----------|---------|
|-----|----------|-------|--------|--------|--------------|------------|--------------------|----------|---------|

EN

| Code | Name | Shape | Mounting | Power | Luminous flux | Size | Cut-out dimensions | Material | Color |
|------|------|-------|----------|-------|---------------|------|--------------------|----------|-------|
|------|------|-------|----------|-------|---------------|------|--------------------|----------|-------|

HOMELIGHT - MINI PANOURI LED / MINI LED PANELS

| | | | | | | | | | | |
|-----------|------------------------------------|--------------------|-----|--------|-------------|----------------|-----------|---------|----------------|---|
| EL0076008 | Mini Panou LED / Mini LED panel | Pătrat / Square | PT | 12W | 1020lm | 173x173x35mm | - | Plastic | Alb / White | |
| EL0076009 | | | | 20W | 1700lm | 226x226x35mm | - | | | |
| EL0076010 | | | | 24W | 2040lm | 289x289x35mm | - | | | |
| EL0076001 | | | ST | 6W | 510lm | 120x120x26.5mm | 95-100mm | | | |
| EL0076002 | | | | 12W | 1020lm | 175x175x26.5mm | 140-150mm | | | |
| EL0076003 | | | | 20W | 1700lm | 218x218x27.5mm | 190-200mm | | | |
| EL0076004 | | | | 24W | 2040lm | 289x289x30mm | 275-285mm | | | |
| EL0076005 | | | | PT | 12W | 1020lm | ∅174x35mm | | | - |
| EL0076006 | | | | | 20W | 1700lm | ∅226x35mm | | | - |
| EL0076007 | | | 24W | | 2040lm | ∅289x38mm | - | | | |
| EL0075996 | Rotund / Round | ST | 6W | 510lm | ∅118x22.5mm | ∅95-100mm | | | | |
| EL0075998 | | | 12W | 1020lm | ∅175x26.5mm | ∅140-150mm | | | | |
| EL0075999 | | | 20W | 1700lm | ∅218x27.5mm | ∅190-200mm | | | | |
| EL0076000 | | PT | 24W | 2040lm | ∅289x30mm | ∅275-285mm | | | | |



Mini Panou LED PT pătrat /
Mini square PT LED panel

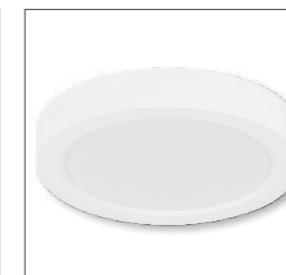

Mini Panou LED PT rotund /
Mini round PT LED panel



Mini Panou LED ST pătrat /
Mini square ST LED panel



Mini Panou LED ST rotund /
Mini round ST LED panel



| RO | Cod | Denumire | Formă | Montaj | Putere | Flux luminos | Temperatură culoare | Dimensiune | Material | Culoare |
|----|------|----------|-------|----------|--------|---------------|---------------------|------------|----------|---------|
| EN | Code | Name | Shape | Mounting | Power | Luminous flux | Color temperature | Size | Material | Color |

NOVELITE - MINI PANOURI LED / MINI LED PANELS

| | | | | | | | | | | | |
|-----------|-----------------------------------|--------------------|----|--------|--------|-------------------|--------------|----------------|--------|------------------|-----------|
| EL0027499 | Mini panou LED/ Mini LED panel | Pătrat / Square | PT | AI+ PC | 20W | 2700K | 210x210x28mm | Alb / White | | | |
| EL0035826 | | | | | | 1400lm | | | 4000K | | |
| EL0027498 | | | | | | 6400K | | | | | |
| EL0075358 | | | | | | 1600lm | | | | | |
| EL0035828 | | | | | | 2700K | | | | | |
| EL0035829 | | | | | | 1680lm | | | 4000K | | |
| EL0035827 | | | | | 6400K | | | | | | |
| EL0075357 | | | | | 1920lm | Negru / Black | | | | | |
| EL0027497 | | | | | 2700K | Alb / White | | | | | |
| EL0035822 | | | | | 20W | Rotund / Round | PT | AI+ PC | 1400lm | 4000K | ø210x28mm |
| EL0027496 | | | | | | | | | 6400K | | |
| EL0075359 | | | | | | | | | 1600lm | Negru / Black | |
| EL0035824 | 2700K | | | | | | | | | | |
| EL0035825 | 1680lm | 4000K | | | | | | | | | |
| EL0035823 | 6400K | | | | | | | | | | |
| EL0075360 | 1920lm | Negru / Black | | | | | | | | | |

Mini panou LED PT pătrat /
Mini square PT LED panelMini panou LED PT rotund /
Mini round PT LED panel

| RO | Cod | Denumire | Formă | Montaj | Putere | Flux luminos | Temperatură culoare | Dimensiune | Dimensiune decupaj | Material | Culoare |
|----|------|----------|-------|----------|--------|---------------|---------------------|------------|--------------------|----------|---------|
| EN | Code | Name | Shape | Mounting | Power | Luminous flux | Color temperature | Size | Cut-out dimensions | Material | Color |

NOVELITE - MINI PANOURI LED / MINI LED PANELS

| | | | | | | | | | | | | | | | |
|-----------|---|--------------------|----|---------|--------|-------------------|-------------------|------------------|-----------|----------------|--------------|-----------|------------------|--------------|-----------|
| EL0027490 | Mini Panou LED/ Mini LED panel | Pătrat / Square | ST | AI + PC | 6W | 360lm | 2700K | 115x115x15mm | 105x105mm | Alb / White | | | | | |
| EL0027489 | | | | | | 360lm | 6400K | | | | | | | | |
| EL0027492 | | | | | | 12W | 720lm | | | | 2700K | | | | |
| EL0027491 | | | | | | | 6400K | | | | | | | | |
| EL0027494 | | | | | | 20W | Rotund / Round | | | | ST | AI + PC | 2700K | 220x220x15mm | 205x205mm |
| EL0027495 | | | | | | | | | | | | | 4000K | | |
| EL0027493 | | | | | 6400K | | | | | | | | | | |
| EL0075362 | | | | | 1600lm | | | Negru / Black | | | | | | | |
| EL0035820 | | | | | 24W | Rotund / Round | ST | AI + PC | 2700K | | 295x295x15mm | 280x280mm | | | |
| EL0035821 | | | | | | | | | 4000K | | | | | | |
| EL0035819 | | | | | | | | | 6400K | | | | | | |
| EL0075361 | | | | | | | | | 1920lm | | | | Negru / Black | | |
| EL0027483 | 6W | Rotund / Round | ST | AI + PC | | | | | 2700K | ø115x15mm | | | ø105mm | | |
| EL0027482 | | | | | | | | | 6400K | | | | | | |
| EL0027485 | | | | | 12W | 2700K | ø165x15mm | ø155mm | | | | | | | |
| EL0027484 | | | | | | 6400K | | | | | | | | | |
| EL0027487 | | | | | 20W | Rotund / Round | ST | AI + PC | 2700K | | ø220x15mm | ø205mm | | | |
| EL0027488 | | | | | | | | | 4000K | | | | | | |
| EL0027486 | 6400K | | | | | | | | | | | | | | |
| EL0075363 | 1600lm | Negru / Black | | | | | | | | | | | | | |
| EL0035817 | 24W | Rotund / Round | ST | AI + PC | 2700K | ø295x15mm | ø280mm | | | | | | | | |
| EL0035818 | | | | | 4000K | | | | | | | | | | |
| EL0035816 | | | | | 6400K | | | | | | | | | | |
| EL0075364 | | | | | 1920lm | | | Negru / Black | | | | | | | |

Mini panou LED ST pătrat /
Mini square ST LED panelMini panou LED ST rotund /
Mini round ST LED panel



| RO | Cod | Denumire | Formă | Montaj | Putere | Flux luminos | Temperatură culoare | Dimensiune | Material | Culoare |
|----|------|----------|-------|----------|--------|---------------|---------------------|------------|----------|---------|
| EN | Code | Name | Shape | Mounting | Power | Luminous flux | Color temperature | Size | Material | Color |

HOMELIGHT - MINI PANOURI LED TIP FAGURE / MINI HONEYCOMB LED PANELS

| | | | | | | | | | | |
|-----------|---------------------------------|----------------|--|----|-----|--------|-------|-----------|------------|-------------|
| EL0086011 | | | | | 16W | 1600lm | | 120x30mm | | |
| EL0086012 | | | | PT | 22W | 2200lm | | 170x30mm | | |
| EL0086014 | Mini Panou LED / Mini LED Panel | Rotund / Round | | | 32W | 3200lm | 6400K | 220x30mm | Metal + PS | Alb / White |
| EL0086004 | | | | ST | 16W | 1600lm | | 120x14mm* | | |
| EL0086009 | | | | | 22W | 2200lm | | 170x14mm* | | |

i *Dimensiune reglabilă decupaj / Adjustable Cut-out dimensions: ø55-95mm / ø55-150mm



Varianta PT / PT version



Varianta ST / ST version



| RO | Cod | Denumire | Formă | Montaj | Putere | Flux luminos | Temperatură culoare | Dimensiune | Material | Culoare |
|----|------|----------|-------|----------|--------|---------------|---------------------|------------|----------|---------|
| EN | Code | Name | Shape | Mounting | Power | Luminous flux | Color temperature | Size | Material | Color |

HOMELIGHT - MINI PANOURI LED TIP FAGURE / MINI HONEYCOMB LED PANELS

| | | | | | | | | | | |
|-----------|---------------------------------|-----------------|--|----|-----|--------|-------|--------------|------------|-------------|
| EL0086015 | Mini Panou LED / Mini LED Panel | Pătrat / Square | | PT | 22W | 2200lm | 6400K | 170x170x30mm | Metal + PS | Alb / White |
| EL0086016 | | | | | 32W | 3200lm | | 220x220x30mm | | |



Mini Panou LED hexagonal / Mini Hexagon LED Panel



| RO | Cod | Denumire | Formă | Montaj | Putere | Flux luminos | Temperatură culoare | Dimensiune | Material | Culoare |
|----|------|----------|-------|----------|--------|---------------|---------------------|------------|----------|---------|
| EN | Code | Name | Shape | Mounting | Power | Luminous flux | Color temperature | Size | Material | Color |

HOMELIGHT - MINI PANOURI LED RETRO / MINI LED RETRO PANELS

| | | | | | | | | | | |
|-----------|---------------------------------|----------------|--|----|-----|--------|-------|----------|-------|-------------|
| EL0086020 | Mini Panou LED / Mini LED panel | Rotund / Round | | PT | 18W | 1800lm | 6400K | 180x55mm | Al+PC | Alb / White |
| EL0086023 | | | | | 24W | 2400lm | | 220x55mm | | |



Varianta retro PT / Retro PT version



| RO | Cod | Denumire | Formă | Montaj | Putere | Flux luminos | Temperatură culoare | Dimensiune | Material | Culoare |
|----|------|----------|-------|----------|--------|---------------|---------------------|------------|----------|---------|
| EN | Code | Name | Shape | Mounting | Power | Luminous flux | Color temperature | Size | Material | Color |

HOMELIGHT - MINI PANOURI LED RETRO / MINI LED RETRO PANELS

| | | | | | | | | | | |
|-----------|---------------------------------|-----------------|--|----|-----|--------|-------|--------------|-------|-------------|
| EL0086018 | Mini Panou LED / Mini LED panel | Pătrat / Square | | PT | 18W | 1800lm | 6400K | 180x180x55mm | Al+PC | Alb / White |
| EL0086019 | | | | | 24W | 2400lm | | 220x220x55mm | | |



Mini retro Panou LED / Mini retro LED panel



| RO | Cod | Denumire | Formă | Montaj | Putere | Flux luminos | Temperatură culoare | Dimensiune produs | Dimensiune decupaj | Material | Culoare |
|----|------|----------|-------|----------|--------|---------------|---------------------|-------------------|--------------------|----------|---------|
| EN | Code | Name | Shape | Mounting | Power | Luminous flux | Color temperature | Product size | Cut-out dimensions | Material | Color |

NOVELITE - MINI PANOURI LED / MINI LED PANELS

| | | | | | | | | | | |
|-----------|---|----------------|-------|-----|--------|-----|----------|----------|--------------|---------------|
| EL0075001 | Mini panou LED cu senzor de mișcare / Mini LED panel with motion detection sensor | Rotund / Round | PT/ST | 18W | 1620lm | CCT | 230x20mm | 55-185mm | Plastic + PC | Alb / White |
| EL0075002 | | | | | | | | | | Negru / Black |



EL0075001



EL0075002



| RO | Cod | Denumire | Formă | Montaj | Putere | Flux luminos | Temperatură culoare | Dimensiune | Material | Culoare |
|----|------|----------|-------|----------|--------|---------------|---------------------|------------|----------|---------|
| EN | Code | Name | Shape | Mounting | Power | Luminous flux | Color temperature | Size | Material | Color |

NOVELITE - MINI PANOURI LED / MINI LED PANELS

| | | | | | | | | | | |
|-----------|---------------------------------|---|----|-----|--------|--|--|--------------|----------------------------|-------------|
| EL0068060 | Fagure rotund / Round honeycomb | | | 15W | 1200lm | | | ø319x35mm | | |
| EL0068061 | Mini panou LED / Mini LED panel | Fagure pătrat / Square honeycomb | PT | 15W | 6400K | | | 316x316x35mm | ABS + Sticlă / ABS + Glass | Alb / White |
| EL0068062 | | Fagure dreptunghi / Rectangular honeycomb | | 22W | 1760lm | | | 565x260x42mm | | |



EL0068062



EL0068061



EL0068060



| RO | Cod | Denumire | Tip panou | Montaj | Putere | Flux luminos | Temperatură culoare | Dimensiune | Material | Culoare |
|----|------|----------|------------|----------|--------|---------------|---------------------|------------|----------|---------|
| EN | Code | Name | Panel type | Mounting | Power | Luminous flux | Color temperature | Size | Material | Color |

HOMELIGHT - PANOURI LED BACKLIT / LED BACKLIT PANELS

| | | | | | | | | | | |
|-----------|---|--|---------|----|-----|--------|-------|--------------|-----------------|-------------|
| EL0072417 | Set 10 panouri LED Backlit / Set of 10 backlit LED panels | | | | 40W | 3800lm | | 595x595x30mm | | |
| EL0075638 | | | | | 36W | 3240lm | 6400K | 595x595x34mm | Al + PS | |
| EL0060088 | Set 2 panouri LED backlit / Set of 2 backlit LED panels | | Backlit | ST | 48W | 3600lm | 6500K | 595x595x30mm | Al + Metal + PC | Alb / White |
| EL0080964 | Panou LED backlit / LED backlit panel | | | | 40W | | 6400K | | Metal + PS | |

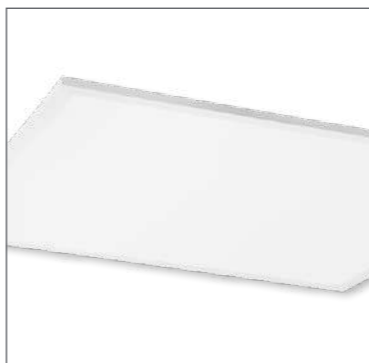

Panou LED / LED panel



NOVELITE - PANOURI LED BACKLIT / LED BACKLIT PANELS

| | | | | | | | | | | |
|-----------|---|--|--|----|-----|--------|-------|---------------|-----------------|-------------|
| EL0057451 | Set 2 panouri LED backlit / Set of 2 backlit LED panels | | | ST | 48W | 3360lm | 6500K | 595x595x27mm | Al + Metal + PC | Alb / White |
| EL0059591 | Panou LED backlit / LED backlit panel | | | ST | 48W | 3360lm | 6400K | 295x1195x39mm | | |

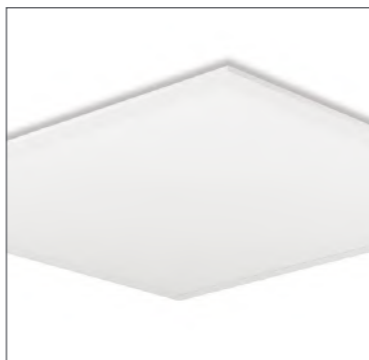

Panou LED / LED panel



| RO | Cod | Denumire | Tip panou | Montaj | Putere | Factor UGR | Flux luminos | Temperatură culoare | Dimensiune | Material | Culoare |
|----|------|----------|------------|----------|--------|------------|---------------|---------------------|------------|----------|---------|
| EN | Code | Name | Panel type | Mounting | Power | Factor UGR | Luminous flux | Color temperature | Size | Material | Color |

SOLENTIS - PANOURI LED BACKLIT / LED BACKLIT PANELS

| | | | | | | | | | | |
|-----------|---------------------------------------|---------|----|-----|--------|--------|-------|---------------|------------------------|-------------|
| EL0071845 | Panou LED Backlit / LED backlit panel | Backlit | ST | 40W | UGR>22 | 4200lm | 6400K | 295x1195x28mm | Oțel + PC / Steel + PC | Alb / White |
| EL0071843 | | | | | | | 4000K | 595x595x24mm | Oțel + PC / Steel + PC | |
| EL0084262 | | | | | | | 28W | UGR<19 | AI + PC | |

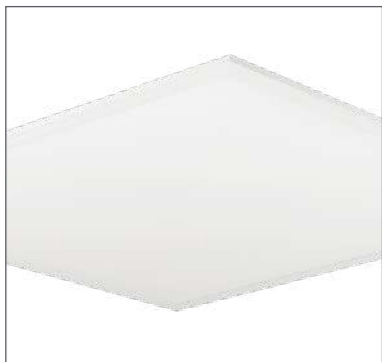

Panou LED Backlit Solentis / Solentis LED backlit panel



| RO | Cod | Denumire | Tip panou | Montaj | Putere | Flux luminos | Grad de protecție | Temperatură culoare | Dimensiune | Material | Culoare |
|----|------|----------|------------|----------|--------|---------------|---------------------------|---------------------|------------|----------|---------|
| EN | Code | Name | Panel type | Mounting | Power | Luminous flux | Ingress protection rating | Color temperature | Size | Material | Color |

NOVELITE - PANOURI LED IP44/IP65 / IP44/IP65 LED PANEL

| | | | | | | | | | | |
|-----------|---------------------------------|---------|----|-----|--------|------|-------|--------------|-----------------|-------------|
| EL0075365 | Panou LED IP44 / IP44 LED panel | Backlit | ST | 72W | 6480lm | IP44 | 6400K | 595x595x21mm | AI + Metal + PC | Alb / White |
| EL0075607 | | | | | | | | 90W | | |
| EL0071368 | Panou LED IP65 / IP65 LED panel | Slim | | 40W | 4000lm | IP65 | 4000K | 595x595x9mm | | |

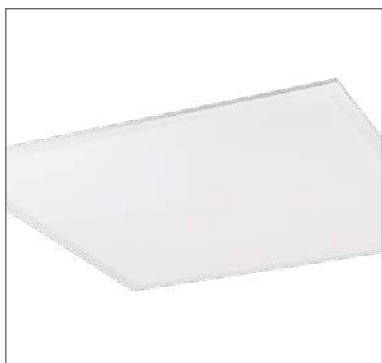

Panou LED Backlit Solentis / Novelite LED backlit panel



| RO | Cod | Denumire | Tip panou | Montaj | Putere | Flux luminos | Temperatură culoare | Dimensiune | Material | Culoare |
|----|------|----------|------------|----------|--------|---------------|---------------------|------------|----------|---------|
| EN | Code | Name | Panel type | Mounting | Power | Luminous flux | Color temperature | Size | Material | Color |

NOVELITE - PANOURI LED APLICAT / SURFACE-MOUNTED LED PANEL

| | | | | | | | | | |
|-----------|-----------------------------|---------|----|-----|--------|-------|---------------|---------|-------------|
| EL0068771 | Panou LED PT / PT LED panel | Backlit | PT | 50W | 5250lm | 4000K | 595x595x45mm | AI + PC | Alb / White |
| EL0068781 | | | | | | 6400K | | | |
| EL0068786 | | | | | | 4000K | 295x1195x45mm | | |
| EL0068788 | | | | | | 6400K | | | |



Panou LED Backlit Novelite / Novelite LED backlit panel



| RO | Cod | Denumire | Tip panou | Montaj | Putere | Flux luminos | Temp. culoare | Dimensiune produs | Material | Culoare |
|----|------|----------|------------|----------|--------|---------------|-------------------|-------------------|----------|---------|
| EN | Code | Name | Panel type | Mounting | Power | Luminous flux | Color temperature | Size | Material | Color |

HOMELIGHT - PANOURI LED SLIM / SLIM LED PANELS

| | | | | | | | | | |
|-----------|---------------------------------|------|----|-----|--------|-------|-------------|---------|-------------|
| EL0080965 | Panou LED slim / Slim LED panel | Slim | ST | 40W | 2800lm | 6400K | 595x595x8mm | AI + PS | Alb / White |
| EL0080966 | | | | | | | | | |



Panou LED slim Homelight / Homelight slim LED panel



| RO | Cod | Denumire | Tip panou | Montaj | Putere | Flux luminos | Temperatură culoare | Dimensiune | Material | Culoare |
|----|------|----------|------------|----------|--------|---------------|---------------------|------------|----------|---------|
| EN | Code | Name | Panel type | Mounting | Power | Luminous flux | Color temperature | Size | Material | Color |

NOVELITE - PANOURI LED SLIM / SLIM LED PANELS

| | | | | | | | | | | | | | |
|-----------|---------------------------------|--------|-------|-------------|-------------------|--------|-------|--------------|-------------------|--|-------|--------------|-------------------|
| EL0032593 | Panou LED slim / Slim LED panel | Slim | ST | Al + PC | 48W | 3360lm | 6400K | 595x595x8mm | Argintiu / Silver | | | | |
| EL0036006 | | | | | | | 4000K | 595x595x8mm | | | | | |
| EL0032594 | | | | | | | 3000K | 295x595x9mm | | | | | |
| EL0032589 | | | | | | | 6400K | 595x595x8mm | | | | | |
| EL0032590 | | | | | | | 3000K | | | | | | |
| EL0037064 | | | | | | | 6400K | 295x595x9mm | | | | | |
| EL0068636 | | | | | | | 4000K | | | | | | |
| EL0037065 | | | | | | | 3000K | 595x595x8mm | | | | | |
| EL0084261 | | | | | | | 36W | 2520lm | | | 6400K | 295x1195x8mm | Alb / White |
| EL0032595 | | | | | | | 48W | 3360lm | | | | | |
| EL0032591 | | | | | | | 36W | 2520lm | | | 6400K | 295x1195x9mm | Argintiu / Silver |
| EL0037068 | | | | | | | 48W | 3360lm | | | 4000K | | |
| EL0059362 | | | | | | | 3000K | 295x1195x8mm | | | | | |
| EL0037069 | | | | | | | 3000K | | | | | | |
| EL0083271 | | | | | | | 36W | 2520lm | | | 6400K | 295x595x8mm | Argintiu / Silver |
| EL0032587 | | | | | | | 3000K | | | | | | |
| EL0032588 | | | | | | | 24W | 1680lm | | | 6400K | 295x595x9mm | Alb / White |
| EL0037067 | | | | | | | 4000K | | | | | | |
| EL0059361 | | | | | | | 3000K | 295x595x8mm | | | | | |
| EL0037066 | | | | | | | 3000K | | | | | | |
| EL0032585 | 20W | 1400lm | 6400K | 295x295x8mm | Argintiu / Silver | | | | | | | | |
| EL0032586 | 3000K | | | | | | | | | | | | |



Panou LED Slim Pătrat Argintiu / Slim square silver LED panel



Panou LED Slim Pătrat Alb / Slim square white LED panel



Panou LED Slim Dreptunghiular Argintiu / Slim rectangular silver LED panel



| RO | Cod | Denumire | Tip panou | Montaj | Putere | Flux luminos | Temperatură culoare | Dimensiune | Material | Culoare |
|----|------|----------|------------|----------|--------|---------------|---------------------|------------|----------|---------|
| EN | Code | Name | Panel type | Mounting | Power | Luminous flux | Color temperature | Size | Material | Color |

SOLENTIS - PANOURI LED SLIM / SLIM LED PANELS

| | | | | | | | | | |
|-----------|---------------------------------|------|----|-----|--------|-------|--------------|---------|-------------|
| EL0067702 | Panou LED slim / Slim LED panel | Slim | ST | 40W | 4400lm | 4000K | 595x595x9mm | Al + PC | Alb / White |
| EL0067703 | | | | | | | 295x1195x9mm | | |
| EL0067704 | | | | | | | 295x595x9mm | | |



Panou LED slim Solentis / Solentis slim LED panel



| RO | Cod | Denumire | Tip panou | Montaj | Putere | Flux luminos | Temperatură culoare | Dimensiune | Material | Culoare |
|----|------|----------|------------|----------|--------|---------------|---------------------|------------|----------|---------|
| EN | Code | Name | Panel type | Mounting | Power | Luminous flux | Color Temperature | Size | Material | Color |

NOVELITE - PANOURI LED TIP RAMĂ / FRAME-TYPE LED PANELS

| | | | | | | | | | |
|-----------|---|-------------------------------------|----|-----|--------|-------|--------------|---------|-------------|
| EL0075008 | Panou LED tip ramă / Frame-type LED panel | Slim - tip ramă / Frame type - slim | ST | 40W | 3600lm | 4000K | 591x591x11mm | Al + PC | Alb / White |
|-----------|---|-------------------------------------|----|-----|--------|-------|--------------|---------|-------------|

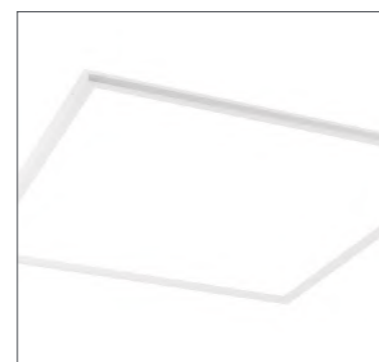

Panou LED tip ramă Novelite / Novelite frame-type LED panel

| RO | Cod | Denumire | Compatibilitate panou | Destinație montaj | Dimensiune | Material | Culoare |
|---|---|--------------|-----------------------|---------------------------|---------------|----------------------|-------------------|
| EN | Code | Name | Panel compatibility | Mounting destination | Size | Material | Color |
| NOVELITE - ACCESORII MONTAJ PANOURI / PANEL MOUNTING ACCESSORIES | | | | | | | |
| EL0057492 | Set 4 cleme panou LED backlit / Set of 4 LED backlit panel clips | Backlit | | Rigips / Plasterboard | - | | - |
| EL0029258 | Set 4 cleme panou LED slim / Set of 4 slim LED panel clips | Slim | | | - | Oțel / Steel | - |
| EL0032601 | Kit montaj suspendat panou LED / LED panel suspension mounting kit | | | Suspendat / Suspended | - | | - |
| EL0057452 | Ramă aplicată panou LED slim/backlit / Surface mounted frame for LED slim/backlit panel | Slim/Backlit | | | 595x595x45mm | PVC | Alb / White |
| EL0075717 | | | | | 595x595x50mm | | |
| EL0032597 | Ramă aplicată panou LED slim / Surface mounted frame for LED slim panel | Slim | | Aplicat / Surface-Mounted | 295x295x50mm | Aluminiu / Aluminium | Argintiu / Silver |
| EL0032598 | | | | | 295x595x50mm | | |
| EL0032599 | | | | | 595x595x50mm | | |
| EL0032600 | | | | | 295x1195x50mm | | |
| EL0037071 | | | | | 295x595x50mm | | |
| EL0037070 | | | | | 595x595x50mm | | |
| EL0037072 | | | | | 295x1195x50mm | | |
| EL0075608 | 595x1195x50mm | | | | | | |
| EL0072063 | Ramă aplicată panou LED backlit / Surface mounted frame for LED backlit panel | Backlit | | | 595x595x65mm | | Alb / White |



EL0057492



EL0029258



EL0032601



EL0057452



EL0075717



EL0032597



EL0032598



EL0032599



EL0032600



EL0037071



EL0037070



EL0037072



DOWNLIGHT

DOWNLIGHT

RO

Corpurile Downlight sunt soluții de iluminat integrate, ideale pentru spații interioare moderne, precum birouri, holuri, săli de ședință sau locuințe. Acestea sunt montate în tavan și oferă o iluminare uniformă și discretă, fără a ocupa spațiu vizibil. Designul lor compact și tehnologia LED eficientă asigură o lumină clară și de înaltă calitate, cu un consum redus de energie și o durată de viață îndelungată.

REPERE

- **Iluminare uniformă** - distribuție eficientă a luminii cu unghi larg de iluminare, ideală pentru spații cu tavan fals;
- **Unghi de dispersie variabil** - opțiuni de 24°, 60°, 110° și 120° pentru a se adapta nevoilor de iluminare specifice ale fiecărui spațiu;
- **Design compact și elegant** - potrivite pentru instalări discrete, cu un aspect modern, ușor de integrat în orice tip de decor.

EN

Downlights are integrated lighting solutions ideal for modern interior spaces, such as offices, hallways, meeting rooms, or residences. These are mounted in the ceiling and provide uniform and discreet lighting, without taking up visible space. Their compact design and efficient LED technology ensure clear and high-quality light, with low energy consumption and a long lifespan.

FEATURES

- **Uniform lighting** - efficient light distribution with a wide beam angle, ideal for false-ceiling spaces;
- **Variable dispersion angle** - options of 24°, 60°, 110°, and 120° to suit specific lighting needs for each space;
- **Compact and elegant design** - suitable for discreet installations, with a modern look, easy to integrate into any type of decor.

RO

| Cod | Denumire | Montaj | Orientare | Putere | Temp. culoare | Flux luminos | Dimensiune | Dimensiune decupaj | Material | Culoare |
|-----|----------|--------|-----------|--------|---------------|--------------|------------|--------------------|----------|---------|
|-----|----------|--------|-----------|--------|---------------|--------------|------------|--------------------|----------|---------|

EN

| Code | Name | Mounting | Orientation | Power | Color temp. | Luminous flux | Size | Cut-out dimensions | Material | Color |
|------|------|----------|-------------|-------|-------------|---------------|------|--------------------|----------|-------|
|------|------|----------|-------------|-------|-------------|---------------|------|--------------------|----------|-------|

NOVELITE - DOWNLIGHT LED / LED DOWNLIGHT

| | | | | | | | | | | |
|-----------|---|----|-------------------------------------|-------|-------|--------|-----------|--------|--------------------------|-------------|
| EL0039174 | | | | 30W | 3000K | 2400lm | ø190x60mm | ø170mm | Al + Sticlă / Al + Glass | Alb / White |
| EL0039175 | Downlight LED fix / Fixed LED downlight | ST | FIX - Reflector / FIXED - reflector | 4000K | | | | | | |
| EL0039176 | | | | 40W | 3000K | 3200lm | ø230x70mm | ø210mm | | |
| EL0039177 | | | | 4000K | | | | | | |



Downlight LED fix Novelite / Novelite fixed LED downlight



NOVELITE - DOWNLIGHT LED / LED DOWNLIGHT

| | | | | | | | | | | |
|-----------|---|----|---|-----|-------|--------|------------|--------|--------------------------|-------------|
| EL0039179 | | | | 24W | | 1920lm | ø138x115mm | ø120mm | Al + Sticlă / Al + Glass | Alb / White |
| EL0039181 | Downlight LED reglabil / Adjustable LED downlight | ST | REGLABIL - Reflector / ADJUSTABLE - Reflector | 30W | 4000K | 2400lm | ø160x115mm | ø140mm | | |
| EL0039183 | | | | 40W | | 3200lm | ø180x115mm | ø160mm | | |



Downlight LED reglabil Novelite / Novelite adjustable LED downlight



| RO | Cod | Denumire | Montaj | Orientare | Putere | Temperatură culoare | Flux luminos | Dimensiune | Dimensiune decupaj | Material | Culoare |
|----|------|----------|----------|-------------|--------|---------------------|---------------|------------|--------------------|----------|---------|
| EN | Code | Name | Mounting | Orientation | Power | Color temperature | Luminous flux | Size | Cut-out dimensions | Material | Color |

SOLENTIS - DOWNLIGHT LED / LED DOWNLIGHT

| | | | | | | | | | | |
|-----------|---|----|------------------------------------|-----|-------|--------|-----------|--------|--------------|-------------|
| EL0073018 | Downlight LED slim fix / Fixed slim LED downlight | ST | Fix - dispersor / Fixed - diffuser | 12W | 4000K | 1200lm | ø170x30mm | ø155mm | Plastic + PC | Alb / White |
| EL0073019 | | | | 24W | | | ø225x30mm | ø205mm | | |



Downlight LED slim fix Solentis / Solentis fixed slim LED downlight



| RO | Cod | Denumire | Montaj | Orientare | Putere | Temperatură culoare | Flux luminos | Dimensiune | Dimensiune decupaj | Material | Culoare |
|----|------|----------|----------|-------------|--------|---------------------|---------------|------------|--------------------|----------|---------|
| EN | Code | Name | Mounting | Orientation | Power | Color Temperature | Luminous flux | Size | Cut-out dimensions | Material | Color |

SOLENTIS - DOWNLIGHT LED / LED DOWNLIGHT

| | | | | | | | | | | |
|-----------|---|----|------------------------------------|-----|-------|--------|-------------|--------|---------|-------------|
| EL0067708 | Downlight LED slim fix / Fixed slim LED downlight | ST | Fix - dispersor / Fixed - diffuser | 10W | 4000K | 1000lm | ø110x35,5mm | ø89mm | Al + PC | Alb / White |
| EL0067709 | | | | 20W | | | ø140x38mm | ø125mm | | |
| EL0067710 | | | | 30W | | | ø165x38mm | ø150mm | | |
| EL0067711 | | | | 40W | | | ø215x41mm | ø200mm | | |



Downlight LED slim fix Solentis / Solentis fixed slim LED downlight

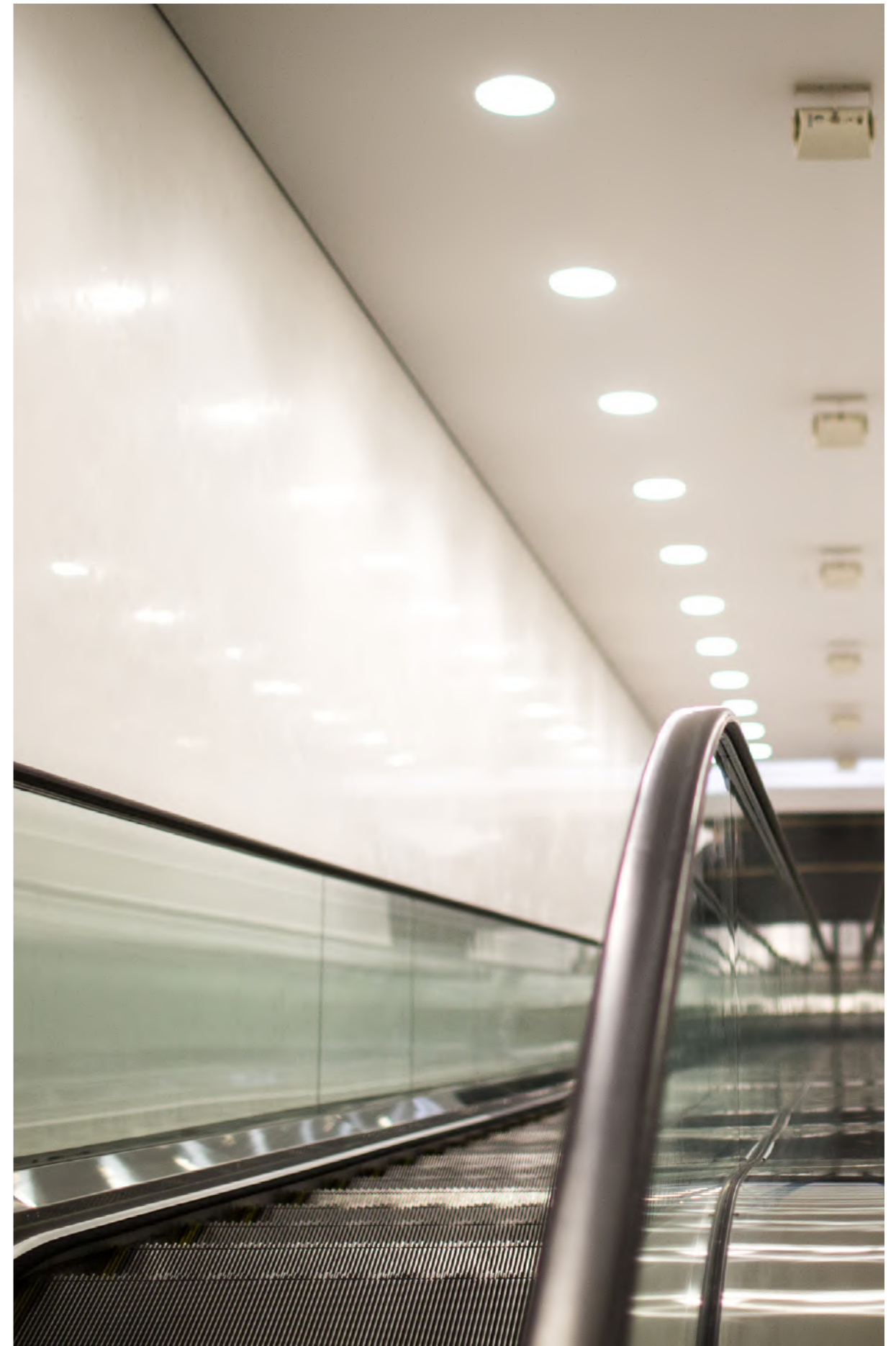



ILUMINAT ȘINĂ TRACK LIGHTING

RO

Iluminatul pe șină este o soluție modernă și versatilă, ideală pentru spații comerciale, rezidențiale și expoziționale. Sistemele de iluminat pe șină permit configurări personalizate, oferind flexibilitate în poziționarea și orientarea corpurilor de iluminat. Tehnologiile avansate, precum șinele magnetice și spoturile LED eficiente, asigură un iluminat direcționat, adaptabil și estetic.

REPERE

- **Modularitate și flexibilitate** - posibilitatea de a ajusta și re poziționa corpurile de iluminat în funcție de necesități;
- **Eficiență energetică** - spoturile LED și sistemele magnetice asigură un consum redus și o iluminare optimă;
- **Design modern** - potrivite pentru spații minimaliste, industriale sau contemporane, oferind un aspect elegant și funcțional.

EN

Track lighting is a modern and versatile solution, ideal for commercial, residential, and exhibition spaces. Track lighting systems allow for customizable configurations, offering flexibility in the positioning and orientation of lighting fixtures. Advanced technologies such as magnetic tracks and energy-efficient LED spotlights ensure directed, adaptable, and aesthetic lighting.

FEATURES

- **Modularity and flexibility** - the ability to adjust and reposition lighting fixtures according to needs;
- **Energy efficiency** - LED spotlights and magnetic systems ensure low consumption and optimal lighting;
- **Modern design** - suitable for minimalist, industrial, or contemporary spaces, offering an elegant and functional look.

RO

| Cod | Denumire | Sursă | Montaj | Temperatură culoare | Putere | Flux luminos | Material | Culoare |
|-----|----------|-------|--------|---------------------|--------|--------------|----------|---------|
|-----|----------|-------|--------|---------------------|--------|--------------|----------|---------|

EN

| Code | Name | Source | Mounting | Color temperature | Power | Luminous flux | Material | Color |
|------|------|--------|----------|-------------------|-------|---------------|----------|-------|
|------|------|--------|----------|-------------------|-------|---------------|----------|-------|

NOVELITE - SPOTURI LED ȘINĂ CLASICĂ / CLASSIC TRACK LED SPOTLIGHT

| | | | | | | | | |
|-----------|---|---------|------------------------|-------|-----|--------|----------------------|---------------|
| EL0037292 | | | | 6400K | | | | Alb / White |
| EL0037293 | | | | 3000K | | | | Negru / Black |
| EL0068321 | Spot LED șină clasică / Classic track LED spotlight | LED COB | Pe șină / On the track | 6400K | 20W | 1400lm | Aluminiu / Aluminium | Alb / White |
| EL0068322 | | | | 3000K | | | | Negru / Black |



EL0037292



EL0037293



EL0068321

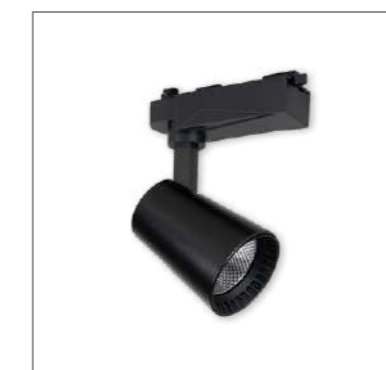

EL0068322

IP20

| RO | Cod | Denumire | Montaj | Putere | Tensiune / frecvență alimentare | Dimensiune | Material | Culoare |
|----|------|----------|----------|--------|---------------------------------------|------------|----------|---------|
| EN | Code | Name | Mounting | Power | Voltage/ Frequency Input | Size | Material | Color |

NOVELITE - ILUMINAT ȘINĂ MAGNETICĂ / MAGNETIC TRACK LIGHTING

| | | | | | | | | |
|-----------|--|---|----|------|-------|--------------|---|------------------|
| EL0073281 | | | PT | - | | 1000x53x26mm | | |
| EL0073282 | Șină magnetică iluminat / Magnetic track lighting | | ST | - | 48VDC | 1000x46x60mm | Aluminiu + Cupru/ Aluminium + Copper | Negru / Black |
| EL0073400 | | | PT | - | | 2000x53x26mm | | |
| EL0073401 | | | ST | - | | 2000x46x60mm | | |
| EL0073302 | | Clips montaja aparent / Surface mounting clips | PT | - | | - | | |
| EL0073283 | Alimentator șină magnetică / Magnetic track power supply | | - | 100W | 230V | - | Plastic | - |
| EL0073284 | | | - | 200W | | - | Plastic | - |
| EL0073307 | Element colț vertical interior 90° / 90° vertical interior corner element | | PT | - | - | - | Aluminiu / Aluminium | Negru / Black |
| EL0073311 | | | ST | - | - | - | | |
| EL0073306 | Element colț vertical exterior 90° / 90° vertical exterior corner element | | PT | - | - | - | Aluminiu / Aluminium | Negru / Black |
| EL0073310 | | | ST | - | - | - | | |
| EL0073304 | Element colț orizontal 90° / 90° horizontal corner element | | PT | - | - | - | Aluminiu / Aluminium | Negru / Black |
| EL0073309 | | | ST | - | - | - | | |
| EL0073286 | Conector alimentare colț / Corner power connector | | - | | 48VDC | - | Plastic | |
| EL0073285 | Conector alimentare liniar / Linear power connector | | - | | | - | Plastic | |
| EL0073301 | Kit suspendare șină magnetică / Magnetic track suspension kit | | - | | - | - | Oțel / Steel | - |
| EL0073303 | Conector metalic șină magnetică / Magnetic track metal connector | | - | | - | - | Aluminiu / Aluminium | Negru / Black |
| EL0073399 | | | - | | - | - | | |



EL0073281



EL0073401



EL0073302



EL0073311



EL0073306



EL0073310



EL0073304



EL0073309



EL0073286



EL0073285



EL0073301



EL0073303

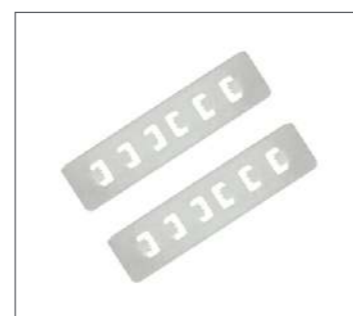

EL0073399

CORPURI DE
ILUMINAT DECORATIVE

SURSE

SMART HOME

APARATAJ

CONECTICĂ

PROTECȚII

CORPURI DE
ILUMINAT TEHNICE

TRASEE

CABLURI

DECORATIVE LIGHTING
FIXTURES

SOURCES

SMART HOME

SWITCHES AND
SOCKETS

CONNECTORS

POWER
AUTOMATION

TECHNICAL LIGHTNING
FIXTURES

CABLE MANAGEMENT
SYSTEMS

CABLES



| RO | Cod | Denumire | Montaj | Putere | Flux luminos | Unghi dispersie | Dimensiune | Material | Culoare |
|----|------|----------|----------|--------|---------------|------------------|------------|----------|---------|
| EN | Code | Name | Mounting | Power | Luminous flux | Dispersion angle | Size | Material | Color |

NOVELITE - ILUMINAT ȘINĂ MAGNETICĂ / MAGNETIC TRACK LIGHTING

| | | | | | | | | | |
|-----------|---|------------------------|-----|--------|--------|------|-------|----------------------|---------------|
| EL0073327 | | | | 10W | 900lm | | 300mm | | |
| EL0073328 | Spot liniar șină magnetică / Magnetic track linear spot | | | 20W | 1800lm | 110° | 600mm | | |
| EL0073329 | | | 30W | 2700lm | 900mm | | | | |
| EL0073330 | | | 40W | 3600lm | 1200mm | | | | |
| EL0073312 | | | 12W | 1080lm | 220mm | | | | |
| EL0073313 | Spot fagure șină magnetică / Magnetic track honeycomb spot | | | 18W | 1620lm | | 328mm | | |
| EL0073316 | | | | 6W | 540lm | | 115mm | | |
| EL0073317 | | | | 12W | 1080lm | | 229mm | | |
| EL0073314 | Spot clasic șină magnetică / Magnetic track classic spot | Pe șină / On the track | | 12W | 1080lm | | - | Aluminiu / Aluminium | Negru / Black |
| EL0073315 | | | 20W | 1800lm | - | | | | |
| EL0073318 | Spot fagure șină magnetică / Magnetic track honeycomb spot | | | 16W | 1440lm | | - | | |
| EL0073324 | Spot suspendat șină magnetică / Suspended spot magnetic track | | | 10W | 900lm | 24° | - | | |
| EL0073323 | | | 7W | 630lm | - | | | | |
| EL0073325 | Spot clasic șină magnetică / Magnetic track classic spot | | 10W | 900lm | - | | | | |
| EL0073326 | Spot glob șină magnetică / Magnetic track globe spot | | 12W | 1080lm | - | | | | |
| EL0073319 | | | 6W | 540lm | - | | | | |
| EL0073320 | Spot fagure șină magnetică / Magnetic track honeycomb spot | | 12W | 1080lm | - | | | | |
| EL0073322 | | | 18W | 1620lm | - | | | | |

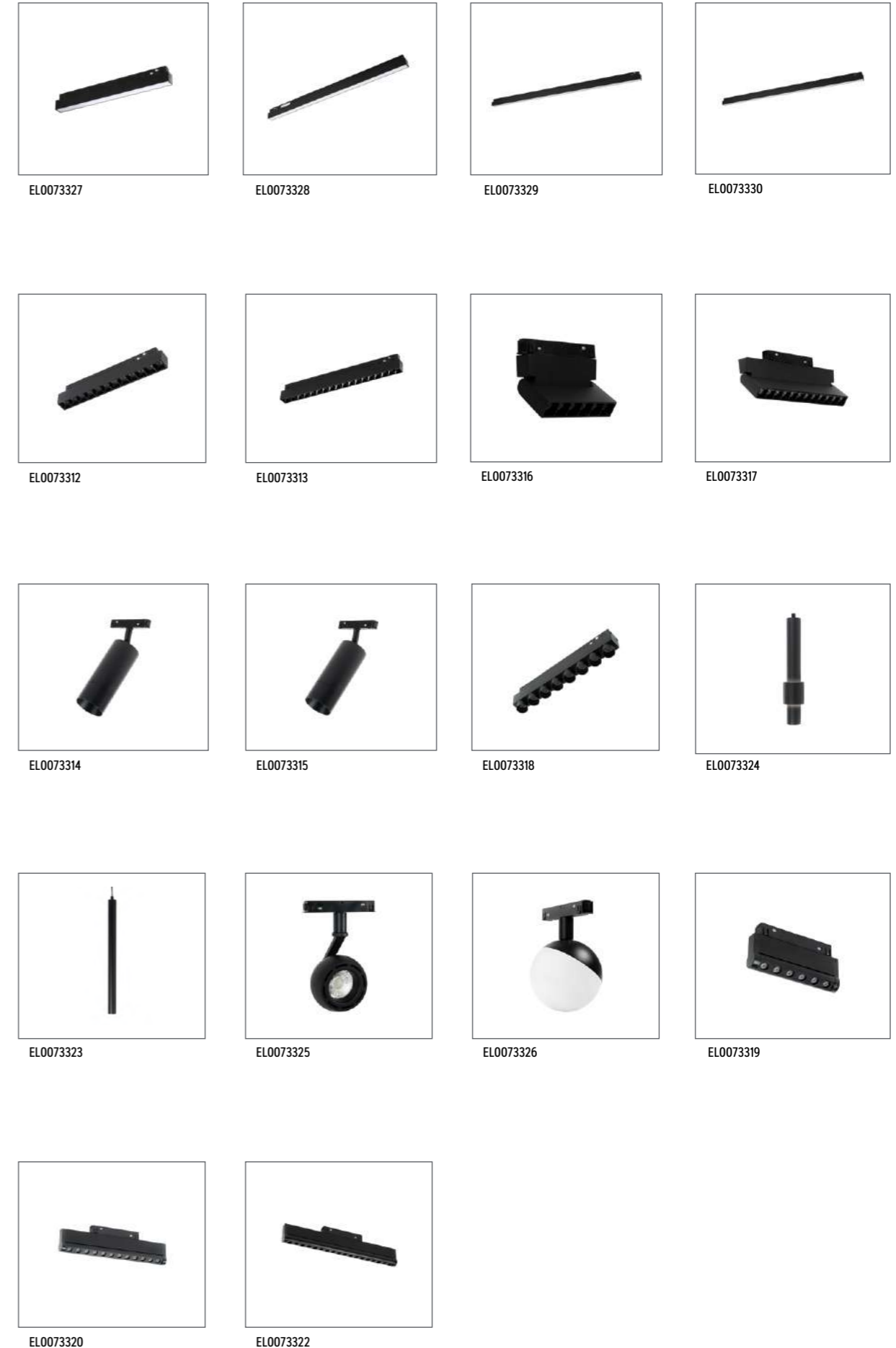

IP20 230V

| RO | Cod | Denumire | Montaj | Dimensiune | Material | Culoare |
|----|------|----------|----------|------------|----------|---------|
| EN | Code | Name | Mounting | Size | Material | Color |

NOVELITE - ILUMINAT ȘINĂ CLASICĂ / CLASSIC TRACK LIGHTING

| | | | | | | |
|-----------|---|----|--------------|---------------|--|--|
| EL0037301 | Șină clasică pentru spot LED / Classic track for LED spotlight | PT | 1000x35x20mm | Alb / White | | |
| EL0037303 | | | 1000x35x20mm | Negru / Black | | |
| EL0037304 | Conector șină clasică / Classic track connector | PT | - | Alb / White | | |
| EL0037305 | | | - | Negru / Black | | |
| EL0037306 | | | - | Alb / White | | |
| EL0037307 | | | - | Negru / Black | | |
| EL0037310 | | | - | Alb / White | | |
| EL0037311 | | | - | Negru / Black | | |
| EL0037308 | | | - | Alb / White | | |
| EL0037309 | | | - | Negru / Black | | |
| | | | | | | |
| | | | | | | |

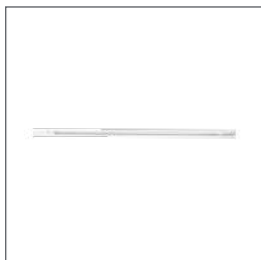

EL0037301



EL0037303



EL0037304



EL0037305



EL0037306



EL0037304



EL0037310

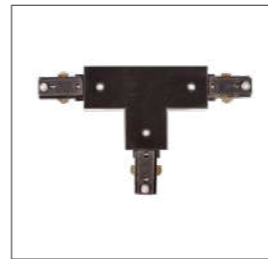

EL0037311

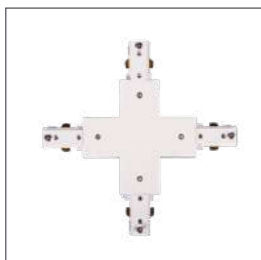

EL0037308

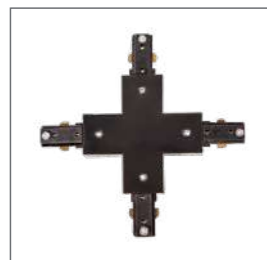

EL0037309





CORP BAT BAT LIGHT

RO

Corpurile BAT sunt soluții versatile și eficiente pentru iluminatul industrial și comercial, fiind disponibile în diverse forme și dimensiuni (rotund, oval, liniar, colț rotund). Acestea sunt ideale pentru iluminarea spațiilor de birouri, hale, depozite și zone de producție. Modelele cu dulie E27 sunt potrivite pentru surse de iluminat convenționale, în timp ce modelele LED asigură economii de energie și o durată lungă de viață. De asemenea, sunt disponibile și variante LED de urgență, esențiale pentru siguranța în caz de avarie.

REPERE

- **Versatilitate în design** - opțiuni variate, inclusiv forme rotunde, ovale, liniare și colțuri rotunjite, pentru a satisface diferite nevoi de iluminat;
- **Tehnologie LED eficientă** - reducerea consumului de energie și o durată de viață extinsă, oferind performanță constantă;
- **Funcționalitate de urgență** - modele cu opțiune LED, asigurând iluminare în caz de pană de curent sau situații de avarie.

EN

BAT fixtures are versatile and efficient solutions for industrial and commercial lighting, available in various shapes and sizes (round, oval, linear, rounded corner). They are ideal for lighting office spaces, halls, warehouses, and production areas. Models with E27 sockets are suitable for conventional light sources, while LED models provide energy savings and a long lifespan. Emergency LED versions are also available, essential for safety during power failures.

FEATURES

- **Design versatility** - various options, including round, oval, linear shapes, and rounded corners, to meet different lighting needs.
- **Efficient LED technology** - reduced energy consumption and extended lifespan, offering consistent performance.
- **Emergency functionality** - LED models ensure lighting during power outages or emergency situations.

RO

| Cod | Denumire | Montaj | Formă | Sursă | Dimensiune | Material | Culoare | Dispersor | Grilaj protecție |
|-----|----------|--------|-------|-------|------------|----------|---------|-----------|------------------|
|-----|----------|--------|-------|-------|------------|----------|---------|-----------|------------------|

EN

| Code | Name | Mounting | Shape | Source | Size | Material | Color | Diffuser | Protective grille |
|------|------|----------|-------|--------|------|----------|-------|----------|-------------------|
|------|------|----------|-------|--------|------|----------|-------|----------|-------------------|

NOVELITE - CORPURI BAT E27 / E27 BAT LIGHTS

| | | | | | | | | | |
|-----------|--|----|----------------|--------------|---------------|---------------------------------------|---------------|------|----------|
| EL0041139 | | | Rotund / Round | | ø175x85mm | | Alb / White | | Da / Yes |
| EL0042843 | Corp BAT cu dulie E27 / BAT E27 holder light | PT | | E27 max. 60W | ø230x105mm | Sticlă + Aluminiu / Glass + Aluminium | | OPAL | |
| EL0041140 | | | | | 210x105x85mm | | Negru / Black | | - |
| EL0041141 | | | Oval | | 275x155x105mm | | Alb / White | | - |



EL0041139



EL0042843



EL0041140



EL0041141



RO

| Cod | Denumire | Montaj | Formă | Putere | Temp. culoare | Flux luminos | Dimensiune | Material | Culoare |
|-----|----------|--------|-------|--------|---------------|--------------|------------|----------|---------|
|-----|----------|--------|-------|--------|---------------|--------------|------------|----------|---------|

EN

| Code | Name | Mounting | Shape | Power | Color temperature | Luminous flux | Size | Material | Color |
|------|------|----------|-------|-------|-------------------|---------------|------|----------|-------|
|------|------|----------|-------|-------|-------------------|---------------|------|----------|-------|

HOMELIGHT - CORPURI BAT LED / LED BAT LIGHTS

| | | | | | | | | | |
|-----------|---|----|----------------|-----|-------|--------|--------------|---------|-------------|
| EL0080983 | Corp BAT LED oval / Oval LED BAT light | | Oval | 12W | | 840lm | 160x85x35mm | PP | |
| EL0081234 | | PT | | 16W | 6500K | 1760lm | 206x102x51mm | PP + PS | Alb / White |
| EL0080982 | Corp BAT LED rotund / Round LED BAT light | | Rotund / Round | 12W | | 840lm | ø140x37mm | PP | |
| EL0081233 | | | | 16W | | 1760lm | ø158x51mm | PP + PS | |



EL0080983



EL0081234



EL0080982



EL0080982



| RO | Cod | Denumire | Montaj | Formă | Putere | Temperatură culoare | Flux luminos | Grad de protecție | Dimensiune | Material | Culoare |
|----|------|----------|----------|-------|--------|---------------------|---------------|---------------------------|------------|----------|---------|
| EN | Code | Name | Mounting | Shape | Power | Color temperature | Luminous flux | Ingress protection rating | Size | Material | Color |

NOVELITE - CORP BAT LED / LED BAT LIGHTS

| RO | Cod | Denumire | Montaj | Formă | Putere | Temperatură culoare | Flux luminos | Grad de protecție | Dimensiune | Material | Culoare |
|----|-----------|---|----------|----------------------------|--------|---------------------|---------------|---------------------------|---------------|----------|---------------|
| EN | Code | Name | Mounting | Shape | Power | Color temperature | Luminous flux | Ingress protection rating | Size | Material | Color |
| | EL0075926 | Corp BAT LED liniar / Liniar LED BAT light | | Liniar | 15W | 6400K | 1350lm | IP54 | 350x75x50mm | | |
| | EL0076125 | | | | 12W | 4000K | 1200lm | | ø200x98x46mm | | Alb / White |
| | EL0075922 | | | | | 6400K | | | ø200x98x46mm | | Alb / White |
| | EL0076126 | Corp BAT LED colț rotund / Round corner LED BAT light | | Colț rotund / Round corner | 18W | 4000K | 1800lm | | ø230x105x46mm | | |
| | EL0075923 | | | | | | | | ø230x105x46mm | | |
| | EL0076129 | | | | 12W | 6400K | 1200lm | | ø200x98x46mm | PP | Negru / Black |
| | EL0076130 | | | | 18W | | 1800lm | | ø230x105x46mm | PP | Negru / Black |
| | EL0076123 | | | | 12W | 4000K | 1200lm | | ø155x52mm | | |
| | EL0075920 | | | | | 6400K | | | ø155x52mm | | Alb / White |
| | EL0076124 | Corp BAT LED rotund / Round LED BAT light | PT | Rotund / Round | 18W | 4000K | 1800lm | IP65 | ø175x52mm | | |
| | EL0075921 | | | | | | | | ø175x52mm | | |
| | EL0076127 | | | | 12W | | 1200lm | | ø155x52mm | | |
| | EL0076128 | | | | 18W | 6400K | 1800lm | | ø175x52mm | | Negru / Black |
| | EL0032474 | | | | | | | | 220x127x105mm | | Alb / White |
| | EL0032476 | Corp BAT LED oval / Oval LED BAT light | | Oval | | 3000K | | | 220x127x105mm | | |
| | EL0032477 | | | | | 6400K | | | 220x127x105mm | | Negru / Black |
| | EL0032479 | | | | 12W | 3000K | 840lm | | 220x127x105mm | PVC | |
| | EL0032484 | | | | | 6400K | | | ø220x105mm | | Alb / White |
| | EL0032485 | Corp BAT LED rotund / Round LED BAT light | | Rotund / Round | | 3000K | | | ø220x105mm | | |
| | EL0032486 | | | | | 6400K | | | ø220x105mm | | Negru / Black |
| | EL0032490 | | | | | 3000K | | | ø220x105mm | | Negru / Black |



| RO | Cod | Denumire | Montaj | Formă | Putere | Temperatură culoare | Flux luminos | Dimensiune | Material | Culoare | Echipare specială |
|----|------|----------|----------|-------|--------|---------------------|---------------|------------|----------|---------|-------------------|
| EN | Code | Name | Mounting | Shape | Power | Color temperature | Luminous flux | Size | Material | Color | Special equipment |

NOVELITE - CORPURI BAT LED CU SENZOR / LED BATLIGHTS WITH SENSOR

| | | | | | | | | | | | |
|-----------|---|----|--|----------------------------|-----|-------|--------|---------------|----|-------------|--|
| EL0076180 | Corp BAT LED urgență / Emergency LED BAT light | | | Rotund / Round | | 6400K | | ø180x80mm | | | Senzor mw + Kit EM 3h / MW Sensor + EM3h Kit |
| EL0076182 | Corp BAT LED colț rotund / Round corner LED BAT light | PT | | Colț rotund / Round corner | 18W | 4000K | 1800lm | ø230x105x46mm | PP | Alb / White | Senzor MW / MW Sensor |
| EL0076181 | | | | Rotund / Round | | 6400K | | ø175x52mm | | | Senzor MW / MW Sensor |





CORPURI ETANȘE PRAF ȘI APĂ DUST AND WATERPROOF LIGHTING FIXTURES

RO

Corpurile etanșe, la praf și apă, sunt soluții ideale pentru iluminarea în medii solicitante, cum ar fi hale industriale, depozite, băi, spații exterioare protejate sau alte zone unde umiditatea, praful și condițiile de mediu extreme sunt factori critici. Cu un grad de protecție IP65/IP66, aceste corpuri sunt rezistente la praf, apă și substanțe chimice, asigurând o iluminare de înaltă performanță și fiabilitate în orice condiții de operare.

REPERE

- **Protecție ridicată** - grad de protecție IP65/IP66, ideal pentru medii cu umiditate ridicată sau expunere la praf;
- **Durabilitate** - construcție robustă, rezistență la substanțe chimice și șocuri mecanice;
- **Materiale diverse** - realizate din PC, ABS+PVC, ABS+PC pentru o rezistență sporită și o durabilitate crescută în condiții extreme.

EN

Dust and waterproof lighting fixtures are ideal solutions for lighting in demanding environments, such as industrial halls, warehouses, bathrooms, protected outdoor spaces, or other areas where humidity, dust, and extreme environmental conditions are critical factors. With an IP65/IP66 protection rating, these fixtures are resistant to dust, water, and chemicals, ensuring high-performance and reliability under any operating conditions.

FEATURES

- **High Protection** - IP65/IP66 protection rating, ideal for environments with high humidity or exposure to dust;
- **Durability** - robust construction, resistant to chemicals and mechanical shocks;
- **Various materials** - made from PC, ABS+PVC, ABS+PC for enhanced resistance and increased durability in extreme conditions.

LED IP65 230V

| RO | Cod | Denumire | Putere | Temperatură culoare | Flux luminos | Lungime generică | Dimensiune | Material |
|----|------|----------|--------|---------------------|---------------|------------------|------------|----------|
| EN | Code | Name | Power | Color temperature | Luminous flux | Generic length | Size | Material |

HOMELIGHT - CORPURI LINIARE ETANȘE IP65 LED / IP65 LED WATERPROOF FIXTURES

| | | | | | | | |
|-----------|---------------------------------------|-----|-------|--------|--------|--------------|----|
| EL0060106 | Corp etanș LED IP65 extrudat v1 / | 18W | 6400K | 1440lm | 600mm | 570x60x35mm | PC |
| EL0060107 | Extruded IP65 LED waterproof light v1 | 36W | | 648lm | 1200mm | 1170x63x35mm | |
| EL0083305 | Corp etanș LED IP65 extrudat v2 / | 18W | | 1620lm | 600mm | 570x52x35mm | |
| EL0083306 | Extruded IP65 LED waterproof light v2 | 36W | | 3240lm | 1200mm | 1170x52x35mm | |



Corp etanș v1 LED IP65 extrudat / Extruded IP65 LED waterproof light v1

LED IP65 230V

| RO | Cod | Denumire | Putere | Temperatură culoare | Flux luminos | Lungime generică | Dimensiune | Material | Interconectabil |
|----|------|----------|--------|---------------------|---------------|------------------|------------|----------|------------------|
| EN | Code | Name | Power | Color temperature | Luminous flux | Generic length | Size | Material | Interconnectable |

NOVELITE - CORPURI LINIARE ETANȘE IP65 LED / IP65 LED WATERPROOF FIXTURES

| | | | | | | | | |
|-----------|---|-----|-------|--------|--------|--------------|-----------|------------------------------|
| EL0057440 | Corp etanș LED IP65 extrudat interconectabil / | 18W | 6500K | 1620lm | 600mm | 555x63x35mm | ABS + PVC | Da max. 300W / Yes 300W max. |
| EL0057441 | Interconnectable IP65 extruded linear LED light | 36W | | 3240lm | 1200mm | 1155x63x35mm | | |
| EL0057442 | | 45W | | 4050lm | 1500mm | 1455x63x35mm | | |



Corp etanș LED IP65 extrudat interconectabil / Interconnectable IP65 extruded linear LED light



| RO | Cod | Denumire | Putere | Temperatură culoare | Flux luminos | Lungime generică | Dimensiune | Material |
|----|------|----------|--------|---------------------|---------------|------------------|------------|----------|
| EN | Code | Name | Power | Color temperature | Luminous flux | Generic length | Size | Material |

NOVELITE CORPURI LINIARE ETANȘE IP65 LED / IP65 LED WATERPROOF FIXTURES

| | | | | | | | |
|-----------|---|-----|-------|--------|--------|--------------|-----------|
| EL0031546 | Corp etanș LED IP65 slim / Slim IP65 LED waterproof light | 20W | 5000K | 1600lm | 600mm | 600x76x66mm | ABS + PVC |
| EL0031548 | | 40W | | 3200lm | 1200mm | 1200x76x66mm | |
| EL0037058 | | 50W | | 4000lm | 1500mm | 1500x76x66mm | |



Corp etanș LED IP65 slim / Slim IP65 LED waterproof light



| RO | Cod | Denumire | Putere | Temperatură culoare | Flux luminos | Lungime generică | Dimensiune | Material | Interconectabil |
|----|------|----------|--------|---------------------|---------------|------------------|------------|----------|------------------|
| EN | Code | Name | Power | Color temperature | Luminous flux | Generic length | Size | Material | Interconnectable |

SOLENTIS CORPURI LINIARE ETANȘE IP65 LED / IP65 LED WATERPROOF FIXTURES

| | | | | | | | | |
|-----------|--|-----|-------|--------|--------|---------------|----|--------------------------------|
| EL0071842 | Corp etanș LED IP65 clasic / Classical IP65 LED waterproof light | 20W | 4000K | 2600lm | 600mm | 660x130x86mm | PC | Da, max. 300W / Yes, 300W max. |
| EL0071841 | | 29W | | 3770lm | 1200mm | 1270x130x86mm | | |
| EL0071839 | | 30W | | 3900lm | 1500mm | 1570x130x86mm | | |
| EL0071840 | | 48W | | 6240lm | 1200mm | 1270x130x86mm | | |
| EL0071838 | | 60W | | 7800lm | 1500mm | 1570x130x86mm | | |



Corp etanș LED IP65 clasic / Classical IP65 LED waterproof light



| RO | Cod | Denumire | Putere | Temperatură culoare | Flux luminos | Lungime generică | Dimensiune | Material |
|----|------|----------|--------|---------------------|---------------|------------------|------------|----------|
| EN | Code | Name | Power | Color temperature | Luminous flux | Generic length | Size | Material |

NOVELITE CORPURI LINIARE ETANȘE IP65 LED / IP65 LED WATERPROOF FIXTURES

| | | | | | | | |
|-----------|--|-----|-------|--------|--------|---------------|-----------|
| EL0067832 | Corp etanș LED IP65 clasic / Classical IP65 LED waterproof light | 20W | 6400K | 2000lm | 600mm | 656x120x77mm | ABS + PVC |
| EL0067833 | | 40W | | 4000lm | 1200mm | 1266x120x77mm | |
| EL0067834 | | 60W | | 6000lm | 1500mm | 1566x120x77mm | |



Corp etanș LED IP65 clasic / Classical IP65 LED waterproof light



| RO | Cod | Denumire | Sursă | Tip tub | Lungime | Dimensiune | Material |
|----|------|----------|--------|-----------|---------|------------|----------|
| EN | Code | Name | Source | Tube type | Length | Size | Material |

NOVELITE - CORPURI LINIARE ETANȘE IP65 LED / IP65 LED WATERPROOF FIXTURES

| | | | | | | |
|-----------|--|--|---------------------------------------|----------|--------------|-----------|
| EL0075886 | Corp etanș IP65 neechipat cu tub LED T8 / IP65 LED light non equipped with T8 LED tube | Tub LED - neinclus / Tube LED non included | Alimentare la 2 capete / 2-End supply | 1x600mm | 662x65x62mm | ABS + PVC |
| EL0075890 | | | | 1x1200mm | 1272x65x62mm | |
| EL0075900 | | | | 1x1500mm | 1572x65x62mm | |
| EL0075888 | | | | 2x600mm | 662x95x62mm | |
| EL0075893 | | | | 2x1200mm | 1272x95x62mm | |
| EL0075901 | | | | 2x1500mm | 1572x95x62mm | |



Corp etanș IP65 neechipat cu tub LED T8 / IP65 LED light Non equipped with T8 LED tube



| RO | Cod | Denumire | Putere | Temp. culoare | Flux luminos | Grad de protecție | Echipe specială | Dimensiune | Material | Culoare |
|----|------|----------|--------|-------------------|---------------|---------------------------|-------------------|------------|----------|---------|
| EN | Code | Name | Power | Color temperature | Luminous flux | Ingress protection rating | Special equipment | Size | Material | Color |

SOLENTIS - PLAFONIERE ETANȘE / WATERPROOF CEILING LIGHT

| | | | | | | | | | | |
|-----------|---|--|-----|-------|--------|------|---|-------------|----------|-------------|
| EL0068051 | | | 20W | | 1800lm | IP66 | Compatibil cu Kit EM / Compatible with EM Kit | ø300x93.5mm | PC | |
| EL0084010 | Plafonieră LED IP65/IP66 / IP65/IP66 LED ceiling light | | 18W | 4000K | 1980lm | IP65 | Echizat cu senzor MW și KIT EM 3H M/NM / Equipped with MW sensor and EM KIT 3h M/NM | ø320x78mm | ABS + PC | Alb / White |
| EL0084009 | | Echizat cu senzor MW / Equipped with MW sensor | | | | | ø320x78mm | | | |

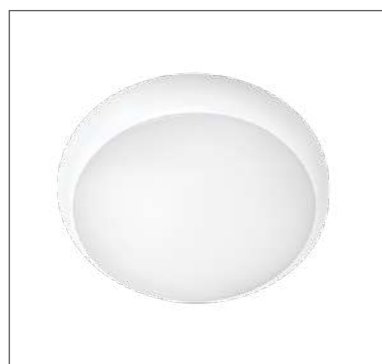

Plafonieră LED IP65/IP66 /
IP65/IP66 LED ceiling light



CORPURI DE ILUMINAT DECORATIVE

SURSE

SMART HOME

APARATAJ

CONECTICĂ

PROTECȚII

CORPURI DE ILUMINAT TEHNICE

TRASEE

CABLURI

DECORATIVE LIGHTING FIXTURES

SOURCES

SMART HOME

SWITCHES AND SOCKETS

CONNECTORS

POWER AUTOMATION

TECHNICAL LIGHTNING FIXTURES

CABLE MANAGEMENT SYSTEMS

CABLES



HIGH BAY

HIGH BAY

RO

Corpurile High Bay sunt special concepute pentru iluminarea eficientă a spațiilor cu tavane înalte (peste 6 metri), cum ar fi hale industriale, depozite logistice, centre comerciale și săli de producție. Acestea utilizează surse LED de înaltă performanță, asigurând un flux luminos puternic, o distribuție uniformă a luminii și un consum redus de energie. Designul termic optimizat și protecția ridicată împotriva factorilor externi le conferă o durată lungă de viață și fiabilitate în medii solicitante.

REPERE

- **Randament luminos superior** - LED-uri cu eficiență de până la 140lm/W, pentru o iluminare uniformă și puternică.
- **Rezistență la impact** - grad de protecție mecanică IK08, oferind durabilitate crescută împotriva șocurilor și loviturilor accidentale.
- **Rezistență industrială** - grad de protecție IP65/IP66, carcasă din aluminiu pentru disipare termică optimă și durabilitate sporită.

EN

High Bay fixtures are specially designed for efficient lighting of spaces with high ceilings (over 6 meters), such as industrial halls, logistics warehouses, shopping centers, and production halls. These use high-performance LED sources, ensuring strong light flow, uniform light distribution, and low energy consumption. The optimized thermal design and high protection against external factors give them a long lifespan and reliability in demanding environments.

FEATURES

- **Superior light output** - LEDs with efficiency up to 140lm/W for uniform and powerful lighting.
- **Impact resistance** - IK08 mechanical protection rating, offering increased durability against shocks and accidental hits.
- **Industrial resistance** - IP65/IP66 protection rating, Aluminium housing for optimal heat dissipation and increased durability.



| RO | Cod | Denumire | Putere | Temperatură culoare | Flux luminos | Dimensiune | Material | Culoare |
|----|------|----------|--------|---------------------|---------------|------------|----------|---------|
| EN | Code | Name | Power | Color temperature | Luminous flux | Size | Material | Color |

HOMELIGHT - HIGH BAY LED / LED HIGH BAY

| | | | | | | |
|-----------|-----------------------------|------|-------|---------|---------|---------------|
| EL0080873 | High bay LED / LED High bay | 100W | 6500K | 10000lm | Al + PC | Negru / Black |
| EL0080874 | | 150W | | 15000lm | | |



High bay LED



NOVELITE - HIGH BAY LED / LED HIGH BAY

| | | | | | | | |
|-----------|-----------------------------|------|-------|---------|---------|------------|-----------|
| EL0072805 | High bay LED / LED High bay | 100W | 6500K | 14000lm | Al + PC | Gri / Gray | |
| EL0072806 | | 150W | | 21000lm | | | ø340X30mm |
| EL0072807 | | 200W | | 28000lm | | | ø400X30mm |



High bay LED



| RO | Cod | Denumire | Putere | Temperatură culoare | Flux luminos | Dimensiune | Material | Culoare |
|----|------|----------|--------|---------------------|---------------|------------|----------|---------|
| EN | Code | Name | Power | Color temperature | Luminous flux | Size | Material | Color |

SOLENTIS - HIGH BAY LED / LED HIGH BAY

| | | | | | | | |
|-----------|-----------------------------|------|-------|---------|------------|---------|---------------|
| EL0072348 | High bay LED / LED High bay | 100W | 4000K | 14000lm | ø265x100mm | Al + PC | Negru / Black |
| EL0072349 | | 150W | | 21000lm | ø310x100mm | | |
| EL0072350 | | 200W | | 28000lm | ø345x100mm | | |
| EL0072351 | | 250W | | 35000lm | ø400x120mm | | |
| EL0072352 | | 300W | | 42000lm | | | |



Solentis High bay LED



| RO | Cod | Denumire | Autonomie | Acumulator | Dimensiune | Compatibilitate |
|----|------|----------|-----------|------------|------------|-----------------|
| EN | Code | Name | Autonomy | Battery | Size | Compatibility |

SOLENTIS - HIGH BAY LED / LED HIGH BAY

| | | | | | |
|-----------|---|----|---------|-------------|--------------------------------------|
| EL0072353 | Kit emergență High bay LED / LED High bay emergency kit | 3H | 6000mAh | 250x84x77mm | Solentis seria 5 / Solentis series 5 |
|-----------|---|----|---------|-------------|--------------------------------------|



Kit emergență High bay LED Solentis / LED Solentis High bay emergency kit



CORPURI DE ILUMINAT DECORATIVE
SURSE
SMART HOME
APARATAJ
CONECTICĂ
PROTECȚII
CORPURI DE ILUMINAT TEHNICE
TRASEE
CABLURI

DECORATIVE LIGHTING FIXTURES
SOURCES
SMART HOME
SWITCHES AND SOCKETS
CONNECTORS
POWER AUTOMATION
TECHNICAL LIGHTNING FIXTURES
CABLE MANAGEMENT SYSTEMS
CABLES

LED 230V IP65



PROIECTOARE LED

LED FLOODLIGHTS

RO

Proiectoarele sunt echipamente esențiale pentru iluminarea pe scară largă a spațiilor exterioare, fiind utilizate în scopuri de siguranță și estetică. Acestea oferă un flux luminos puternic, capabil să lumineze eficient suprafețe mari, cum ar fi clădiri, terenuri sportive, parcuri și alei largi.

REPERE

- **Iluminare puternică** - sunt concepute pentru a oferi un flux luminos intens, capabil să ilumineze suprafețe extinse;
- **Durabilitate** - realizate din materiale de înaltă calitate, rezistente la condițiile meteorologice severe și coroziune;
- **Tehnologie LED** - utilizarea tehnologiei LED garantează economii semnificative de energie și o durată de viață extinsă, fiind o alegere ecologică și economică.

EN

Floodlights are essential equipments for large-scale illumination of outdoor spaces, used for both safety and aesthetic purposes. They provide a powerful light flow capable of efficiently illuminating large areas such as buildings, sports fields, parking lots, and wide walkways.

FEATURES

- **Powerful lighting** - are designed to offer intense light flow, capable of illuminating large areas;
- **Durability** - made from high-quality materials resistant to severe weather conditions and corrosion;
- **LED technology** - the use of LED technology guarantees significant energy savings and an extended lifespan, making it an eco-friendly and cost-effective choice.

RO

| Cod | Denumire | Sursă | Putere | Temperatură culoare | Flux luminos | Unghi dispersie | Dimensiune | Material | Culoare |
|-----|----------|-------|--------|---------------------|--------------|-----------------|------------|----------|---------|
|-----|----------|-------|--------|---------------------|--------------|-----------------|------------|----------|---------|

EN

| Code | Name | Source | Power | Color temperature | Luminous flux | Beam angle | Size | Material | Color |
|------|------|--------|-------|-------------------|---------------|------------|------|----------|-------|
|------|------|--------|-------|-------------------|---------------|------------|------|----------|-------|

HOMELIGHT - PROIECTOARE LED / LED FLOODLIGHT

| | | | | | | | | | |
|-----------|--------------------------------|---------|------|-------|--------|------|---------------|---------------------------------------|---------------|
| EL0073797 | | | 10W | | 700lm | | 81x75x20mm | | |
| EL0071133 | | | 20W | | 1400lm | | 101x99x23.5mm | | |
| EL0081226 | Proiector LED / LED floodlight | LED SMD | 30W | 6400K | 2100lm | 100° | 102x92x20mm | Aluminiu + Sticlă / Aluminium + Glass | Negru / Black |
| EL0081227 | | | 50W | | 3500lm | | 128x125x23mm | | |
| EL0081228 | | | 100W | | 7000lm | | 240x230x30mm | | |



Proiector LED Homelight / Homelight LED Floodlight

LED 230V IP65

NOVELITE - PROIECTOARE LED / LED FLOODLIGHT

| | | | | | | | | | |
|-----------|--------------------------------------|---------|------|-------|---------|------|--------------|---|---------------|
| EL0083839 | | | 10W | | 950lm | | 96x90x25mm | | |
| EL0085464 | | | 20W | | 1900lm | | 120x111x28mm | | |
| EL0085465 | | | 30W | | 2850lm | | 143x122x25mm | | |
| EL0085466 | Proiector LED v2 / LED floodlight v2 | | 50W | | 4750lm | | 177x155x25mm | Aluminiu + Sticlă / Aluminium + Glass | |
| EL0085467 | | | 75W | | 7125lm | | 160x165x29mm | | |
| EL0085468 | | LED SMD | 100W | 6500K | 9500lm | 110° | 253x225x29mm | | Negru / Black |
| EL0085469 | | | 150W | | 14250lm | | 273x230x32mm | | |
| EL0085470 | | | 200W | | 19000lm | | 376x310x30mm | | |
| EL0071128 | Proiector LED v4 / LED floodlight v4 | | 250W | | 23750lm | | 350x318x43mm | Aluminiu + Sticlă securizată / Aluminium + Tempered glass | |
| EL0071118 | | | 300W | | 28500lm | | 465x380x35mm | | |
| EL0068803 | | | 400W | | 38000lm | | 555x455x50mm | | |



Proiector LED Novelite / Novelite LED floodlight



| RO | Cod | Denumire | Sursă | Putere | Temperatură culoare | Flux luminos | Unghi dispersie | Dimensiune | Material | Culoare |
|----|------|----------|--------|--------|---------------------|---------------|-----------------|------------|----------|---------|
| EN | Code | Name | Source | Power | Color temperature | Luminous flux | Beam angle | Size | Material | Color |

SOLENTIS - PROIECTOARE LED / LED FLOODLIGHT

| | | | | | | | | | |
|-----------|--------------------------------|---------|------|-------|---------|-----|----------------|---|------------|
| EL0071794 | Proiector LED / LED floodlight | LED SMD | 10W | 4000K | 1100lm | 90° | 110x97x22mm | Aluminiu + Sticlă securizată / Aluminium + Tempered glass | Gri / Gray |
| EL0071795 | | | 20W | | 2200lm | | 121x131x22.8mm | | |
| EL0071797 | | | 30W | | 3300lm | | 154x169x31.3mm | | |
| EL0071799 | | | 50W | | 5500lm | | 182x205x31.7mm | | |
| EL0071800 | | | 100W | | 11000lm | | 216x245x33mm | | |
| EL0071801 | | | 150W | | 16500lm | | 250x277x33mm | | |
| EL0071802 | | | 200W | | 22000lm | | 284x318x33mm | | |



Proiector LED Solentis / Solentis LED floodlight



| RO | Cod | Denumire | Sursă | Putere | Temperatură culoare | Flux luminos | Unghi dispersie | Dimensiune | Material | Culoare |
|----|------|----------|--------|--------|---------------------|---------------|-----------------|------------|----------|---------|
| EN | Code | Name | Source | Power | Color temperature | Luminous flux | Beam angle | Size | Material | Color |

HOMELIGHT - PROIECTOARE LED CU SENZOR / LED FLOODLIGHT WITH SENSOR

| | | | | | | | | | |
|-----------|--|---------|-----|-------|--------|------|--------------|---------------------------------------|---------------|
| EL0060103 | Proiector LED cu senzor / LED floodlight with sensor | LED SMD | 10W | 6400K | 700lm | 100° | 110x87x25mm | Aluminiu + Sticlă / Aluminium + Glass | Negru / Black |
| EL0060104 | | | 20W | | 1400lm | | 110x87x25mm | | |
| EL0081229 | | | 30W | | 2100lm | | 102x85x20mm | | |
| EL0081230 | | | 50W | | 3500lm | | 128x113x23mm | | |

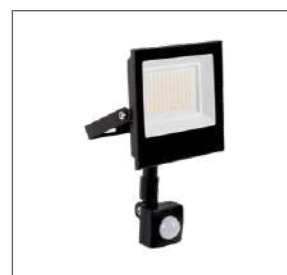

Proiector LED cu senzor Homelight / Homelight LED floodlight with sensor



| RO | Cod | Denumire | Sursă | Putere | Temperatură culoare | Flux luminos | Unghi dispersie | Dimensiune | Material | Culoare |
|----|------|----------|--------|--------|---------------------|---------------|-----------------|------------|----------|---------|
| EN | Code | Name | Source | Power | Color temperature | Luminous flux | Beam angle | Size | Material | Color |

NOVELITE - PROIECTOARE LED CU SENZOR v4 / LED FLOODLIGHT WITH SENSOR v4

| | | | | | | | | | |
|-----------|--|---------|-----|-------|--------|------|--------------|---------------------------------------|---------------|
| EL0085471 | Proiector LED cu senzor / LED floodlight with sensor | LED SMD | 10W | 6500K | 950lm | 110° | 96X151X54mm | Aluminiu + Sticlă / Aluminium + Glass | Negru / Black |
| EL0085472 | | | 20W | | 1900lm | | 117X171X54mm | | |
| EL0085473 | | | 30W | | 2850lm | | 143X187X54mm | | |
| EL0085474 | | | 50W | | 4750lm | | 177X220X54mm | | |



Proiector LED cu senzor Novelite / Novelite LED floodlight with sensor



| RO | Cod | Denumire | Sursă | Putere | Temperatură culoare | Flux luminos | Unghi dispersie | Dimensiune | Material | Culoare |
|----|------|----------|--------|--------|---------------------|---------------|-----------------|------------|----------|---------|
| EN | Code | Name | Source | Power | Color temperature | Luminous flux | Beam angle | Size | Material | Color |

SOLENTIS - PROIECTOARE LED CU SENZOR / LED FLOODLIGHT WITH SENSOR

| | | | | | | | | | |
|-----------|--|---------|-----|-------|--------|-----|--------------|---|------------|
| EL0071803 | Proiector LED cu senzor / LED floodlight with sensor | LED SMD | 10W | 4000K | 1100lm | 90° | 169x97x54mm | Aluminiu + Sticlă securizată / Aluminium + Tempered glass | Gri / Gray |
| EL0071804 | | | 20W | | 2200lm | | 190x121x54mm | | |
| EL0071805 | | | 30W | | 3300lm | | 227x154x55mm | | |
| EL0071806 | | | 50W | | 5500lm | | 263x182x57mm | | |



Proiector LED cu senzor Solentis / Solentis LED floodlight with sensor



| RO | Cod | Denumire | Sursă | Putere | Temperatură culoare | Flux luminos | Unghi dispersie | Dimensiune | Material | Culoare |
|----|------|----------|--------|--------|---------------------|---------------|-----------------|------------|----------|---------|
| EN | Code | Name | Source | Power | Color temperature | Luminous flux | Beam angle | Size | Material | Color |

SOLENTIS - PROIECTOARE LED NOCTURNĂ / NIGHT SPORTS FIELD LED FLOODLIGHT

| | | | | | | | | | |
|-----------|--|---------|-------|-------|-----------|-----|--------------|---|------------|
| EL0074996 | Proiector LED nocturnă / Sportfield LED floodlight | LED SMD | 500W | 4000K | 68.500lm | 90° | 586x440x89mm | Aluminiu + Sticlă securizată / Aluminium + Tempered glass | Gri / Gray |
| EL0074997 | | | 1000W | | 137.000lm | | 714x533x98mm | | |



Proiector LED nocturnă Solentis / Solentis sportfield LED floodlight



| RO | Cod | Denumire | Putere | Temperatură culoare | Flux luminos | Unghi dispersie | Capacitate acumulator | Dimensiune | Material | Culoare |
|----|------|----------|--------|---------------------|---------------|-----------------|-----------------------|------------|----------|---------|
| EN | Code | Name | Power | Color temperature | Luminous flux | Beam angle | Battery capacity | Size | Material | Color |

NOVELITE - PROIECTOARE LED PORTABILE / PORTABLE LED FLOODLIGHT

| | | | | | | | | | |
|-----------|---|------|-------|-------|------|-----|--------------|--------------------------------|------------|
| EL0075722 | Proiector LED portabil cu acumulator / Portable rechargeable LED floodlight | 50W | 6400K | 500lm | 120° | 3Ah | 245x325x55mm | Aluminiu + PC / Aluminium + PC | Gri / Gray |
| EL0075719 | | 100W | | | | 4Ah | 270x355x55mm | | |
| EL0075723 | | 150W | | | | 6Ah | 285x385x55mm | | |
| EL0075740 | | 200W | | | | 9Ah | 320x415x55mm | | |



Proiector LED portabile Novelite / Novelite portable LED floodlight

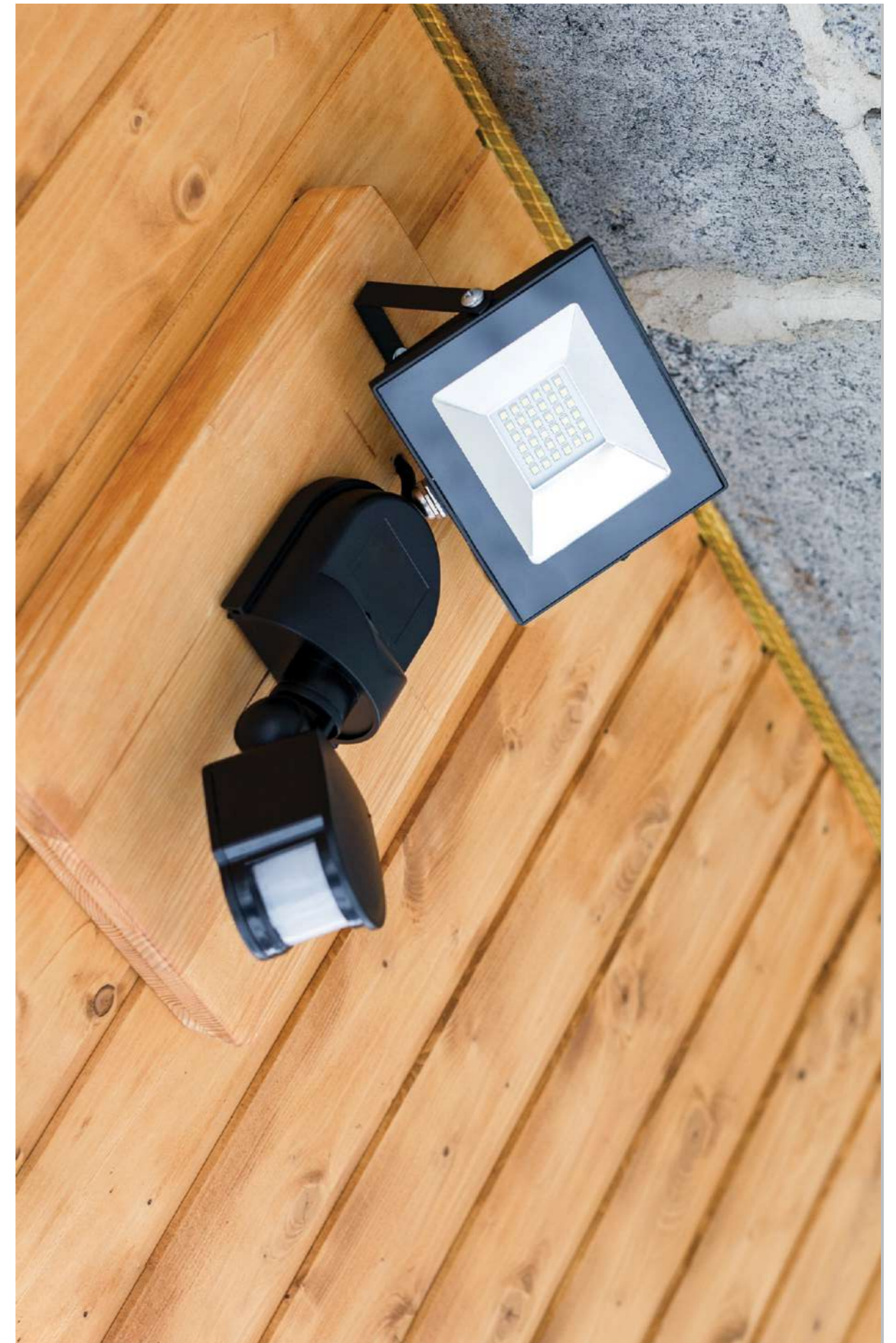



CORPURI STRADALE ȘI PIETONALE STREET AND PEDESTRIAN LIGHTS

RO

Corpurile de iluminat stradale și pietonale sunt concepute pentru a oferi siguranță și vizibilitate optimă în spațiile exterioare, cum ar fi drumurile, parcurile, trotuarele și zonele pietonale. Aceste soluții durabile, rezistente la intemperii, asigură iluminare eficientă pe timp de noapte, contribuind la prevenirea accidentelor și îmbunătățirea vizibilității. Tehnologia LED garantează un consum redus de energie și o durată de viață extinsă.

REPERE

- **Iluminare uniformă** - proiectate pentru o distribuție uniformă a luminii pe suprafețe largi, oferind vizibilitate optimă în spațiile exterioare;
- **Durabilitate ridicată** - carcasă rezistentă la intemperii, cu protecție IP65/IP66, potrivită pentru condiții meteorologice extreme;
- **Tehnologie LED** - eficiență energetică superioară, cu un consum redus și o durată de viață extinsă.

EN

Street and pedestrian lighting fixtures are designed to provide safety and optimal visibility in outdoor spaces such as roads, parks, sidewalks, and pedestrian zones. These durable, weather-resistant solutions ensure efficient lighting at night, helping to prevent accidents and improve visibility. LED technology guarantees low energy consumption and an extended lifespan.

FEATURES

- **Uniform lighting** - designed for uniform light distribution over large areas, providing optimal visibility in outdoor spaces;
- **High durability** - weather-resistant housing with IP65/IP66 protection, suitable for extreme weather conditions;
- **LED technology** - superior energy efficiency, with low consumption and an extended lifespan.



| RO | Cod | Denumire | Putere | Temperatură culoare | Flux luminos | Diametru interior braț | Dimensiune | Material | Culoare |
|----|------|----------|--------|---------------------|---------------|------------------------|------------|----------|---------|
| EN | Code | Name | Power | Color temperature | Luminous flux | Arm inner diameter | Size | Material | Color |

NOVELITE - CORPURI PIETONALE LED / LED PEDESTRIAN LIGHT

| | | | | | | | | |
|-----------|--|------|-------|---------|-------|--------|--------------------------------|------------|
| EL0075331 | Corp pietonal LED / LED pedestrian light | 100W | 6400K | 11000lm | ø80mm | ø458mm | Aluminiu + PC / Aluminium + PC | Gri / Gray |
|-----------|--|------|-------|---------|-------|--------|--------------------------------|------------|



Corp pietonal LED Novelite / Novelite LED Pedestrian Light



NOVELITE - CORPURI PIETONALE LED / LED PEDESTRIAN LIGHT

| | | | | | | | | | | |
|-----------|--|-----|-------|--------|-------|------------|---------------------------------------|------------|--------------------------------|---------------|
| EL0075313 | Corp pietonal LED PARK / LED Park pedestrian light | 30W | 4000K | 4800lm | ø74mm | ø500x450mm | Aluminiu + Sticlă / Aluminium + Glass | Gri / Gray | | |
| EL0075314 | | 60W | | 9600lm | | | | | | |
| EL0075317 | | 30W | | 3600lm | ø64mm | ø560x355mm | | | Aluminiu + PC / Aluminium + PC | Negru / Black |
| EL0075318 | | 60W | | 7200lm | | | | | | |



EL0075313



EL0075317



| RO | Cod | Denumire | Putere | Temp. culoare | Flux luminos | Unghi dispersie | Echipe specială | Diametru interior braț | Tip braț | Unghi reglare braț | Necesita Adaptor | Dimensiune | Material | Culoare |
|----|------|----------|--------|---------------|---------------|-----------------|-------------------|------------------------|----------|----------------------|------------------|------------|----------|---------|
| EN | Code | Name | Power | Color temp. | Luminous flux | Beam angle | Special equipment | Arm inner diameter | Arm type | Arm adjustment angle | Requires adapter | Size | Material | Color |

NOVELITE - CORPURI STRADALE LED / LED STREET LIGHT

| | | | | | | | | | | | | | | |
|-----------|------------------------------|--|------|-------|----------|---------|--------------------------------------|-------|-----------------------|-----------------|--|----------------|--------------------------------|---------------|
| EL0080862 | | | 30W | | 3600lm | | - | | | | | 424x67 x12.6mm | | |
| EL0080863 | Corp stradal ultra slim LED/ | | 50W | | 6000lm | | - | | | | | 507x68 x13.2mm | Aluminiu + PC / Aluminium + PC | Negru / Black |
| EL0080865 | Slim LED street light | | 30W | 6500K | 3600lm | 75x130° | Senzor crepuscular / Twilight sensor | ø64mm | Reglabil / Adjustable | -10° - 0 - +20° | | 424x67 x12.6mm | | |
| EL0084963 | | | 100W | | 12.000lm | | - | | | | | 597x76.3 x15mm | | |



Corp stradal ultra slim LED / Slim LED Street light



NOVELITE - CORPURI STRADALE LED / LED STREET LIGHT

| | | | | | | | | | | | | | | |
|-----------|-------------------|--|------|-------|---------|---------|---|--|--|--|----|---------------|--------------------------------|------------|
| EL0073442 | | | 30W | | 3300lm | | - | | | | Da | 355x139 x68mm | Aluminiu + PC / Aluminium + PC | Gri / Gray |
| EL0073443 | | | 45W | | 4950lm | | - | | | | Da | 355x139 x68mm | | |
| EL0073444 | | | 60W | | 6600lm | | - | | | | | 489x208 x78mm | Aluminiu + PC / Aluminium + PC | Gri / Gray |
| EL0073446 | Corp stradal LED/ | | 75W | 6400K | 8250lm | 75x150° | - | | | | | 489x208 x78mm | | |
| EL0073447 | LED street light | | 100W | | 11000lm | | - | | | | | 489x208 x78mm | | |
| EL0073449 | | | 120W | | 13200lm | | - | | | | | 599x255 x78mm | | |
| EL0073450 | | | 150W | | 16500lm | | - | | | | | 599x255 x78mm | | |
| EL0073451 | | | 200W | | 22000lm | | - | | | | | 599x255 x78mm | | |



Corp stradal LED / LED Street light



| RO | Cod | Denumire | Putere | Temp. culoare | Flux luminos | Unghi dispersie | Echipe specială | Diametru interior braț | Tip braț | Necesita Adaptor | Dimensiune | Material | Culoare |
|----|------|----------|--------|---------------|---------------|-----------------|-------------------|------------------------|----------|------------------|------------|----------|---------|
| EN | Code | Name | Power | Color temp. | Luminous flux | Beam angle | Special equipment | Arm inner diameter | Arm type | Requires adapter | Size | Material | Color |

SOLENTIS - CORPURI STRADALE LED / LED STREET LIGHT

| | | | | | | | | | | | | | | |
|-----------|-------------------------------------|--|------|-------|---------|------|----------------------------------|-------|-------------|--|--|----------------|--------------------------------|------------|
| EL0068595 | | | 30W | | 4800lm | | | | | | | 569x230 x108mm | Aluminiu + PC / Aluminium + PC | Gri / Gray |
| EL0068596 | | | 45W | | 7200lm | | | | | | | 569x230 x108mm | | |
| EL0068597 | | | 60W | | 9600lm | | | | | | | 569x230 x108mm | | |
| EL0068598 | Corp stradal LED / LED street light | | 80W | 4000K | 12800lm | 150° | Conector ZHAGA/ DALI2/ 0-10V/NFC | ø65mm | Fix / Fixed | | | 679x288 x111mm | | |
| EL0068599 | | | 100W | | 16000lm | | | | | | | 679x288 x111mm | | |
| EL0068600 | | | 120W | | 19200lm | | | | | | | 679x288 x111mm | | |
| EL0068601 | | | 150W | | 24000lm | | | | | | | 752x308 x113mm | | |



Corp stradal LED / LED Street light



| | | | | | | | | | | | | | | |
|-----------|------------------------------------|--|------|-------|---------|------|---|--|--|--|----------|---------------|--------------------------------|------------|
| EL0068041 | | | 20W | | 2600lm | | - | | | | | 430x176 x70mm | Aluminiu + PC / Aluminium + PC | Gri / Gray |
| EL0068042 | | | 30W | | 3900lm | | - | | | | | 430x176 x70mm | | |
| EL0068043 | | | 45W | | 5850lm | | - | | | | | 430x176 x70mm | | |
| EL0068044 | Corp stradal LED/ LED street light | | 60W | 4000K | 7800lm | 150° | - | | | | Da / Yes | 480x200 x73mm | | |
| EL0068045 | | | 80W | | 10400lm | | - | | | | | 480x200 x73mm | | |
| EL0068046 | | | 100W | | 13000lm | | - | | | | | 560x235 x80mm | | |
| EL0068047 | | | 120W | | 15600lm | | - | | | | | 560x235 x80mm | | |



Corp stradal LED / LED Street light



| RO | Cod | Denumire | Putere | Temp. culoare | Flux luminos | Unghi dispersie | Echipare specială | Diametru interior braț | Tip braț | Necesita Adaptor | Dimensiune | Material | Culoare |
|----|------|----------|--------|---------------|---------------|-----------------|-------------------|------------------------|----------|------------------|------------|----------|---------|
| EN | Code | Name | Power | Color temp. | Luminous flux | Beam angle | Special equipment | Arm inner diameter | Arm type | Requires adapter | Size | Material | Color |

SOLENTIS - CORPURI STRADALE LED / LED STREET LIGHT

| | | | | | | | | | | | | | |
|-----------|--|--|------|-------|---------|------|---------------|-------|-------------|----------|--------------|--------------------------------|------------|
| EL0068618 | | | 30W | | 4200lm | | | | | | 430x176x70mm | Aluminiu + PC / Aluminium + PC | Gri / Gray |
| EL0068619 | | | 45W | | 6300lm | | | | | | 430x176x70mm | | |
| EL0068620 | Corp stradal LED programabil/ Programmable LED street light | | 60W | | 8400lm | | | | | | 480x200x73mm | | |
| EL0068621 | | | 80W | 4000K | 11200lm | 150° | Dimabil 0-10V | ø55mm | Fix / Fixed | Da / Yes | 480x200x73mm | | |
| EL0068622 | | | 100W | | 14000lm | | | | | | 560x235x80mm | | |
| EL0068623 | | | 120W | | 16800lm | | | | | | 560x235x80mm | | |
| EL0068624 | | | 150W | | 21000lm | | | | | | 560x235x80mm | | |



Corp stradal LED programabil / Programmable LED street light



| RO | Cod | Denumire | Putere | Temp. culoare | Flux luminos | Unghi dispersie | Echipare specială | Diametru interior braț | Tip braț | Unghi reglare braț | Necesita Adaptor | Dimensiune | Material | Culoare |
|----|------|----------|--------|---------------|---------------|-----------------|-------------------|------------------------|----------|----------------------|------------------|------------|----------|---------|
| EN | Code | Name | Power | Color temp. | Luminous flux | Beam angle | Special equipment | Arm inner diameter | Arm type | Arm adjustment angle | Requires adapter | Size | Material | Color |

HOMELIGHT - CORPURI STRADALE LED / LED STREET LIGHT

| | | | | | | | | | | | | | | |
|-----------|---------------------------------------|--|------|-------|---------|---------|--|-------|-----------------------|-----------------|---|--------------|--------------------------------|----------------------|
| EL0081270 | | | 30W | | 3600lm | | | | | | | 409x106x50mm | Aluminiu + PC / Aluminium + PC | Gri AZKO / Gray AZKO |
| EL0081271 | Corp stradal LED/ LED street light | | 50W | | 6000lm | | | | | | | 456x120x55mm | | |
| EL0081273 | | | 30W | 6500K | 3600lm | 75x130° | Senzor Crepuscular/ Twilight sensor | ø64mm | Reglabil / Adjustable | -25° - 0 - +15° | Nu - Montaj pe consolă ø60 / No - Mounting on ø60 console | 456x120x55mm | | |
| EL0084950 | | | 100W | | 12000lm | | | | | | | 144x527x84mm | | |



Corp stradal LED Homelight / LED street light Homelight

| RO | Cod | Denumire | Tip produs | Unghi ajustare | Compatibilitate | Diametrul | Culoare |
|----|------|----------|---------------|------------------|-----------------|-----------|---------|
| EN | Code | Name | Products type | Adjustment angle | Compatibility | Diameter | Color |

NOVELITE - ACCESORII CORPURI STRADALE ȘI PIETONALE / STREET AND PEDESTRIAN LIGHT ACCESSORIES

| | | | | | | |
|-----------|---|-------------|---|---|---------|------------|
| EL0038799 | Adaptor corp stradal / Street light adapter | Fix / Fixed | - | Novelite 30W&45W și LUMIO toată gama / Novelite 30W&45W and LUMIO all range | 42-60mm | Gri / Gray |
|-----------|---|-------------|---|---|---------|------------|



Adaptor corp stradal Novelite / Novelite Street light adapter

SOLENTIS - ACCESORII CORPURI STRADALE ȘI PIETONALE / STREET AND PEDESTRIAN LIGHT ACCESSORIES

| | | | | | | |
|-----------|--------------------------------|-----------------------|----------------|---|---------|------------|
| EL0031199 | Braț reglabil / Adjustable arm | Reglabil / Adjustable | 0°-30°-60°-90° | QUANTA și altele + adaptor / QUANTA and other + adaptor | 60-68mm | Gri / Gray |
| EL0080407 | | | 0°-30°-60°-90° | | | |



EL0031199



EL0080407



CORPURI DE ILUMINAT DECORATIVE

SURSE

SMART HOME

APARATAJ

CONECTICĂ

PROTECȚII

CORPURI DE ILUMINAT TEHNICE

TRASEE

CABLURI

DECORATIVE LIGHTING FIXTURES

SOURCES

SMART HOME

SWITCHES AND SOCKETS

CONNECTORS

POWER AUTOMATION

TECHNICAL LIGHTNING FIXTURES

CABLE MANAGEMENT SYSTEMS

CABLES



STÂLPI DE ILUMINAT

LIGHTING POLES

RO

Stâlpii de iluminat sunt o soluție esențială pentru spațiile exterioare, oferind siguranță și vizibilitate în locuri precum alei, parcuri, grădini, parcuri și zone publice. Pe lângă rolul lor funcțional, aceștia contribuie la estetica urbană și ambientală, integrându-se armonios în orice peisaj.

REPERE

- **Design versatil** – disponibili într-o varietate de stiluri și dimensiuni pentru a se potrivi perfect oricărui tip de spațiu;
- **Construcție durabilă** – fabricați din materiale rezistente la intemperii, coroziune și uzură, pentru o utilizare îndelungată;
- **Atmosferă plăcută** – contribuie la conturarea unui ambient confortabil și estetic în spațiile publice sau private.

EN

Lighting poles are an essential solution for outdoor spaces, providing safety and visibility in places such as alleys, parks, gardens, parking lots and public areas. In addition to their functional role, they contribute to urban and environmental aesthetics, integrating harmoniously into any landscape.

FEATURES

- **Versatile design** – available in a variety of styles and sizes to perfectly fit any type of space;
- **Durable construction** – made from weather, corrosion and wear-resistant materials for long-term use;
- **Pleasant atmosphere** – contributes to creating a comfortable and aesthetic environment in public or private spaces.

| RO | Cod | Denumire | Material | Tip material | Înălțime | Grosime material | Diametru bază | Dimensiuni flansă (distanța dintre găuri) | Diametru vârf | Compatibilitate buloane | Culoare |
|----|------|----------|----------|---------------|----------|--------------------|---------------|---|---------------|-------------------------|---------|
| EN | Code | Name | Material | Material type | Height | Material thickness | Base diameter | Flange size (distance between holes) | Peak diameter | Anchorage kit | Color |

SOLENTIS - STÂLPI GRĂDINĂ CU FLANȘĂ / GARDEN POLES WITH FLANGE

| | | | | | | | | | | | |
|-----------|-----------------------------|---|------|--|----|-----|-------------|-------------------------|------------|-----------|-------------------------------|
| EL0075272 | | | | | 3m | | ø89x1000 mm | | 60x3000 mm | | Gri RAL7045 / Gray RAL7054 |
| EL0075273 | Stâlp grădină / Garden pole | Oțel Vopsit electrostatic / Electrostatic painted steel | Q235 | | 4m | 2mm | ø89x1000 mm | 180x180x6mm (140x140mm) | 60x2000 mm | EL0075275 | Negru RAL9005 / Black RAL9005 |
| EL0075274 | | | | | 4m | | ø89x1000 mm | | 60x3000 mm | | |

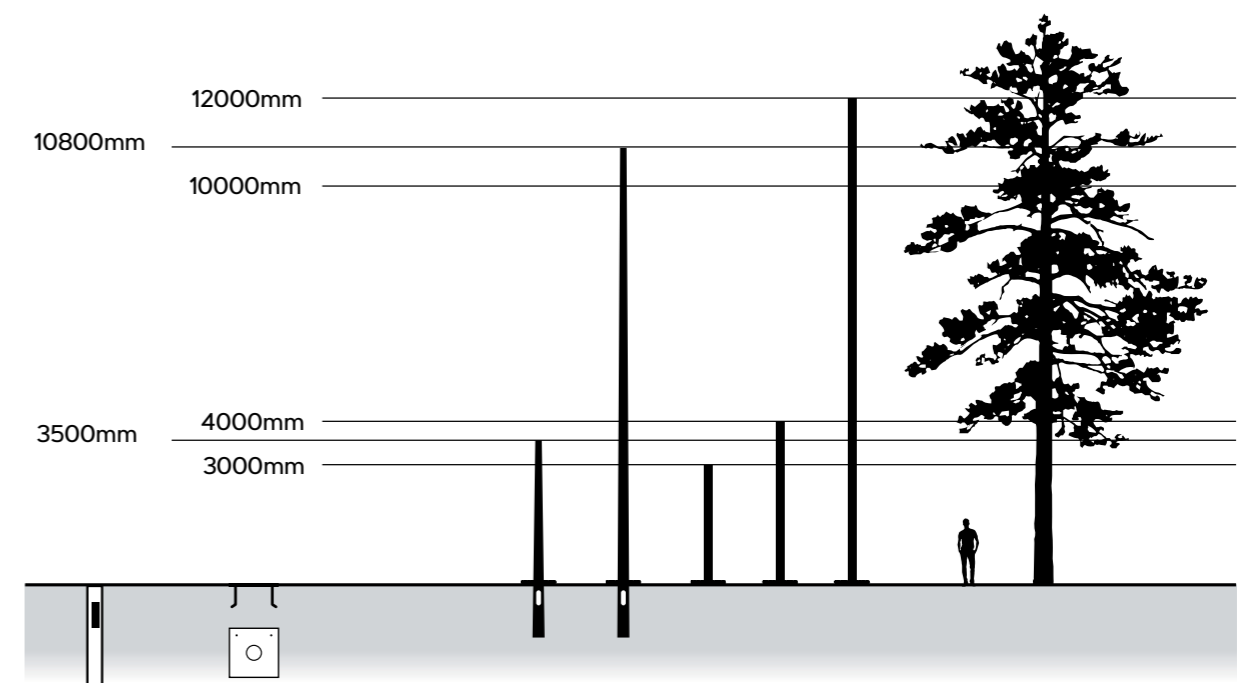

| RO | Cod | Denumire | Material | Tip material | Înălțime | Grosime material | Diametru bază | Dimensiuni flansă (distanța dintre găuri) | Diametru vârf | Compatibilitate buloane |
|----|------|----------|----------|---------------|----------|--------------------|---------------|---|---------------|-------------------------|
| EN | Code | Name | Material | Material type | Height | Material thickness | Base diameter | Flange size (distance between holes) | Peak diameter | Anchorage kit |

SOLENTIS - STÂLPI CONICI CU FLANȘĂ / CONICAL POLES WITH FLANGE

| | | | | | | | | | | |
|-----------|--|-------|--------|--|-----|-------|--------|--------------------------|---|-----------|
| EL0026769 | | | | | 3m | | ø91mm | 250x250x8mm (176x176mm) | | EL0019081 |
| EL0024443 | | | | | 4m | | ø102mm | | | EL0019081 |
| EL0019086 | | | | | 5m | | ø113mm | 250x250x10mm (176x176mm) | | EL0019081 |
| EL0017653 | | | | | 6m | 3mm | ø124mm | | | EL0019081 |
| EL0019087 | Stâlp conic cu flanșă / Conical pole with flange | OL-ZN | S235JR | | 7m | | ø135mm | 280x280x10mm (198x198mm) | 60mm+ reducere 48mm / 60mm + reduction 48mm | EL0026774 |
| EL0017654 | | | | | 8m | | ø146mm | | | EL0026774 |
| EL0026770 | | | | | 9m | | ø157mm | 280x280x12mm (198x198mm) | | EL0026774 |
| EL0026771 | | | | | 10m | | ø168mm | 320x320x14mm (226x226mm) | | EL0019088 |
| EL0026772 | | | | | 11m | 3.5mm | ø179mm | | | EL0019088 |
| EL0026773 | | | | | 12m | | ø190mm | 320x320x16mm (226x226mm) | | EL0019088 |

| RO | Cod | Denumire | Material | Tip material | Înălțime | Grosime material | Diametru bază | Dimensiuni flansă (distanța dintre găuri) | Diametru vârf | Compatibilitate buloane |
|----|------|----------|----------|---------------|----------|--------------------|---------------|---|---------------|-------------------------|
| EN | Code | Name | Material | Material type | Height | Material thickness | Base diameter | Flange size (distance between holes) | Peak diameter | Anchorage kit |

SOLENTIS - STÂLPI OCTOGONALI CU FLANȘĂ / OCTOGONAL POLES WITH FLANGE

| | | | | | | | | | | |
|-----------|--|-------|--------|--|-----|-------|--------|--------------------------|---|-----------|
| EL0029816 | | | | | 4m | | ø102mm | 250x250x10mm (176x176mm) | | EL0019081 |
| EL0029817 | | | | | 5m | | ø113mm | 250x250x10mm (176x176mm) | | EL0019081 |
| EL0027845 | | | | | 6m | | ø124mm | 250x250x10mm (176x176mm) | | EL0019081 |
| EL0029818 | Stâlp octogonal cu flanșă / Octagonal pole with flange | OL-ZN | S235JR | | 7m | 3mm | ø135mm | 250x250x10mm (176x176mm) | 60mm+ reducere 48mm / 60mm + reduction 48mm | EL0019081 |
| EL0027846 | | | | | 8m | | ø146mm | 280x280x10mm (198x198mm) | | EL0026774 |
| EL0027847 | | | | | 9m | | ø157mm | 280x280x12mm (198x198mm) | | EL0026774 |
| EL0027848 | | | | | 10m | | ø168mm | 320x320x14mm (226x226mm) | | EL0019088 |
| EL0074537 | | | | | 12m | 3.5mm | ø190mm | 320x320x16mm (226x226mm) | | EL0019088 |



| RO | Cod | Denumire | Material | Tip material | Lungime braț (A) | Grosime material | Diametru țevă - partea spre stâlp | Diametru țevă - partea spre corpul de iluminat | Înclinare (B) | Compatibilitate stâlp |
|----|------|----------|----------|---------------|------------------|--------------------|-----------------------------------|--|---------------|-----------------------|
| EN | Code | Name | Material | Material type | Arm length | Material thickness | Pipe diameter - pole side | Pipe diameter - fixture side | Tilt | Pole compatibility |

SOLENTIS - BRAȚE ȘI ACCESORII STĂLPI / POLE ARMS AND ACCESSORIES

| | | | | | | | | | | |
|-----------|---|-------|------|------|------|------|------|-----|--|--|
| EL0029808 | | | | | 0.5m | | | | | Stâlp conic octogonal / Octagonal conical pole |
| EL0029809 | Braț simplu drept / Single straight arm | OL-ZN | Q235 | 1m | 2mm | 60mm | 60mm | 15° | | |
| EL0029810 | | | | 1.5m | | | | | | |

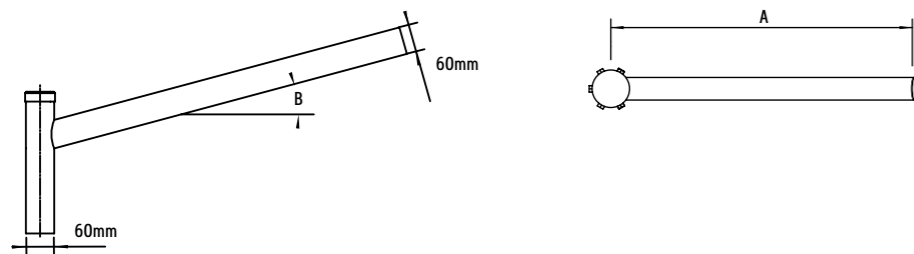

SOLENTIS - BRAȚE ȘI ACCESORII STĂLPI / POLE ARMS AND ACCESSORIES

| | | | | | | | | | |
|-----------|--|-------|------|------|-----|------|------|-----|--|
| EL0019091 | Braț simplu curbat / Single curved arm | OL-ZN | Q235 | 1m | 2mm | 60mm | 60mm | 15° | Stâlp conic octogonal / Octagonal conical pole |
| EL0028009 | | | | 1.5m | | | | | |

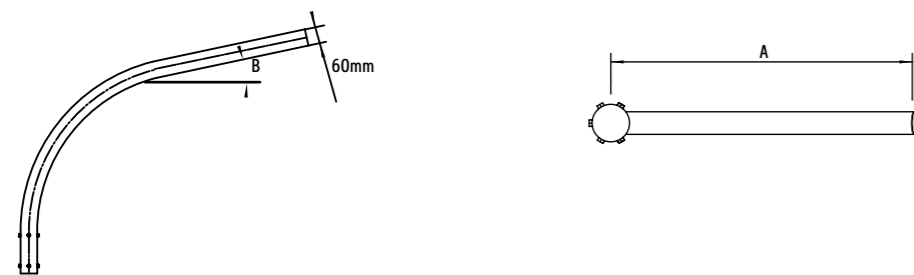

SOLENTIS - BRAȚE ȘI ACCESORII STĂLPI / POLE ARMS AND ACCESSORIES

| | | | | | | | | | |
|-----------|--|-------|------|------|-----|------|------|-----|--|
| EL0029802 | | | | 0.5m | | | | | Stâlp conic octogonal / Octagonal conical pole |
| EL0029803 | Braț dublu drept 90° / Double straight arm 90° | OL-ZN | Q235 | 1m | 2mm | 60mm | 60mm | 15° | |
| EL0029804 | | | | 1.5m | | | | | |

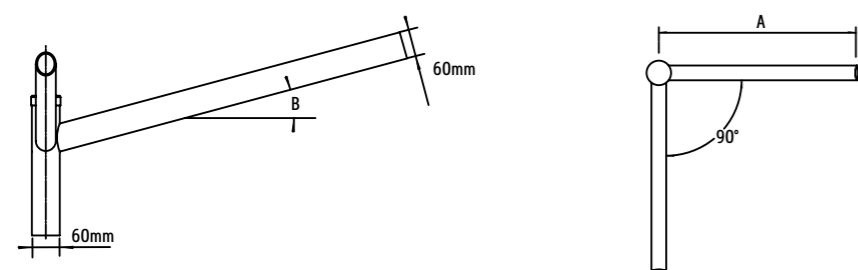

| RO | Cod | Denumire | Material | Tip material | Lungime braț | Grosime material | Diametru țevă - partea spre stâlp | Diametru țevă - partea spre corpul de iluminat | Înclinare | Compatibilitate stâlp |
|----|------|----------|----------|---------------|--------------|--------------------|-----------------------------------|--|-----------|-----------------------|
| EN | Code | Name | Material | Material type | Arm length | Material thickness | Pipe diameter - pole side | Pipe diameter - fixture side | Tilt | Pole compatibility |

SOLENTIS - BRAȚE ȘI ACCESORII STĂLPI / POLE ARMS AND ACCESSORIES

| | | | | | | | | | |
|-----------|---|-------|------|------|-----|------|------|-----|--|
| EL0024111 | Braț dublu curbat 90° / Double curved arm 90° | OL-ZN | Q235 | 1m | 2mm | 60mm | 60mm | 15° | Stâlp conic octogonal / Octagonal conical pole |
| EL0028023 | | | | 1.5m | | | | | |

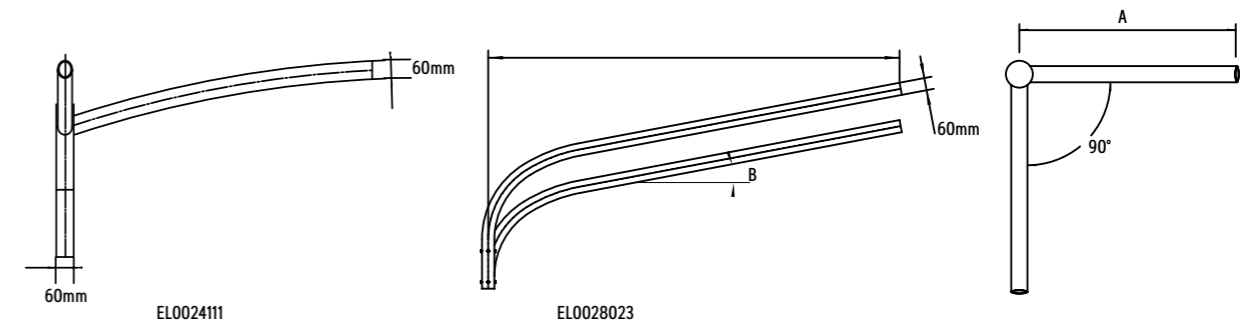

SOLENTIS - BRAȚE ȘI ACCESORII STĂLPI / POLE ARMS AND ACCESSORIES

| | | | | | | | | | |
|-----------|--|-------|------|------|-----|------|------|-----|--|
| EL0029805 | | | | 0.5m | | | | | Stâlp conic octogonal / Octagonal conical pole |
| EL0029806 | Braț dublu drept 180° / Double straight arm 180° | OL-ZN | Q235 | 1m | 2mm | 60mm | 60mm | 15° | |
| EL0029807 | | | | 1.5m | | | | | |

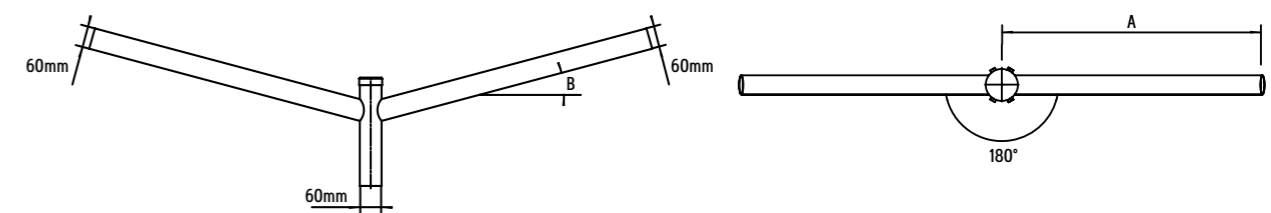

SOLENTIS - BRAȚE ȘI ACCESORII STĂLPI / POLE ARMS AND ACCESSORIES

| | | | | | | | | | |
|-----------|---|-------|------|----|-----|------|------|-----|--|
| EL0019092 | Braț dublu curbat 180° / Double curved arm 180° | OL-ZN | Q235 | 1m | 2mm | 60mm | 60mm | 15° | Stâlp conic octogonal / Octagonal conical pole |
|-----------|---|-------|------|----|-----|------|------|-----|--|

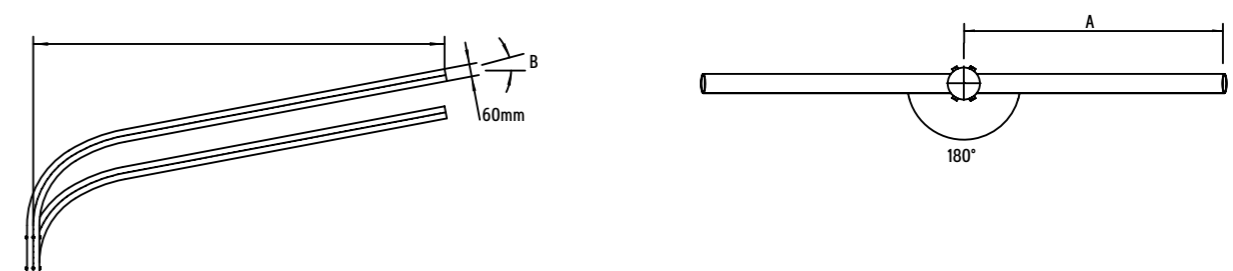

| RO | Cod | Denumire | Material | Tip material | Lungime braț | Grosime material | Diametru țevă - partea spre stâlp | Diametru țevă - partea spre corpul de iluminat | Înclinare | Compatibilitate stâlp |
|----|------|----------|----------|---------------|--------------|--------------------|-----------------------------------|--|-----------|-----------------------|
| EN | Code | Name | Material | Material type | Arm length | Material thickness | Pipe diameter - pole side | Pipe diameter - fixture Side | Tilt | Pole compatibility |

SOLENTIS - BRAȚE ȘI ACCESORII STÂLPI / POLE ARMS AND ACCESSORIES

| | | | | | | | | | |
|-----------|---|-------|------|------|-----|------|------|-----|--|
| EL0029811 | Braț triplu drept 120° / Triple straight arm 120° | OL-ZN | Q235 | 0.5m | 2mm | 60mm | 60mm | 15° | Stâlp conic octogonal / Octagonal conical pole |
| EL0029812 | | | | 1m | | | | | |
| EL0029813 | | | | 1.5m | | | | | |

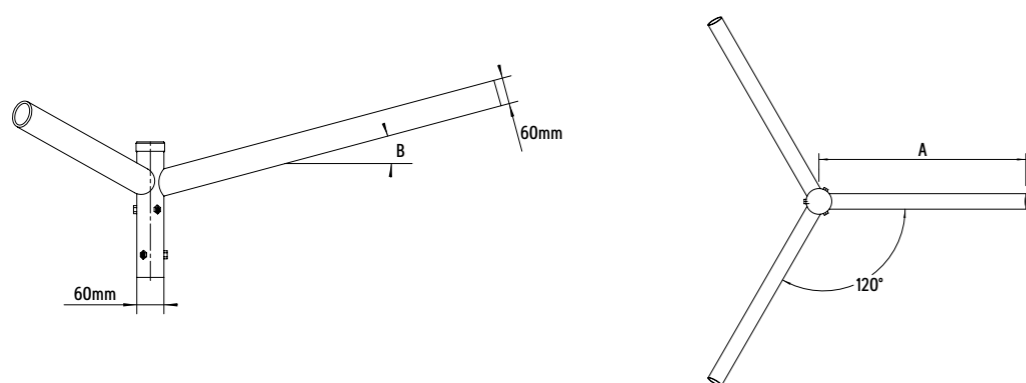

SOLENTIS - BRAȚE ȘI ACCESORII STÂLPI / POLE ARMS AND ACCESSORIES

| | | | | | | | | | |
|-----------|--|-------|------|----|-----|------|------|-----|--|
| EL0028008 | Braț triplu curbat 120° / Triple curved arm 120° | OL-ZN | Q235 | 1m | 2mm | 60mm | 60mm | 15° | Stâlp Conic octogonal / Octagonal conical pole |
|-----------|--|-------|------|----|-----|------|------|-----|--|

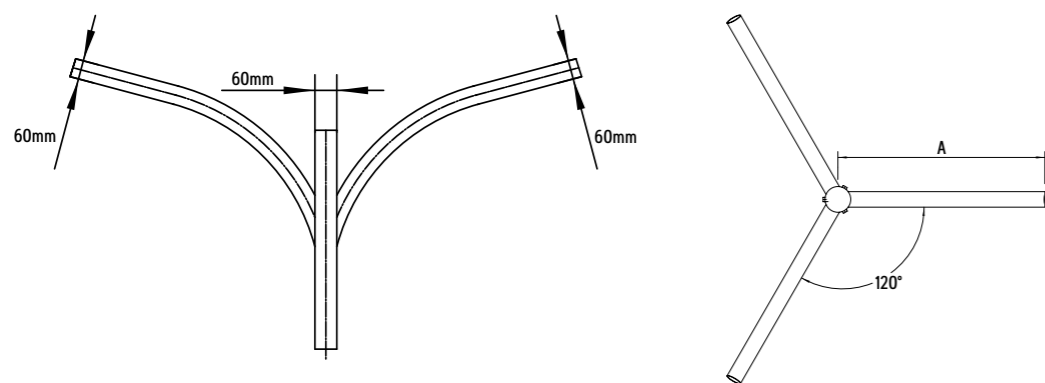

| RO | Cod | Denumire | Dimensiuni șurub | Dimensiuni șablon (Distanța dintre găuri) | Compatibilitate stâlp |
|----|------|----------|------------------|---|-----------------------|
| EN | Code | Name | Screw size | Distance between holes | Pole compatibility |

SOLENTIS - BRAȚE ȘI ACCESORII STÂLPI / POLE ARMS AND ACCESSORIES

| | | | | |
|-----------|-----------------------------|--|----------------------|--|
| EL0019081 | Set buloane / Anchorage KIT | 4xM14x500mm | 250x250mm(176x176mm) | Stâlp octogonal/conic 3-6m / Octagonal/conical pole 3-6m |
| EL0026774 | | 4xM16x600mm | 280x280mm(198x198mm) | Stâlp octogonal/conic 7-9m / Octagonal/conical pole 7-9m |
| EL0019088 | | 4xM18x800mm/M18x1200mm (pentru stâlp 12m / for 12m pole) | 320x320mm(226x226mm) | Stâlp octogonal/conic 10-12m / Octagonal/conical pole 10-12m |
| EL0075275 | | 4xM12x400mm | 180x180mm(140x140mm) | Stâlp grădină 3-4m / Garden pole 3-4m |



CORPURI ARHITECTURALE ARCHITECTURAL LIGHT FIXTURES

RO

Corpurile arhitecturale sunt soluții de iluminat special concepute pentru a evidenția și îmbunătăți designul arhitectural al clădirilor, monumentelor și spațiilor publice. Acestea includ proiectoare LED RGB și spoturi LED pietonale, care oferă opțiuni de iluminare versatile, cu efecte de culoare și unghiuri de iluminare precise. Ideal pentru crearea unei atmosfere unice, aceste corpuri sunt utilizate pentru a pune în valoare detalii arhitecturale și pentru a adăuga un plus de estetică la orice proiect de iluminat exterior.

REPERE

- **Iluminare RGB** - posibilitatea de a ajusta culorile, pentru a crea efecte vizuale dinamice și personalizate;
- **Design discret și eficient** - spoturi și proiectoare compacte, ușor de integrat în diverse spații arhitecturale;
- **Tehnologie LED de ultimă generație** - durabilitate crescută, consum redus de energie și iluminare constantă pe termen lung.

EN

Architectural fixtures are lighting solutions specially designed to highlight and enhance the architectural design of buildings, monuments, and public spaces. These include RGB LED floodlights and pedestrian LED spotlights, offering versatile lighting options with color effects and precise lighting angles. Ideal for creating a unique atmosphere, these fixtures are used to emphasize architectural details and add an aesthetic touch to any outdoor lighting project.

FEATURES

- **RGB lighting** - the ability to adjust colors to create dynamic and customized visual effects;
- **Discreet and efficient design** - compact spotlights and floodlights, easy to integrate into various architectural spaces;
- **Cutting-edge LED technology** - increased durability, reduced energy consumption, and long-term consistent lighting.



| RO | Cod | Denumire | Putere | Dimensiune | Material |
|----|------|----------|--------|------------|----------|
| EN | Code | Name | Power | Size | Material |

NOVELITE - PROIECTOARE ARHITECTURALE LED / ARCHITECTURAL LED FLOODLIGHT

| | | | | |
|-----------|--|------|--------------|--|
| EL0075714 | Proiector LED RGB / RGB LED floodlights | 30W | 150x30x115mm | Aluminiu + Sticlă / Aluminium + Glass |
| EL0075715 | | 50W | 195x30x140mm | |
| EL0075716 | | 100W | 261x32x195mm | |



Proiector LED RGB Novelite /
Novelite RGB LED floodlights



| RO | Cod | Denumire | Putere | Destinație | Dimensiune | Material |
|----|------|----------|--------|-------------|------------|----------|
| EN | Code | Name | Power | Destination | Size | Material |

NOVELITE - SPOTURI PIETONALE LED / LED PEDESTRIAN SPOTLIGHTS

| | | | | | |
|-----------|---|-----|---|-----------|--|
| EL0075729 | Spot pietonal LED / LED pedestrian spotlight | 3W | Pardoseală / Pavaj Flooring / Paving | ø80x72mm | Oțel + Sticlă securizată / Steel + Tempered glass |
| EL0075734 | | 9W | | ø150x90mm | |
| EL0075735 | | 12W | | ø160x90mm | |
| EL0075736 | | 18W | | ø180x90mm | |



Spot pietonal LED Novelite /
Novelite LED pedestrian spotlight



CORPURI SOLARE SOLAR FIXTURES

RO

Corpurile solare sunt soluții inovatoare pentru iluminarea exterioară, alimentate de energie solară, fiind potrivite pentru zonele cu acces limitat la rețeaua electrică sau pentru a reduce costurile de operare. Acestea sunt disponibile în variante pietonale, stradale și proiectoare. Cu tehnologii avansate de panou solar (monocristalin și policristalin), corpurile solare oferă performanță de înaltă calitate, indiferent de condițiile meteorologice.

REPERE

- **Tehnologie panou monocristalin/policristalin** - eficiență mare în captarea energiei solare, asigurând încărcare rapidă și iluminare constantă;
- **Grad de protecție IP65** - rezistente la apă și praf, fiind ideale pentru utilizarea în medii externe cu condiții dificile;
- **Temperatură de culoare rece** - lumina rece asigură vizibilitate sporită și eficiență energetică, oferind un iluminat clar și precis.

EN

Solar fixtures are innovative solutions for outdoor lighting, powered by solar energy, suitable for areas with limited access to the electrical grid or to reduce operating costs. They are available in pedestrian, street, and floodlight versions. With advanced solar panel technologies (monocrystalline and polycrystalline), solar fixtures offer high-quality performance regardless of weather conditions.

FEATURES

- **Monocrystalline/Polycrystalline panel technology** - high efficiency in capturing solar energy, ensuring fast charging and consistent lighting;
- **IP65 protection rating** - water and dust-resistant, ideal for use in outdoor environments with harsh conditions;
- **Cool color temperature** - cool light ensures enhanced visibility and energy efficiency, providing clear and precise illumination.



| RO | Cod | Denumire | Putere echivalentă | Temperatură culoare | Flux luminos | Tehnologie panou | Putere panou solar | Specificații acumulator | Material | Dimensiuni produs | Dimensiuni panou solar | Culoare | Echipeare |
|----|------|----------|--------------------|---------------------|---------------|------------------|--------------------|-------------------------|----------|-------------------|------------------------|---------|-----------|
| EN | Code | Name | Equivalent power | Color temperature | Luminous flux | Panel technology | Solar panel power | Battery specifications | Material | Product size | Solar panel size | Color | Equipment |

NOVELITE - CORPURI SOLARE PIETONALE LED / LED PEDESTRIAN SOLAR LIGHTS

| | | | | | | | | | | | | |
|-----------|---|------|-------|--------|---------------------------------|-----|--------------|-----|------------|---------------------|---------------|-----------------------|
| EL0078640 | Corp solar pietonal LED / LED pedestrian solar lights | 150W | 6400K | 1650lm | Monocristalin / Monocrystalline | 24W | LiFePO4 20Ah | ABS | ø555x125mm | Integrat / Built-in | Negru / Black | Senzor MW / MW Sensor |
|-----------|---|------|-------|--------|---------------------------------|-----|--------------|-----|------------|---------------------|---------------|-----------------------|



Corp solar pietonal LED Novelite / Novelite LED pedestrian solar lights



| RO | Cod | Denumire | Putere echivalentă | Temperatură culoare | Flux luminos | Tehnologie panou | Putere panou solar | Specificații acumulator | Material | Dimensiuni produs | Dimensiuni panou solar | Culoare | Echipeare |
|----|------|----------|--------------------|---------------------|---------------|------------------------|--------------------|-------------------------|----------|-------------------|------------------------|---------|-----------|
| EN | Code | Name | Equivalent power | Color temperature | Luminous flux | Solar panel technology | Solar panel power | Battery specifications | Material | Product size | Solar panel size | Color | Equipment |

SOLENTIS - CORPURI SOLARE PIETONALE LED / LED PEDESTRIAN SOLAR LIGHTS

| | | | | | | | | | | | | |
|-----------|---|------|-------|--------|---------------------------------|-----|--------------|---------|------------|---------------------|------------|-----------------------|
| EL0078638 | Corp solar pietonal LED / LED pedestrian solar lights | 300W | 6400K | 3000lm | Monocristalin / Monocrystalline | 25W | LiFePO4 25Ah | Al + PC | ø610x189mm | Integrat / Built-in | Gri / Gray | Senzor MW / MW Sensor |
|-----------|---|------|-------|--------|---------------------------------|-----|--------------|---------|------------|---------------------|------------|-----------------------|



Corp solar pietonal LED Solentis / Solentis LED pedestrian solar lights



| RO | Cod | Denumire | Putere echivalentă | Temperatură culoare | Flux luminos | Tehnologie panou | Putere panou solar | Specificații acumulator | Material | Dimensiuni produs | Dimensiuni panou solar | Culoare | Echipeare |
|----|------|----------|--------------------|---------------------|---------------|------------------------|--------------------|-------------------------|----------|-------------------|------------------------|---------|-----------|
| EN | Code | Name | Equivalent power | Color temperature | Luminous flux | Solar panel technology | Solar panel power | Battery specifications | Material | Product size | Solar panel size | Color | Equipment |

NOVELITE - CORPURI SOLARE PIETONALE LED / LED PEDESTRIAN SOLAR LIGHTS

| | | | | | | | | | | | | | |
|-----------|--|--|-------|--------|--------|---------------------------------|--------------|--------------|-----|------------------------------|----------------|---------------|------------------------------|
| EL0071371 | | | 30W | 6500K | 350lm | | 6W | LiFePO4 5Ah | | | 195x53x390mm | | |
| EL0071372 | | | 60W | 6500K | 650lm | Policristalin / Polycrystalline | 8W | LiFePO4 10Ah | ABS | Integrat / Built-in | 220x55x485mm | Negru / Black | Senzor MW / MW Sensor |
| EL0071373 | | Corp solar stradal LED / LED street solar lights | 90W | 6500K | 1000lm | | 12W | LiFePO4 15Ah | | | 240x620x60mm | | |
| EL0071374 | | 120W | 6500K | 1350lm | 15W | | LiFePO4 18Ah | 240x820x65mm | | | | | |
| EL0075741 | | | 150W | 6500K | 1600lm | | 18W | LiFePO4 20Ah | | | | | |
| EL0075742 | | | 300W | 6400K | 4000lm | Monocristalin / Monocrystalline | 30W | LiFePO4 30Ah | ACC | Telecomandă / Remote control | 533.5x215x79mm | Negru / Black | Telecomandă / Remote control |
| EL0075743 | | | 500W | 6400K | 6000lm | | 60W | LiFePO4 50Ah | | | 390x700x16mm | | |



Corp solar stradal LED Novelite / Novelite LED street solar lights



| RO | Cod | Denumire | Putere echivalentă | Temperatură culoare | Flux luminos | Tehnologie panou | Putere panou solar | Specificații acumulator | Material | Dimensiuni produs | Dimensiuni panou solar | Culoare | Echipeare |
|----|------|----------|--------------------|---------------------|---------------|------------------------|--------------------|-------------------------|----------|-------------------|------------------------|---------|-----------|
| EN | Code | Name | Equivalent power | Color temperature | Luminous flux | Solar panel technology | Solar panel power | Battery specifications | Material | Product size | Solar panel size | Color | Equipment |

NOVELITE - PROIECTOARE SOLARE LED / LED SOLAR FLOORING

| | | | | | | | | | | | | | | |
|-----------|--|--|------|-------|--------|---------------------------------|-----|--------------|----|------------------------------|--------------|---------------|------------|--------------|
| EL0071375 | | | 50W | | 520lm | | 6W | LiFePO4 5Ah | | | 210x175x50mm | | | |
| EL0071376 | | Proiector solar LED v1 / LED solar flooring v1 | 100W | | 1000lm | Monocristalin / Monocrystalline | 12W | LiFePO4 10Ah | AI | Telecomandă / Remote control | 260x200x50mm | Negru / Black | Gri / Gray | |
| EL0075752 | | | 50W | 6400K | 500lm | | 6W | LiFePO4 4Ah | | | 180x138x38mm | | | 210x200x17mm |
| EL0075754 | | Proiector solar LED v2 / LED solar flooring v2 | 100W | | 1000lm | | 10W | LiFePO4 10Ah | | | 225x175x48mm | | | 340x210x17mm |
| EL0075755 | | | 200W | | 2500lm | | 20W | LiFePO4 20Ah | | | 275x218x48mm | | | |
| EL0075757 | | | 300W | | 3600lm | | 30W | LiFePO4 30Ah | | | 330x255x48mm | | | |
| | | | | | | | | | | | 430x390x17mm | | | |



Proiector solar LED v1 / LED solar flooring v1



Proiector solar LED v2 / LED solar flooring v2



ILUMINAT EMERGENȚĂ EMERGENCY LIGHTING

RO

Iluminatul de urgență este esențial pentru siguranța persoanelor în caz de pană de curent. Acesta se activează automat, oferă iluminare temporară ghidând persoanele către ieșirile de urgență, prevenind panica și accidentele. Potrivit pentru orice tip de clădire, acesta asigură o evacuare rapidă și sigură.

REPERE

- **Siguranță sporită** – activare automată și evacuare eficientă în caz de întrerupere a curentului;
- **Durabilitate** – performanță fiabilă pe termen lung, chiar și în utilizare intensă;
- **Eficiență** – baterii de durată și consum redus, pentru funcționare continuă în situații critice.

EN

Emergency lighting is essential for ensuring safety during a power outage. It activates automatically, provides temporary illumination, and guides people toward emergency exits, helping prevent panic and accidents. Suitable for any type of building, it ensures quick and safe evacuation.

FEATURES

- **Enhanced safety** – automatic activation and efficient evacuation during power failure;
- **Durability** – reliable long-term performance, even under heavy use;
- **Efficiency** – long-lasting batteries and low energy consumption for continuous operation in critical situations.

LED IP40 230V

| RO | Cod | Denumire | Montaj | Funcționare | Autonomie | Putere | Specificații acumulator | Dimensiune | Material |
|----|------|----------|----------|-------------|-----------|--------|-------------------------|------------|----------|
| EN | Code | Name | Mounting | Operating | Autonomy | Power | Battery specifications | Size | Material |

NOVELITE - CORPURI EMERGENȚĂ LED BASIL / LED EMERGENCY LIGHTS BASIL

| | | | | | | | | | |
|-----------|---|--------------------------|-------------------------|----|----|-----------------------|--------------|---|--|
| EL0057271 | | | | | | | | | |
| EL0057272 | | | | | | | | | |
| EL0057353 | Corp emergență LED suspendat / Suspended LED emergency light | Suspendat / Suspended | Menținut/ Maintained | 2H | 2W | Ni-Cad 1.2V 300mAh | 330x145x23mm | Metal + Sticlă + Plastic / Metal + Glass + Plastic | |
| EL0057354 | | | | | | | | | |
| EL0057355 | | | | | | | | | |
| EL0083613 | Kit susperndare BASIL / Suspended Kit BASIL | Suspendat / Suspended | - | - | - | - | - | Oțel / Steel | |



EL0057271



EL0057272



EL0057354

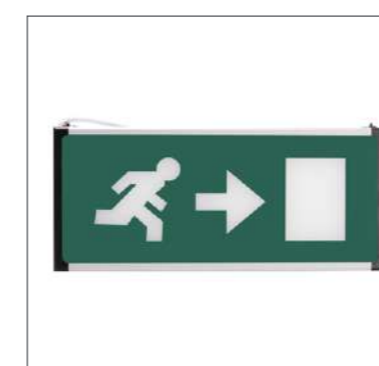

EL0057353



EL0057355

LED IP65 230V

| RO | Cod | Denumire | Montaj | Funcționare | Autonomie | Putere | Specificații acumulator | Dimensiune | Material | Accesorii incluse |
|----|------|----------|----------|-------------|-----------|--------|-------------------------|------------|----------|----------------------|
| EN | Code | Name | Mounting | Operating | Autonomy | Power | Battery specifications | Size | Material | Included accessories |

NOVELITE - CORPURI EMERGENȚĂ LED IP65 / LED EMERGENCY LIGHTS IP65

| | | | | | | | | | |
|-----------|---|----|---|----|------|---------------------|---------------|-----------|-----------------------------|
| EL0043932 | Corp emergență IP65 ODES3 / IP65 ODES13 emergency light | PT | Nemenținut / Non maintained | 3H | 3W | Ni-Cad 3.6V 1500mAh | 355x110x8.5mm | ABS + PVC | Sticker EXIT / EXIT Sticker |
| EL0039153 | Corp emergență IP65 / IP65 emergency light | PT | Menținut / nemenținut / Maintained / Non maintained | 3H | 4.6W | Ni-Cad 3.6V 1500mAh | 345x110x76mm | PC | Sticker EXIT / EXIT Sticker |



EL0043932



EL0039153

LED IP40 230V

NOVELITE - CORPURI EMERGENȚĂ LED ISMIA / ISMIA LED EMERGENCY LIGHTS

| | | | | | | | | | |
|-----------|--|----|-----------------------------|------|------|-------------------|-------------|--------------------------------------|---|
| EL0041143 | Corp emergență ISMIA 18 / ISMIA 18 emergency light | PT | Menținut / Maintained | 3.5H | 1.8W | Plumb 2x4V 800mAh | 248x78x50mm | ABS + PC | Cablu cu ștecher 1.1 m + Sticker EXIT/ |
| EL0037112 | Menținut / Maintained | | PC | | | | | Cable with plug 1.1 m + EXIT Sticker | |
| EL0057299 | Corp emergență NEW ISMIA / ISMIA NEW emergency light | | Nemenținut / Non maintained | 6-8H | 2W | Plumb 4V 1800mAh | 230x60x45mm | ABS + PVC | Cablu cu ștecher 0.1 m + Sticker EXIT/ Cable with plug 0.1 m + EXIT Sticker |



EL0041143



EL0037112



EL0057299

LED IP40 230V

| RO | Cod | Denumire | Montaj | Funcționare | Autonomie | Putere | Specificații acumulator | Dimensiune | Material | Accesorii incluse |
|----|------|----------|----------|-------------|-----------|--------|-------------------------|------------|----------|----------------------|
| EN | Code | Name | Mounting | Operating | Autonomy | Power | Battery specifications | Size | Material | Included accessories |

NOVELITE - CORPURI EMERGENȚĂ LED ODES / LED EMERGENCY LIGHTS ODES

| | | | | | | | | | |
|-----------|--|----|-----------------------------|------|-----|-------------------|-------------|-----------|-----------------------------|
| EL0043931 | Corp emergență ODES13 / ODES13 emergency light | PT | Nemenținut / Non maintained | 1.5H | 13W | Plumb 2x4V 900mAh | 246x76x51mm | ABS + PVC | Sticker EXIT / EXIT Sticker |
| EL0043930 | Corp emergență ODES16 / ODES16 emergency light | | Nemenținut / Non maintained | | | | | | |



EL0043931



EL0043930



| RO | Cod | Denumire | Montaj | Funcționare | Autonomie | Putere | Specificații acumulator | Dimensiune | Material | Accesorii incluse |
|----|------|----------|----------|-------------|-----------|--------|-------------------------|------------|----------|----------------------|
| EN | Code | Name | Mounting | Operating | Autonomy | Power | Battery specifications | Size | Material | Included accessories |

NOVELITE - CORPURI EMERGENȚĂ LED VERSO 1 / LED EMERGENCY LIGHTS VERSO 1

| | | | | | | | | | |
|-----------|---|--------------------|-----------------------|----|----|--------------------|-------------|------|--|
| EL0043931 | Corp emergență LED verso 1 / LED emergency light verso 1 | 4 Moduri / 4 Modes | Menținut / Maintained | 5H | 1W | Ni-Cad 3.6V 500mAh | 350x28mm | PVC | Kit montaj perete / tavan / Suspendat / lateral / Wall / ceiling / suspended / side mounting kit |
| EL0039211 | Display EXIT verso 1 / Exit display verso 1 | - | - | - | - | - | 340x170x4mm | PMMA | - |
| EL0039194 | Display săgeată jos verso 1 / Down arrow display verso 1 | - | - | - | - | - | | | - |
| EL0039192 | Display săgeată stânga-dreapta verso 1 / Left-right arrow display verso 1 | - | - | - | - | - | | | - |
| EL0039193 | Display săgeată sus verso 1 / Up arrow display verso 1 | - | - | - | - | - | | | - |
| EL0039195 | Display hidrant verso 1 / Hydrant display verso 1 | - | - | - | - | - | | | - |



EL0039191



EL0039211



EL0039194

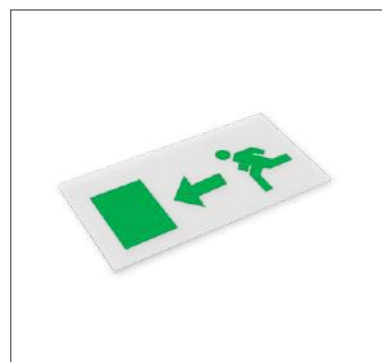

EL0039192

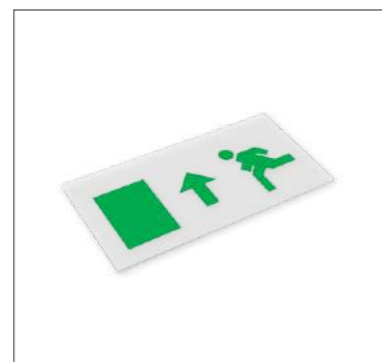

EL0039193



EL0039195



| RO | Cod | Denumire | Montaj | Funcționare | Autonomie | Putere | Specificații acumulator | Dimensiune | Material | Accesorii incluse |
|----|------|----------|----------|-------------|-----------|--------|-------------------------|------------|----------|----------------------|
| EN | Code | Name | Mounting | Operating | Autonomy | Power | Battery specifications | Size | Material | Included accessories |

NOVELITE - CORPURI EMERGENȚĂ LED VERSO 2 / LED EMERGENCY LIGHTS VERSO 2

| | | | | | | | | | |
|-----------|---|----------|-----------------------|----|------|--------------------|-------------|------|--|
| EL0039185 | Corp emergență LED verso 2 / LED emergency light verso 2 | 4 Moduri | Menținut / Maintained | 5H | 1.8W | Ni-Cad 3.6V 500mAh | 370x46mm | PVC | Kit montaj perete / tavan / suspendat / lateral / Wall / ceiling / suspended / side mounting kit |
| EL0039186 | Display EXIT verso 2 / Exit display verso 2 | - | - | - | - | - | 300x160x5mm | PMMA | - |
| EL0039189 | Display săgeată jos verso 2 / Down arrow display verso 2 | - | - | - | - | - | | | - |
| EL0039187 | Display săgeată stânga-dreapta verso 2 / Left-right arrow display verso 2 | - | - | - | - | - | | | - |
| EL0039188 | Display săgeată sus verso 2 / Up arrow display verso 2 | - | - | - | - | - | | | - |
| EL0039190 | Display hidrant verso 2 / Hydrant display verso 2 | - | - | - | - | - | | | - |



EL0039191



EL0039211

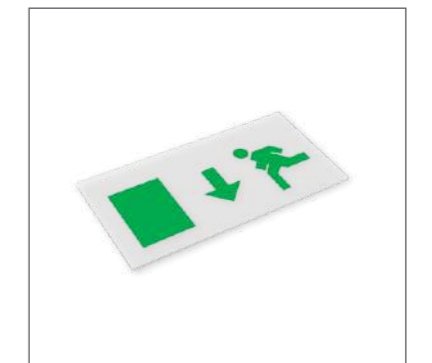

EL0039194

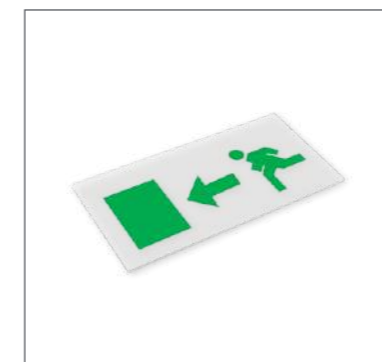

EL0039192

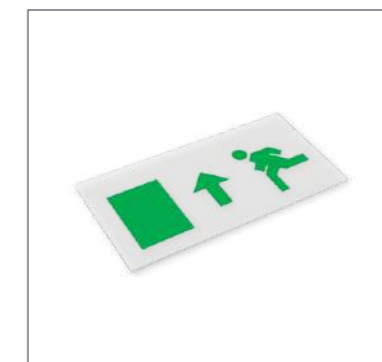

EL0039193

| RO | Cod | Denumire | Dimensiune | Compatibilitate |
|----|------|----------|------------|-----------------|
| | Code | Name | Size | Compatibility |

NOVELITE - PICTOGRAME ȘI ACCESORII EMERGENȚĂ / EMERGENCY PICTOGRAMS AND ACCESSORIES

| | | | |
|-----------|---|-----------|------------------|
| EL0060863 | Set pictograme direcționale / Directional pictogram set | 215x70mm | ODES13 / ISMIA18 |
| EL0060862 | Pictogramă hidrant / Hydrant pictogram | | |
| EL0081548 | Set pictograme direcționale / Directional pictogram set | 310x100mm | ODES3 |
| EL0082595 | Pictogramă hidrant / Hydrant pictogram | | |

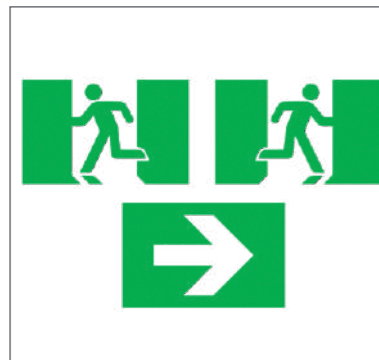

Set pictograme direcționale / Directional pictogram set



Pictogramă hidrant / Hydrant pictogram





SENZORI

SENSORS

RO

Senzorii de iluminat sunt soluții inteligente care optimizează consumul de energie și îmbunătățesc siguranța în diverse spații interioare și exterioare. De la detectarea fumului pentru protecție împotriva incendiilor, până la reglarea luminii în funcție de nivelul de întuneric sau prezența în încăpere, aceștia contribuie la reducerea consumului de energie și la creșterea confortului utilizatorilor.

REPERE

- **Eficiență energetică** - activează iluminatul doar la nevoie, contribuind semnificativ la economii;
- **Tehnologie diversă** - senzori de mișcare, crepusculari și de prezență pentru diverse aplicații;
- **Flexibilitate** - compatibili cu o gamă variată de corpuri de iluminat și ușor de instalat.

EN

Sensors are intelligent solutions that optimize energy consumption and enhance safety in various indoor and outdoor spaces. From smoke detection for fire protection to adjusting light levels based on darkness or room occupancy, they contribute to energy savings and increased comfort for users.

FEATURES

- **Energy efficiency** - activates lighting only when needed, contributing to significant savings;
- **Diverse technology** - motion, twilight, and presence sensors for various applications;
- **Flexibility** - compatible with a wide range of lighting fixtures and easy to install.

IP20

| RO | Cod | Denumire | Alimentare | Emisii detectate | Utilizare | Tip funcționare | Nivel acustic alarmă | Dimensiune | Material | Culoare |
|----|------|----------|--------------|--------------------|-----------|-----------------|----------------------|------------|----------|---------|
| EN | Code | Name | Power supply | Detected emissions | Use | Operating type | Alarm sound level | Size | Material | Color |

NOVELITE - SENZOR FUM / SMOKE SENSOR

| | | | | | | | | | |
|-----------|-------------------------------|-----------------------------|-----|---------------------|--|------|--------------|-----|-------------|
| EL0037131 | Detector fum / Smoke detector | Baterie 9VDC / Battery 9VDC | CO2 | Casnică / Household | Doar avertizare - nu declanșează / Warning only - does not trigger | 85dB | 132x126x40mm | ABS | Alb / White |
|-----------|-------------------------------|-----------------------------|-----|---------------------|--|------|--------------|-----|-------------|



Detector fum / Smoke detector

230V IP44

| RO | Cod | Denumire | Sarcină maximă | Curent maxim | Sensibilitate lumină | Material | Culoare |
|----|------|----------|----------------|-----------------|----------------------|----------|---------|
| EN | Code | Name | Maximum load | Maximum current | Light sensitivity | Material | Color |

NOVELITE - SENZORI CREPUSCULARI / TWILIGHT SENSORS

| | | | | | | |
|-----------|---|-------|-----|----------|---------|-------------|
| EL0037129 | Senzori crepusculari / Twilight Sensors | 1000W | 6A | 5-50lux | Plastic | Alb / White |
| EL0037130 | | 1200W | 10A | | | |
| EL0037128 | | 1500W | 15A | 5-100lux | | |
| EL0075142 | | 2000W | 25A | | | |



EL0037129



EL0037130



EL0037128



EL0075142

230V

| Cod | Denumire | Tip senzor | Sarcină maximă | Unghi detecție | Distanță de detecție | Înălțime maximă montaj | Reglaj Temporizare | Reglaj Crepuscul | Grad de protecție | Montaj | Dimensiune | Material | Culoare |
|--|-------------------------------------|-------------|----------------|------------------|----------------------|-------------------------|--------------------|---------------------|---------------------------|-----------------------------------|-----------------|----------|---------------|
| Code | Name | Sensor type | Maximum load | Dispersion angle | Detection distance | Maximum mounting height | Timer adjustment | Twilight adjustment | Ingress protection rating | Mounting | Size | Material | Color |
| NOVELITE - SENZORI DE MIȘCARE / MOTION DETECTION SENSOR | | | | | | | | | | | | | |
| EL0060692 | | | 1200W | 160° | 9m | 1.8m | 5sec-9min | 3-1000lux | IP20 | Doză rotundă / Round junction box | 80x50x80mm | | Alb / White |
| EL0037124 | | | 800W | 360° | 2-6m | 4m | 7sec-10min | 3-2000lux | IP65 | ST | 50x35x60mm | | Negru / Black |
| EL0042842 | | | | | | 2.5m | 10sec-15min | | | | 119.5x80x51.5mm | | Alb / White |
| EL0037121 | | | | | | | | | | PT | 83x65x95mm | Plastic | Negru / Black |
| EL0037127 | Senzori de mișcare / Motion Sensors | PIR | 1200W | 180° | 2-12m | 3.5m | 5sec-8min | 5-1000lux | IP44 | | 83x65x95mm | | Alb / White |
| EL0037126 | | | | | | | | | | | 83x65x95mm | | Negru / Black |
| EL0037119 | | | | | | 4.5m | 5sec-7min | 5-2000lux | IP20 | | ø117x51mm | | Alb / White |
| EL0037125 | | | | 360° | | | | | | | ø117x51mm | | Negru / Black |
| EL0075132 | | | 2000W | | 16m | 3.5m | 7sec-8min | 3-2000lux | IP40 | | ø115x24mm | | Alb / White |

NOVELITE - SENZOR MICROWAVE / MICROWAVE SENSOR

| | | | | | | | | | | | | | |
|-----------|-------------------------------------|-----------|-------|------|-------|------|-------------|-----------|------|----|--|---------|-------------|
| EL0075131 | Senzor microunde / Microwave sensor | Microunde | 1200W | 360° | 2-16m | 3.5m | 10sec-30sec | 2-2000lux | IP20 | PT | | Plastic | Alb / White |
|-----------|-------------------------------------|-----------|-------|------|-------|------|-------------|-----------|------|----|--|---------|-------------|



EL0037125



EL0037123



EL0037126



EL0037127



EL0037119



EL0042842



EL0037121



EL0037127



EL0075131



EL0060692



EL0037124



ACCESORII ALIMENTARE POWER SUPPLY ACCESSORIES

RO

Accesoriile sunt componente esențiale pentru buna funcționare a sistemelor de iluminat, asigurându-le alimentarea corespunzătoare și siguranța în utilizare. Acestea includ drivere LED pentru panouri și startere pentru lămpile cu tuburi fluorescente, având rolul de a controla fluxul de curent și de a proteja echipamentele de posibile avarii. Aceste accesorii sunt concepute pentru a oferi performanță constantă și eficiență în alimentarea sistemelor de iluminat.

REPERE

- **Drivere LED eficiente** - asigură o alimentare constantă și sigură pentru panourile LED, maximizând performanța și durabilitatea acestora;
- **Startere pentru lămpi fluorescente** - permit pornirea și protejarea lămpilor fluorescente, fiind disponibile în diferite puteri (4-22W și 4-65W);
- **Siguranță și fiabilitate** - componente de calitate, garantând protecție împotriva suprasarcinilor și fluctuațiilor de curent.

EN

Power supply accessories are essential components for the proper functioning of lighting systems, ensuring correct power supply and safe operation. These include LED drivers for panels and starters for fluorescent tube lamps, which control the current flow and protect equipment from potential damage. These accessories are designed to provide consistent performance and efficiency in powering lighting systems.

FEATURES

- **Efficient LED drivers** - ensure a constant and safe power supply for LED panels, maximizing performance and durability.
- **Starters for fluorescent lamps** - enable starting and protecting fluorescent lamps, available in different wattages (4-22W and 4-65W).
- **Safety and reliability** - high-quality components, guaranteeing protection against overloads and current fluctuations.

| RO | Cod | Denumire | Destinat pentru | Putere panou |
|----|------|----------|-----------------|--------------|
| EN | Code | Name | Intended for | Panel power |

NOVELITE - DRIVERE LED / LED DRIVERS

| | | | | |
|-----------|-------------------------------------|-----------------------|--|-----|
| ELO037404 | | | | 24W |
| ELO037403 | Driver panou LED / LED Panel driver | Panou LED / LED Panel | | 36W |
| ELO037402 | | | | 48W |

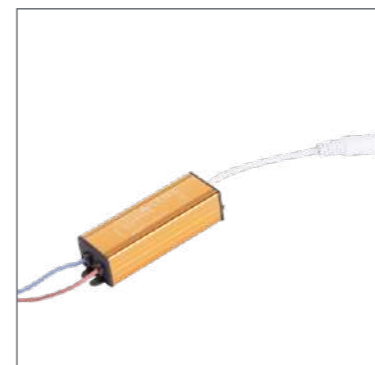

Driver panou LED Novelite / Novelite LED Panel driver

NOVELITE - STARTERE / STARTERS

| | | | |
|-----------|-------------------------------|---|-------|
| ELO039161 | Starter 4-22W / 4-22W Starter | Tuburi fluorescente / Fluorescent tubes | 4-22W |
| ELO037104 | Starter 4-65W / 4-65W Starter | | 4-65W |



Starter / LED Panel driver

TRASEE

CABLE MANAGEMENT SYSTEMS

| | |
|---|-----|
| Jgheaburi metalice” - Cable trays | 386 |
| Jgheab de sârmă - Wire mesh cable tray | 388 |
| Canal cablu - Cable trunking | 398 |
| Tub flexibil - Flexible conduit | 400 |
| Coliere PVC - PVC cable ties | 404 |
| Bandă izolatoare - Electrical insulating tape | 406 |
| Cleme pe șir - Terminal blocks | 408 |

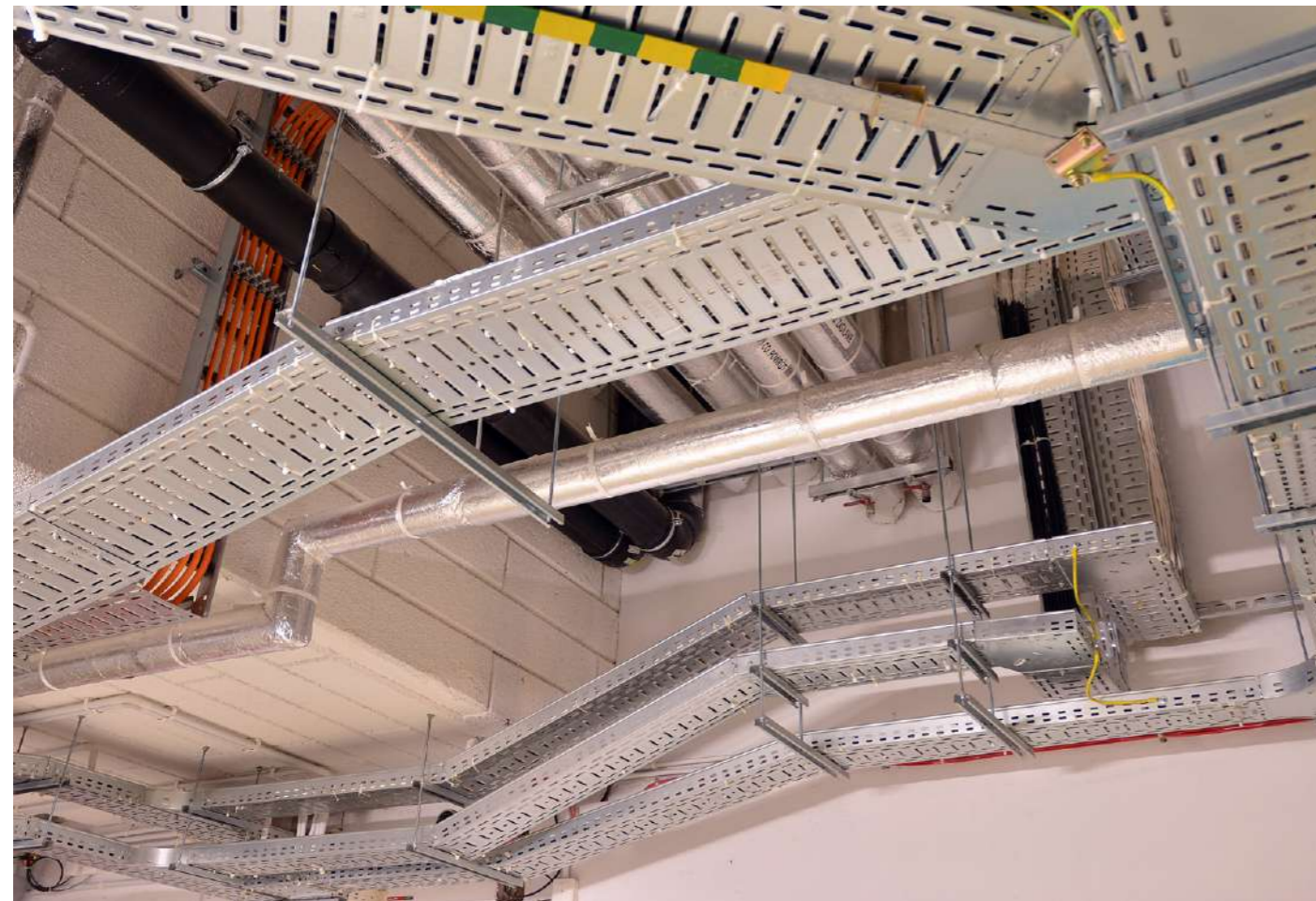

JGHEABURI METALICE

CABLE TRAYS

RO

Jgheaburile metalice pentru trasee de cabluri sunt componente esențiale în organizarea și protecția cablurilor electrice în clădiri industriale, comerciale sau rezidențiale. Acestea asigură o structură sigură și accesibilă pentru a gestiona și a întreține cablurile.

REPERE

- **Rezistență** - fabricate din oțel galvanizat, pentru durabilitate și protecție anticorozivă;
- **Ventilare** - variante perforate pentru răcire sau non-perforate pentru protecție maximă;
- **Montaj versatil** - pot fi montate pe perete, tavan sau pardoseală.

EN

Metal cable trays are important in organizing and protecting electrical cables in a variety of industrial, commercial, or residential applications. It provides a secure and accessible structure for managing and maintaining cables.

FEATURES

- **Durability** - made of galvanized steel for long-lasting corrosion resistance;
- **Ventilation** - perforated options for cooling or solid trays for maximum protection;
- **Versatile mounting** - suitable for wall, ceiling, or floor installation.

H60 H40 PRE Galvanizat

| RO | Cod | Înălțime | Lungime | Lățime | Grosime material | Greutate | Material |
|----|------|----------|---------|--------|------------------|----------|----------|
| EN | Code | Height | Length | Width | Thickness | Weight | Material |

NOVELITE

| | | | | | | |
|-----------|-------|----------|-------|----------|----------|---|
| EL0060341 | 60mm | 3000mm | 50mm | 0.6mm | 0.71kg/m | Oțel zincat galvanic / Steel, strip - galvanized |
| EL0060342 | | | 100mm | | 0.90kg/m | |
| EL0060343 | | | 150mm | | 1.09kg/m | |
| EL0060451 | | | 200mm | 1.28kg/m | | |
| EL0060344 | | | 300mm | 0.7mm | 2.2kg/m | |
| EL0060345 | | | 400mm | 1mm | 3.37kg/m | |
| EL0060346 | 500mm | 4.8kg/m | | | | |
| EL0060757 | 600mm | 5.55kg/m | | | | |
| EL0060340 | 40mm | 3000mm | 50mm | 0.6mm | 0.56kg/m | |
| EL0060447 | | | 100mm | | 0.75kg/m | |
| EL0060448 | | | 150mm | | 0.94kg/m | |
| EL0060449 | | | 200mm | 1.13kg/m | | |
| EL0060450 | | | 300mm | 0.7mm | 2kg/m | |

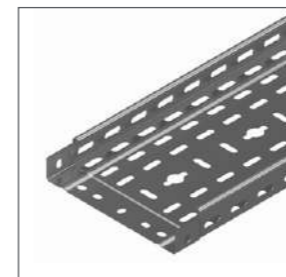

Jgheab metalic H=40mm /
Cable trays H=40mm

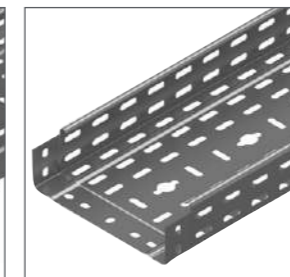

Jgheab metalic H=60mm /
Cable trays H=60mm

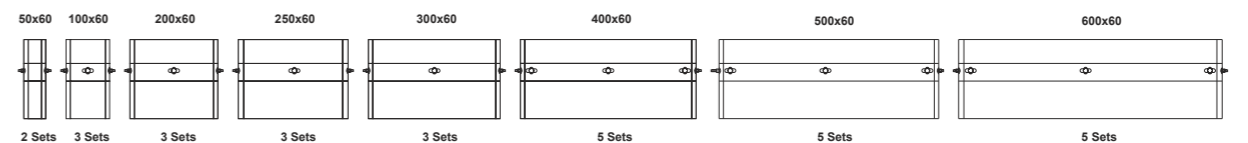
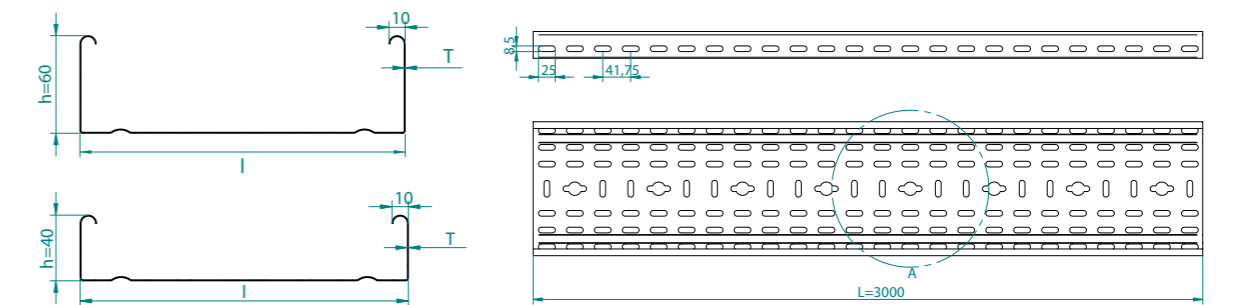

i Cantități recomandate pentru seturi șurub + piuliță în funcție de lățimea jgheabului.
Recommended quantities for bolt and nut.

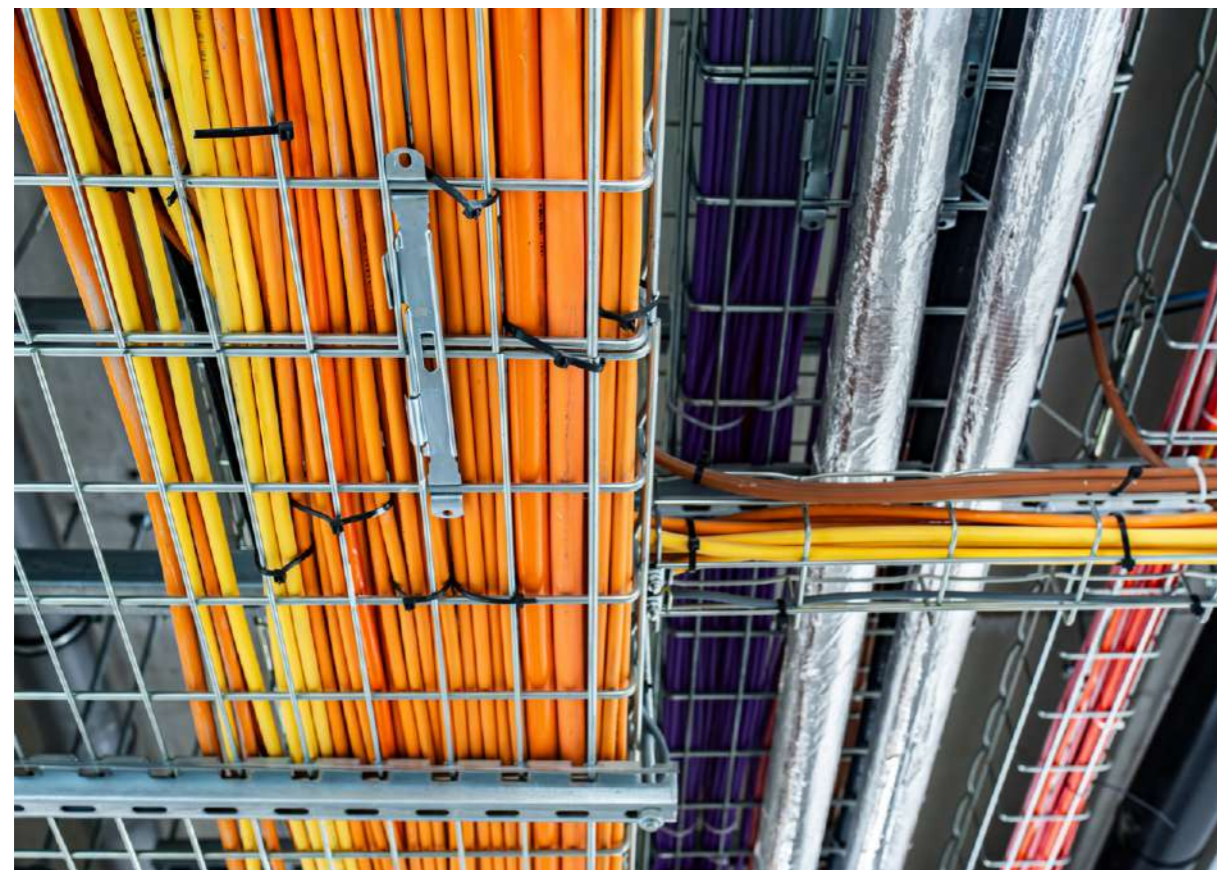

JGHEAB DE SÂRMĂ

WIRE MESH CABLE TRAY

RO

Jgheaburile de sârmă sunt o soluție eficientă și flexibilă pentru organizarea și susținerea cablurilor, folosite adesea în spații comerciale și industriale. Acestea sunt construite din sârmă metalică, oferind o structură ușoară și deschisă, care permite o ventilație excelentă a cablurilor și o instalare rapidă.

REPERE

- **Ventilare optimă** - designul deschis asigură o bună răcire și reduce riscul de acumulare de căldură;
- **Greutate redusă** - ușor de manipulat și de instalat, fiind ideal pentru spații cu necesități de cablare temporară sau flexibilă;
- **Accesibilitate** - permite modificări rapide și ușoare în traseul de cabluri, ideal pentru medii cu schimbări frecvente de infrastructură.

EN

Wire mesh trays are an efficient and flexible solution for organizing and supporting cables, commonly used in commercial and industrial spaces.

Made from steel wire, they offer a lightweight, open structure that ensures excellent cable ventilation and quick installation.

FEATURES

- **Optimal ventilation** - the opened design provides good airflow, reducing the risk of heat buildup;
- **Lightweight** - easy to handle and install, ideal for spaces requiring temporary or flexible cabling solutions;
- **Accessibility** - allows quick and easy adjustments to cable routing, perfect for environments with frequent infrastructure changes.

H60

H35

ELECTRO
Galvanizat

| RO | Cod | Înălțime | Lungime | Lățime | Grosime material | Greutate | Material |
|----|------|----------|---------|--------|------------------|----------|----------|
| EN | Code | Height | Length | Width | Thickness | Weight | Material |

NOVELITE

| | | | | | | |
|-----------|-------|----------|----------|-----|----------|---|
| EL0043526 | 35mm | 3000mm | 50mm | 4mm | 0.43kg/m | Oțel zincat galvanic / Steel, strip - galvanized |
| EL0043527 | | | 100mm | | 0.58kg/m | |
| EL0043528 | | | 200mm | | 0.89kg/m | |
| EL0043530 | 60mm | 50mm | 0.68kg/m | | | |
| EL0043531 | | 100mm | 0.83kg/m | | | |
| EL0043532 | | 200mm | 1.14kg/m | | | |
| EL0043533 | | 300mm | 1.44kg/m | | | |
| EL0043535 | 400mm | 1.74kg/m | | | | |

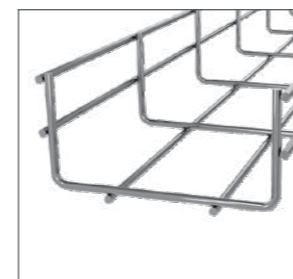

Jgheab sârmă H=60mm /
Wire mesh cable trays H=60mm

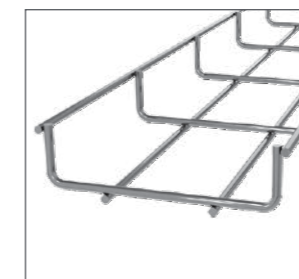

Jgheab sârmă H=35mm /
Wire mesh cable trays H=35mm

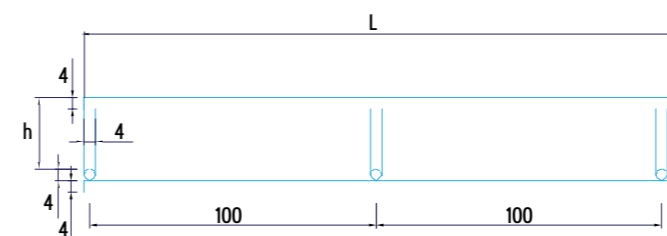
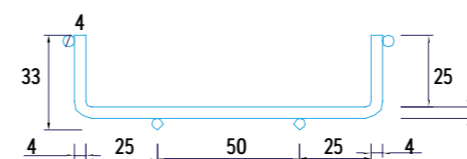
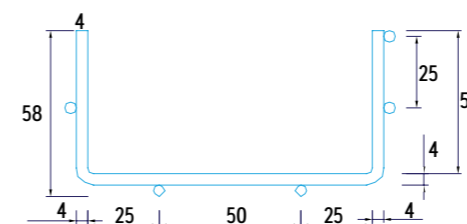



| RO | Cod | Denumire | Înălțime | Lățime | Grosime material | Greutate | Material |
|----|------|----------|----------|--------|------------------|----------|----------|
| EN | Code | Name | Height | Width | Thickness | Weight | Material |

NOVELITE - ACCESORII CONECTARE H40 / H40 WIRE MESH CABLE TRAYS CONNECTING ACCESORIES

| | | | | | | |
|-----------|--|-------|------|-----|--|------------|
| EL0041255 | Cot orizontal la 90° / 90° Horizontal bend | 50mm | 40mm | 1mm | Oțel zincat galvanic / Steel, strip - galvanized | 0.22kg/buc |
| EL0041256 | | 100mm | | | | 0.44kg/buc |
| EL0041257 | | 150mm | | | | 0.62kg/buc |
| EL0041258 | | 200mm | | | | 0.84kg/buc |
| EL0041259 | | 300mm | | | | 1.6kg/buc |
| EL0041268 | Piesă T orizontală (180°) / Tee horizontal bend (180°) | 50mm | 40mm | 1mm | Oțel zincat galvanic / Steel, strip - galvanized | 0.28kg/buc |
| EL0041269 | | 100mm | | | | 0.54kg/buc |
| EL0041270 | | 150mm | | | | 0.74kg/buc |
| EL0041271 | | 200mm | | | | 0.98kg/buc |
| EL0041272 | Piesă T orizontală (180°) / Tee horizontal bend (180°) | 300mm | 40mm | 1mm | Oțel zincat galvanic / Steel, strip - galvanized | 1.74kg/buc |
| EL0041281 | | 50mm | | | | 0.34kg/buc |
| EL0041282 | | 100mm | | | | 0.66kg/buc |
| EL0041283 | Piesă cruce / Cross bend | 150mm | 40mm | 1mm | Oțel zincat galvanic / Steel, strip - galvanized | 0.88kg/buc |
| EL0041284 | | 200mm | | | | 1.14kg/buc |
| EL0041285 | | 300mm | | | | 2.41kg/buc |



Cot orizontal la 90° / 90° Horizontal bend



Piesă T orizontală (180°) / Tee horizontal bend (180°)



Piesă cruce / Cross bend



| RO | Cod | Denumire | Înălțime | Lățime | Grosime material | Greutate | Material |
|----|------|----------|----------|--------|------------------|----------|----------|
| EN | Code | Name | Height | Width | Thickness | Weight | Material |

NOVELITE - ACCESORII CONECTARE H60 / H60 WIRE MESH CABLE TRAYS CONNECTING ACCESORIES

| | | | | | | |
|-----------|--|-------|------|-------|--|-------------|
| EL0041260 | Cot orizontal la 90° / 90° Horizontal bend | 50mm | 60mm | 1mm | Oțel zincat galvanic / Steel, strip - galvanized | 0.28kg/buc |
| EL0041261 | | 100mm | | | | 0.51kg/buc |
| EL0041262 | | 150mm | | | | 0.70kg/buc |
| EL0041263 | | 200mm | | | | 0.93kg/buc |
| EL0041264 | | 300mm | | | | 1.89kg/buc |
| EL0041265 | | 400mm | | | | 2.71kg/buc |
| EL0041266 | | 500mm | | | | 3.70kg/buc |
| EL0041267 | | 600mm | | | | 4.82kg/buc |
| EL0041273 | | 50mm | | | | 0.36kg/buc |
| EL0041274 | | 100mm | | | | 0.66kg/buc |
| EL0041275 | Piesă T orizontală (180°) / Tee horizontal bend (180°) | 150mm | 60mm | 1mm | Oțel zincat galvanic / Steel, strip - galvanized | 0.87kg/buc |
| EL0041276 | | 200mm | | | | 1.13kg/buc |
| EL0041277 | | 300mm | | | | 2.28kg/buc |
| EL0041278 | | 400mm | | | | 3.18kg/buc |
| EL0041279 | | 500mm | | | | 4.25kg/buc |
| EL0041280 | | 600mm | | | | 5.46kg/buc |
| EL0041286 | | 50mm | | | | 0.47kg/buc |
| EL0041287 | | 100mm | | | | 0.84kg/buc |
| EL0041288 | Piesă cruce / Cross bend | 150mm | 60mm | 1mm | Oțel zincat galvanic / Steel, strip - galvanized | 1.08kg/buc |
| EL0041289 | | 200mm | | | | 1.36kg/buc |
| EL0041290 | | 300mm | | | | 2.76kg/buc |
| EL0041291 | | 400mm | | | | 3.74kg/buc |
| EL0041292 | | 500mm | | | | 4.88kg/buc |
| EL0041293 | | 600mm | | | | 6.18kg/buc |
| EL0060471 | Piesă T verticală (180°) / Tee vertical (180°) | 100mm | 60mm | 1.5mm | Oțel zincat galvanic / Steel, strip - galvanized | 1.69kg/buc |
| EL0060472 | | 150mm | | | | 2.26kg/buc |
| EL0060473 | | 200mm | | | | 2.89kg/buc |
| EL0060474 | | 300mm | | | | 4.33kg/buc |
| EL0060475 | | 400mm | | | | 6kg/buc |
| EL0060476 | | 500mm | | | | 7.91kg/buc |
| EL0060477 | | 600mm | | | | 10.05kg/buc |



Cot orizontal la 90° / 90° Horizontal Bend

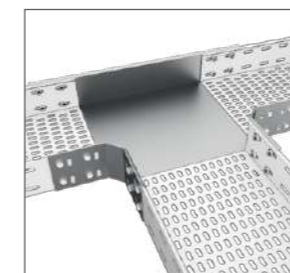

Piesă T orizontală (180°) / Tee horizontal bend (180°)

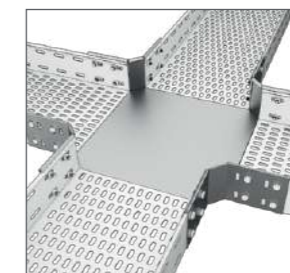

Piesă cruce / Cross bend

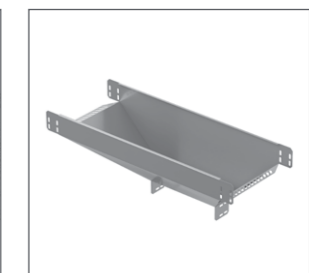

Piesă T verticală (180°) / Tee vertical (180°)



| RO | Cod | Denumire | Înălțime | Lungime | Lățime | Grosime material | Greutate | Material |
|----|------|----------|----------|---------|--------|------------------|----------|----------|
| EN | Code | Name | Height | Length | Width | Thickness | Weight | Material |

NOVELITE - ACCESORII JGHEAB METALIC / CABLE TRAY ACCESORIES

| | | | | | | | |
|-----------|---|-------------|--------|------------------------------------|----------|-------------|--|
| EL0041244 | Capac jgheab metalic / Cable tray cover | 15mm | 3000mm | 50mm | 0.6mm | 0.38kg/m | Oțel zincat galvanic / Steel, strip - galvanized |
| EL0041245 | | | | 100mm | | 0.62kg/m | |
| EL0041246 | | | | 150mm | | 0.85kg/m | |
| EL0041247 | | | | 200mm | 1.09kg/m | | |
| EL0041248 | | | | 300mm | 0.7mm | 2.08kg/m | |
| EL0041249 | | | | 400mm | 1mm | 3.38kg/m | |
| EL0041250 | | | | 500mm | 5kg/m | | |
| EL0041251 | | | | 600mm | 5.94kg/m | | |
| EL0051856 | | | | Clemă prindere capac / Cover clamp | 40mm | - | |
| EL0051857 | 60mm | - | 20mm | 0.037kg/buc | | | |
| EL0060478 | Reducție jgheab metalic / Reducer connector | 55mm | - | 50mm | 1.5mm | 0.127kg/buc | Oțel zincat galvanic / Steel, strip - galvanized |
| EL0060479 | | | | 100mm | | 0.159kg/buc | |
| EL0060480 | | | | 150mm | | 0.191kg/buc | |
| EL0060481 | | | | 200mm | | 0.222kg/buc | |
| EL0060482 | | | | 250mm | | 0.255kg/buc | |
| EL0060483 | 300mm | 0.300kg/buc | | | | | |
| EL0041252 | Șină C / C channel | 21mm | - | 41mm | 1.2mm | 0.85kg/m | Oțel zincat galvanic / Steel, strip - galvanized |
| EL0041253 | Separator jgheab / Barrier strip | 60mm | 3000mm | - | 1mm | - | |
| EL0041254 | 40mm | - | - | - | | | |

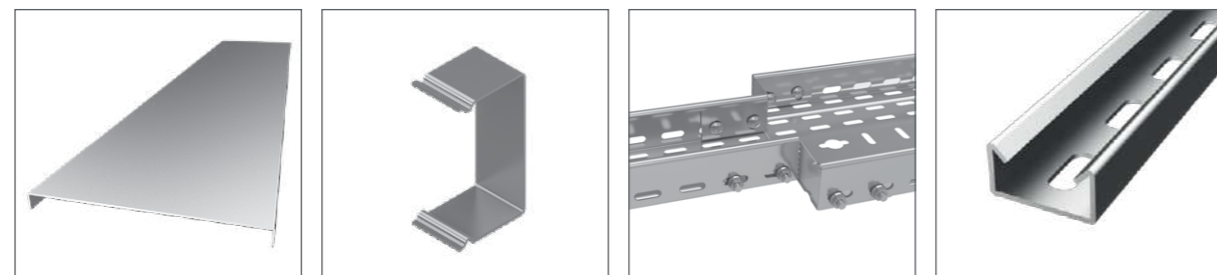

Capac jgheab metalic / Cable tray cover Clemă prindere capac / Cover clamp Reducție jgheab metalic / Cable tray reducer Șină C / C channel

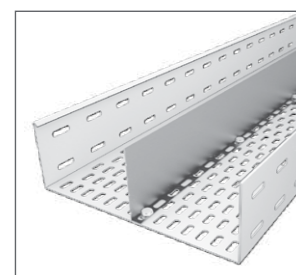

Separator jgeab / Barrier strip



| RO | Cod | Denumire | Înălțime | Lățime | Grosime material | Greutate | Material |
|----|------|----------|----------|--------|------------------|----------|----------|
| EN | Code | Name | Height | Width | Thickness | Weight | Material |

NOVELITE - ACCESORII JGHEAB METALIC / CABLE TRAY ACCESORIES

| | | | | | | | |
|-----------|------------------------------------|------------|------------|-----|------------|--|--|
| EL0051858 | Cot intern / Vertical inside bend | 60mm | 50mm | 1mm | 0.74kg/buc | Oțel zincat galvanic / Steel, strip - galvanized | |
| EL0051859 | | | 100mm | | 0.93kg/buc | | |
| EL0051860 | | | 200mm | | 1.32kg/buc | | |
| EL0051861 | 300mm | 1.2mm | 2.06kg/buc | | | | |
| EL0051864 | Cot extern / Vertical outside bend | 40mm | 50mm | 1mm | 0.74kg/buc | | Oțel zincat galvanic / Steel, strip - galvanized |
| EL0051865 | | | 100mm | | 0.93kg/buc | | |
| EL0027183 | | | 150mm | | 1.13kg/buc | | |
| EL0051866 | 200mm | 1.32kg/buc | | | | | |
| EL0051867 | 300mm | 1.2mm | 2.06kg/buc | | | | |
| EL0051862 | Cot intern / Vertical inside bend | 60mm | 50mm | 1mm | 0.58kg/buc | Oțel zincat galvanic / Steel, strip - galvanized | |
| EL0051863 | | | 100mm | | 0.78kg/buc | | |
| EL0051868 | | | 50mm | | 0.58kg/buc | | |
| EL0051869 | 100mm | 0.78kg/buc | | | | | |



Cot intern / Vertical inside bend

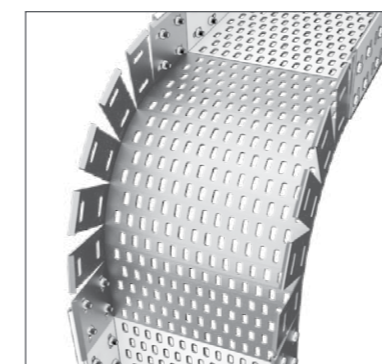
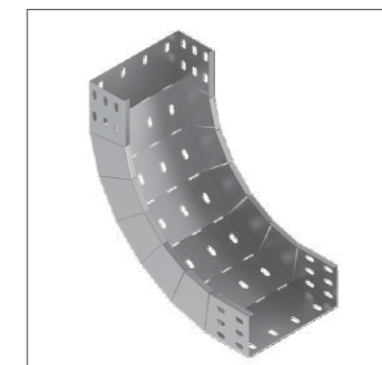

Cot extern / Vertical outside bend

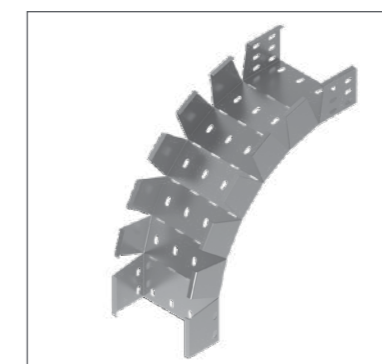



| RO | Cod | Denumire | Lungime | Lățime | Grosime material | Greutate | Material |
|----|------|----------|---------|--------|------------------|----------|----------|
| EN | Code | Name | Length | Width | Thickness | Weight | Material |

NOVELITE - CONSOLE JGHEABURI / BRACKET FOR CABLE TRAY

| | | | | | | |
|-----------|---|-------|------------|-------------|---|------------|
| EL0041294 | Consolă jgheab metalic / Bracket for cable tray | - | 145mm | 2mm | Oțel zincat galvanic / Steel, strip - galvanized | 0.38kg/buc |
| EL0041295 | | - | 195mm | | | 0.46kg/buc |
| EL0041296 | | - | 245mm | | | 0.53kg/buc |
| EL0041297 | | - | 345mm | | | 0.69kg/buc |
| EL0041298 | | - | 445mm | | | 0.84kg/buc |
| EL0041299 | | - | 545mm | | | 0.99kg/buc |
| EL0041300 | - | 645mm | 1.14kg/buc | | | |
| EL0060455 | Consolă jgheab sârmă / Bracket for mesh cable tray | 130mm | - | 0.150kg/buc | | |
| EL0060456 | | 230mm | - | 0.233kg/buc | | |
| EL0060457 | | 330mm | - | 0.370kg/buc | | |
| EL0060458 | - | 430mm | - | 0.570kg/buc | | |
| EL0060485 | Etrier suspendat jgheab / C bracket | 145mm | - | 0.61kg/buc | | |
| EL0060486 | | 245mm | - | 0.76kg/buc | | |
| EL0060488 | | 345mm | - | 0.91kg/buc | | |



Consolă jgheab metalic / Bracket for cable tray

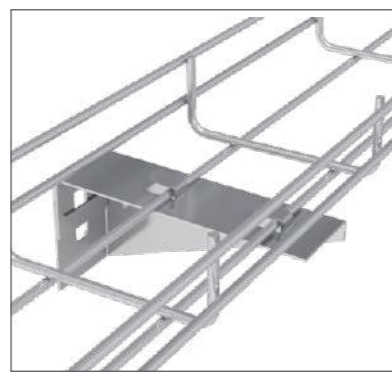

Consolă jgheab sârmă / Bracket for mesh cable tray

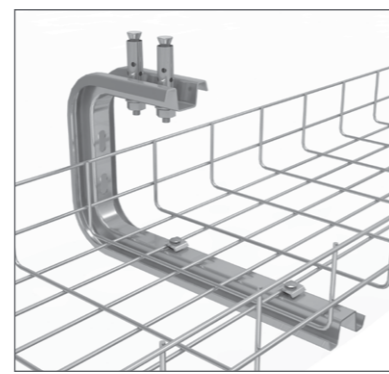

Etrier suspendat jgheab / C bracket

| RO | Cod | Denumire | Lungime | Lățime | Grosime material | Greutate | Material |
|----|------|----------|---------|--------|------------------|----------|----------|
| EN | Code | Name | Length | Width | Thickness | Weight | Material |

NOVELITE - ACCESORII MONTAJ / ACCESSORIES FOR MOUNTING

| | | | | | | |
|-----------|--|--|-------|-------|--------------|------------|
| EL0041302 | Șurub + piuliță M6x15 cfs M6 EG / Bolt + flanged nut M6x15 cfs M6 EG | - | 15mm | M6 | 0.008kg/buc | |
| EL0043783 | Șurub + piuliță M6x15 cfs M8 EG / Bolt + flanged nut M6x15 cfs M8 EG | - | 15mm | | 0.014kg/buc | |
| EL0029106 | Tijă filetată M8x1000mm TM8 100 / Threaded rod M8x1000mm TM8 100 | 1000mm | - | M8 | 0.300kg/buc | |
| EL0029451 | Tijă filetată M8x2000mm TM8 100 / Threaded rod M8x2000mm TM8 100 | 2000mm | - | | 0.6000kg/buc | |
| EL0051849 | Cuplă tijă filetată M8 TUS M8 / Coupler nut M8 TUS M8 | 40mm | - | | 0.030kg/buc | |
| EL0060484 | Piuliță pentru tijă filetată M8 S M8 EG / Rod nut M8 S M8 EG | - | - | | 0.004kg/buc | |
| EL0060861 | Șaibă M8 P M8 EG / Washer M8 P M8 EG | - | - | | 0.002kg/buc | |
| EL0060459 | Suport fixare jgheab metalic / Fixing support | - | 50mm | - | 0.1kg/buc | |
| EL0060460 | | - | 100mm | - | 0.140kg/buc | |
| EL0060461 | | - | 150mm | - | 0.180kg/buc | |
| EL0060462 | | - | 200mm | - | 0.210kg/buc | |
| EL0060463 | | - | 300mm | - | 0.280kg/buc | |
| EL0060464 | | - | 400mm | - | 0.350kg/buc | |
| EL0060465 | | - | 500mm | - | 0.420kg/buc | |
| EL0060466 | | - | 600mm | - | 0.490kg/buc | |
| EL0043534 | | Set piesă de îmbinare sârmă TBE EG / Connector TBE EG | - | - | 2mm | 0.03kg/buc |
| EL0043523 | | Piesă de atârănare cu tijă filetată sârmă SC EG / Rod connector piece SC EG | 60mm | 35mm | 2.5mm | - |
| EL0051852 | Suport atârănare jgheab cu diferite dimensiuni / Single rod tray carriers | - | 55mm | | 0.09kg/buc | |
| EL0051853 | | - | 105mm | 1.5mm | 0.11kg/buc | |
| EL0075993 | | - | 155mm | | 0.15kg/buc | |
| EL0051854 | | - | 205mm | 2mm | 0.22kg/buc | |
| EL0051855 | | - | 305mm | | 0.42kg/buc | |
| EL0060470 | Suport montare doză pe jgheab PKT 01 PG / Boxes fixing support PKT 01 PG | - | - | - | 0.25kg/buc | |
| EL0060453 | Conector rapid jgheab sârmă HBE PG / Boltless connector HBE PG | - | 220mm | - | 0.08kg/buc | |

Oțel zincat galvanic /
Steel, strip - galvanized

| RO | Cod | Denumire | Diametru | Tijă | Material |
|----|------|----------|----------|------|----------|
| EN | Code | Name | Diameter | Rod | Material |

NOVELITE - ACCESORII MONTAJ / ACCESSORIES FOR MOUNTING

| | | | | |
|-----------|---|------|----------|---|
| EL0056496 | Menghină tijă filetată M8 PAM 1/ Support hanger clamp M8 PAM 1 | 9mm | M8 x 40 | Oțel turnat sub presiune / Die-cast steel |
| EL0051850 | Menghină tijă filetată M10 PAM 2/ Support hanger clamp M10 PAM 2 | 11mm | M10 x 40 | |

PRE
Galvanizat

| RO | Cod | Denumire | Sarcina maximă | Lățime | Grosime material | Greutate | Material |
|----|------|----------|----------------|--------|------------------|----------|----------|
| EN | Code | Name | Maximum load | Width | Thickness | Weight | Material |

NOVELITE - ACCESORII MONTAJ / ACCESSORIES FOR MOUNTING

| | | | | | | |
|-----------|---|-------|------|-------|------------|--|
| EL0051851 | Piesă V atârnare TT 03 PG/ Head plate V shape TT 03 PG | - | - | 2.5mm | - | Oțel zincat galvanic / Steel, strip - galvanized |
| EL0060467 | Support ajustabil prindere tavan TT 04 PG/ Adjustable ceiling carrier TT 04 PG | 1.2kN | - | 2.5mm | 0.16kg/buc | |
| EL0060454 | Piesă suspendare jgheab sârmă HC PG/ Bracket for wall and floor mounting HC PG | 113mm | 30mm | - | 0.05kg/buc | |

ELECTRO
Galvanizat

| RO | Cod | Denumire | Lungime | Diametru exterior | Grosime material | Greutate | Material |
|----|------|----------|---------|-------------------|------------------|----------|----------|
| EN | Code | Name | Length | Width | Thickness | Weight | Material |

NOVELITE - ACCESORII MONTAJ / ACCESSORIES FOR MOUNTING

| | | | | | | |
|-----------|---|------|-------|---|--------------|--|
| EL0060468 | Ancoră expandabilă M8 CD M8 / Sleeve anchor M8 CD M8 | 27mm | 9.4mm | - | 0.009Kg/buc. | Oțel zincat galvanic / Steel, strip - galvanized |
| EL0060469 | Ancoră M8 GD M8 55 / Drop in anchor M8 GD M8 55 | 55mm | 10mm | - | 0.028Kg/buc. | |



Șurub + piuliță /
Round head squire neck bolt

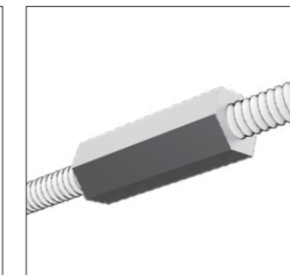

Tijă filetată /
Threaded rod



Cuplă tijă filetată /
Threaded rod coupler



Piuliță pentru tijă filetată /
Flanged nut



Șaibă /
Flat washer



Support fixare jgheab metalic /
Brackets for wall & floor mounting

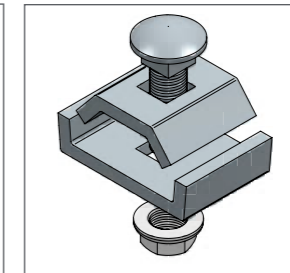

Set piesă de îmbinare sârmă /
Wire mesh cable trays connector

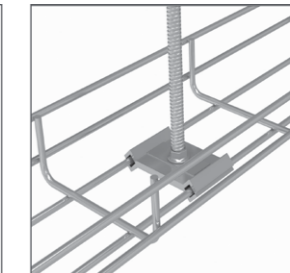

Piesă de atârnare /
Suspension clamp

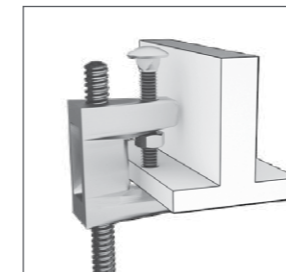

Menghină tijă filetată /
Support hanger clamp

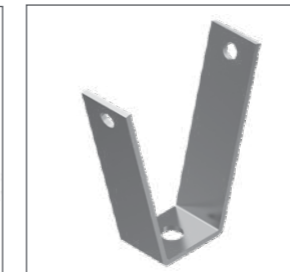

Piesă V atârnare /
Head plate V shape

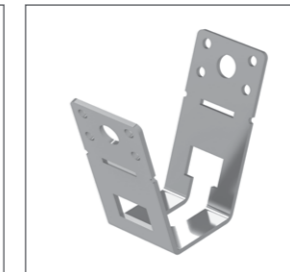

Support ajustabil de prindere în tavan /
Adjustable ceiling carrier

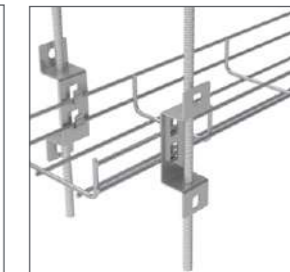

Piesă suspendare jgheab sârmă /
Bracket for wall and floor mounting

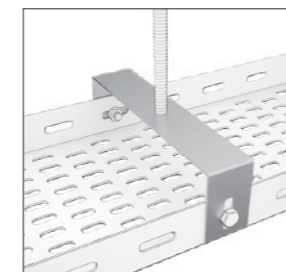

Support atârnare jgheab cu diferite dimensiuni /
Single rod tray carriers

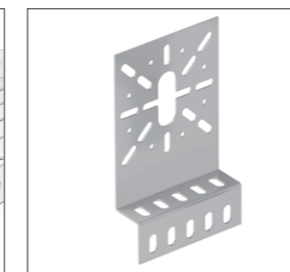

Support montare doză pe jgheab /
Socket and box fixing on the cable trays

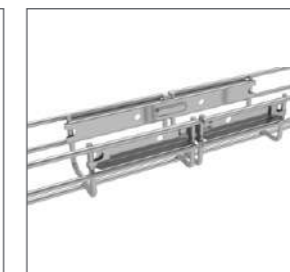

Conector rapid jgheab sârmă /
Boltless connector



Ancoră /
Drop in anchor



Ancoră expandabilă /
Sleeve anchor



CANAL CABLU

CABLE TRUNKING

RO

Canalele de cablu din PVC ignifug sunt utilizate frecvent pentru organizarea și protejarea cablurilor în birouri, locuințe și spații comerciale. Acestea oferă o soluție discretă și sigură pentru a menține cablurile ordonate, protejându-le în același timp de riscul de incendiu.

REPERE

- **Protecție și siguranță** - ascund cablurile, le protejează împotriva deteriorării și reduc riscul de incendiu;
- **Design discret** - disponibile în diverse culori și dimensiuni, se integrează ușor în decorul încăperii;
- **Instalare rapidă** - ușor de montat cu adeziv sau șuruburi, oferind acces simplu pentru gestionarea cablurilor.

EN

Flame-retardant PVC cable trunking are commonly used for organizing and protecting cables in offices, homes, and commercial spaces. They provide a discreet and safe solution to keep cables tidy while minimizing fire risks.

FEATURES

- **Protection and safety** - conceal and protect cables from damage and reduce fire hazards;
- **Discreet design** - available in various colors and sizes to blend seamlessly with room decor;
- **Quick installation** - easy to mount with adhesive or screws, allowing simple access for cable management.



| RO | Cod | Denumire | Cantități standard de ambalare | Grosime material | Culoare | Grad de protecție | Dimensiuni (lxhL) |
|----|------|----------|--------------------------------|--------------------|---------|-------------------------|-------------------|
| EN | Code | Name | Standard packing quantities | Material thickness | Color | Ingress protection code | Size |

NOVELITE - CANAL CABLU PVC / PVC CABLE TRUNKING

| | | | | | | |
|-----------|---|-------------|---------------|--|--------------|---------------|
| EL0017359 | Canal cablu PVC / PVC cable trunking | Alb / White | IP40 | 200m | 0.65mm | 12x12x2000mm |
| EL0017362 | | | | 15x10x2000mm | | |
| EL0017363 | | | | 100m | 0.7mm | 16x16x2000mm |
| EL0017364 | | | | 20x10x2000mm | | |
| EL0017365 | | | | 80m | 1.2mm | 25x16x2000mm |
| EL0017366 | | | | 50m | 0.9mm | 25x25x2000mm |
| EL0017367 | | | | 60m | 1mm | 40x16x2000mm |
| EL0017368 | | | | 50m | 1.2mm | 40x25x2000mm |
| EL0017369 | | | | 40m | | 40x40x2000mm |
| EL0017370 | | | | 30m | 60x40x2000mm | |
| EL0017371 | | | | 32m | 1.4mm | 60x60x2000mm |
| EL0017372 | | | | | | 80x40x2000mm |
| EL0017373 | | | | 20m | 1.5mm | 80x60x2000mm |
| EL0017374 | | | | | | 100x40x2000mm |
| EL0017375 | | | | 20m | 1.7mm | 100x60x2000mm |
| EL0017376 | | | | 16m | 1.9mm | 120x60x2000mm |
| EL0017432 | Canal cablu PVC cu bandă adezivă / Self adhesive PVC cable trunking | Alb / White | IP40 | 200m | 0.65mm | 12x12x1000mm |
| EL0017433 | | | | 15x10x2000mm | | |
| EL0017434 | | | | 100m | 0.7mm | 16x16x2000mm |
| EL0017435 | | | | 140m | 0.7mm | 20x10x2000mm |
| EL0017436 | | | | 80m | 1.2mm | 25x16x2000mm |
| EL0017437 | | | | 50m | 0.9mm | 25x25x2000mm |
| EL0017843 | | | | 60m | 1mm | 40x16x2000mm |
| EL0017844 | | | | 50m | 1.2mm | 40x25x2000mm |
| EL0017845 | | | | 40m | | 40x40x2000mm |
| EL0051295 | | | | Canal cablu perforat / Panel type cable trunking | Gri / Gray | IP40 |
| EL0051296 | 80m | - | 25x60x2000mm | | | |
| EL0057712 | 50m | - | 40x40x2000mm | | | |
| EL0044892 | 48m | - | 40x60x2000mm | | | |
| EL0044893 | 32m | - | 60x60x2000mm | | | |
| EL0044894 | 24m | - | 80x60x2000mm | | | |
| EL0044895 | 16m | - | 100x60x2000mm | | | |

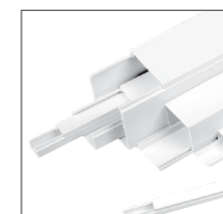

Canal cablu / Cable trunking

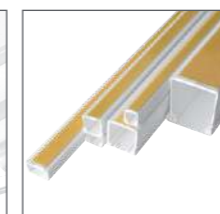

Canal cablu cu bandă adezivă / Self adhesive cable trunking



Canal cablu perforat / Panel type cable trunking

CORPURI DE ILUMINAT DECORATIVE
SURSE
SMART HOME
APARATAJ
CONECTICĂ
PROTECȚII
CORPURI DE ILUMINAT TEHNICE
TRASEE
CABLURI

DECORATIVE LIGHTING FIXTURES
SOURCES
SMART HOME
SWITCHES AND SOCKETS
CONNECTORS
POWER AUTOMATION
TECHNICAL LIGHTING FIXTURES
CABLE MANAGEMENT SYSTEMS
CABLES



TUB FLEXIBIL FLEXIBLE CONDUIT

RO

Tuburile flexibile din metal sunt utilizate pentru protejarea și ghidarea cablurilor în medii industriale sau comerciale, unde sunt necesare rezistența și flexibilitatea. Acestea oferă o protecție robustă împotriva impactului, umidității și temperaturilor extreme.

REPERE

- **Rezistență** - asigură protecție sporită împotriva impactului și factorilor de mediu;
- **Flexibilitate** - permite instalarea cablurilor în trasee complexe și greu accesibile;
- **Durabilitate** - ideal pentru medii solicitante, rezistând la uzură și condiții extreme.

EN

Flexible conduits are used for protecting and guiding cables in industrial or commercial environments where strength and flexibility are required. They provide robust protection against impact, moisture, and extreme temperatures.

FEATURES

- **Strength** - offers enhanced protection against impact and environmental factors;
- **Flexibility** - allows installation of cables in complex and hard-to-reach paths;
- **Durability** - ideal for demanding environments, resisting wear and extreme conditions.

320N
/60sec

| RO | Cod | Denumire | Diametrul nominal | Diametrul exterior | Diametrul minim interior | Grosime manta PVC | Lungime colac | Greutate colac | Grad de protecție | Rezistență la temperatură | Material |
|----|------|----------|-------------------|--------------------|--------------------------|----------------------|---------------|----------------|---------------------------|---------------------------|----------|
| EN | Code | Name | Nominal diameter | External diameter | Inner diameter | PVC sheath thickness | Length | Weight | Ingress protection rating | Temperature resistance | Material |

NOVELITE - TUB FLEXIBIL METALIC / FLEXIBLE METAL CONDUIT

| | | | | | | | | | | | |
|-----------|--|------|--------|------|---------|---------|-----|----------|------|--------------|--|
| EL0043229 | Tub flexibil metalic / Flexible metal conduit | 9mm | 12mm | 8mm | - | - | 50m | 2.5 Kg | IP40 | -15° / +250° | Oțel zincat galvanic / Steel, strip-galvanized |
| EL0043231 | | 11mm | 14mm | 10mm | | | 50m | 3.3 Kg | | | |
| EL0043232 | | 14mm | 17mm | 13mm | | | 50m | 3.85 Kg | | | |
| EL0043233 | | 16mm | 19mm | 14mm | | | 50m | 4.55 Kg | | | |
| EL0043234 | | 18mm | 21mm | 16mm | | | 50m | 5 Kg | | | |
| EL0043235 | | 21mm | 24mm | 18mm | | | 50m | 6.1 Kg | | | |
| EL0043236 | | 26mm | 29mm | 23mm | | | 25m | 3.95 Kg | | | |
| EL0043237 | | 29mm | 33mm | 26mm | | | 25m | 4.55 Kg | | | |
| EL0072559 | | 32mm | 35mm | 29mm | | | 25m | 4.9 Kg | | | |
| EL0075913 | | 35mm | 39mm | 35mm | | | 25m | 5.1 Kg | | | |
| EL0043238 | | 37mm | 41mm | 34mm | | | 25m | 5.75 Kg | | | |
| EL0075526 | | 40mm | 44mm | 40mm | | | 25m | 6.25 Kg | | | |
| EL0075909 | | 42mm | 46mm | 42mm | | | 25m | 6.5 Kg | | | |
| EL0075969 | | 45mm | 49mm | 45mm | | | 25m | 6.75 Kg | | | |
| EL0075648 | | 50mm | 55mm | 50mm | | | 25m | 7.75 Kg | | | |
| EL0075912 | 63mm | 68mm | 63mm | 25m | 10.3 Kg | | | | | | |
| EL0043239 | Tub flexibil metalic cu manta PVC / Flexible metal conduit with PVC sheath | 9mm | 12.5mm | 8mm | 0.5mm | - | 50m | 4.3 Kg | IP54 | -15° / +60° | Oțel galvanizat acoperit cu manta PVC / Galvanized steel covered with PVC sheath |
| EL0043240 | | 11mm | 15mm | 10mm | | | 50m | 5.15 Kg | | | |
| EL0043241 | | 14mm | 18mm | 13mm | | | 50m | 5.8 Kg | | | |
| EL0043242 | | 16mm | 20mm | 14mm | | | 50m | 6.7 Kg | | | |
| EL0043243 | | 18mm | 22mm | 16mm | | | 50m | 7.5 Kg | | | |
| EL0043244 | | 21mm | 26mm | 18mm | | | 50m | 9 Kg | | | |
| EL0043245 | | 26mm | 31mm | 23mm | | | 25m | 5.85 Kg | | | |
| EL0043246 | | 29mm | 35mm | 26mm | | | 25m | 6.55 Kg | | | |
| EL0043247 | | 3mm | 37mm | 29mm | | | 25m | 7.4 Kg | | | |
| EL0043248 | | 35mm | 41mm | 32mm | | | 25m | 8.1 Kg | | | |
| EL0043249 | | 37mm | 43mm | 34mm | | | 25m | 8.95 Kg | | | |
| EL0043250 | | 40mm | 46mm | 37mm | | | 25m | 9.55 Kg | | | |
| EL0043251 | | 42mm | 48mm | 39mm | | | 25m | 10.75 Kg | | | |
| EL0074684 | | 45mm | 51mm | 42mm | | | 25m | 11.25 Kg | | | |
| EL0043253 | | 50mm | 57mm | 47mm | | | 25m | 13 Kg | | | |
| EL0074685 | 63mm | 71mm | 59mm | 3mm | 25m | 20.8 Kg | | | | | |



Tub flexibil metalic / Flexible metal conduit



Tub flexibil metalic cu manta PVC / Flexible metal conduit with PVC sheath

320N /60sec

| RO | Cod | Denumire | Diametrul nominal | Diametrul exterior | Diametrul minim interior | Lungime colac | Rezistență la UV | Culoare | Temperatură de funcționare | Material |
|----|------|----------|-------------------|--------------------|--------------------------|---------------|------------------|---------|----------------------------|----------|
| EN | Code | Name | Nominal diameter | External diameter | Inner diameter | Length | UV Resistance | Color | Operating Temperature | Material |

NOVELITE - TUB FLEXIBIL HALOGEN FREE / FLEXIBLE CONDUIT HALOGEN FREE

| | | | | | | | | | |
|------------|---------------------------------|------|---------------|--------------|-----|----------|---------------|--------------|--|
| EL0083223 | Tub flexibil / Flexible conduit | 11mm | 11+0/-0.3mm | 8.2+/-0.3mm | 50m | > 30 ani | Negru / Black | -45° / +105° | Polietilenă de înaltă densitate (HDPE) / High-density polyethylene |
| EL0083224 | | 13mm | 12.5+0/-0.4mm | 10+/-0.3mm | | | | | |
| EL0083226 | | 16mm | 16+0/-0.4mm | 11.5+/-0.3mm | | | | | |
| EL0083227 | | 20mm | 20+0/-0.4mm | 15.5+/-0.4mm | | | | | |
| EL0083225 | | 25mm | 25+0/-0.4mm | 19.5+/-0.4mm | | | | | |
| EL0083230* | | 16mm | 16+0/-0.4mm | 11.5+/-0.3mm | | | | | |
| EL0083228* | | 20mm | 20+0/-0.4mm | 15.5+/-0.4mm | | | | | |
| EL0083229* | | 25mm | 25+0/-0.4mm | 19.5+/-0.4mm | | | | | |

i * Au fir ajutător de tragere din oțel de 0,9mm (forța de tragere < 930J) / Includes 0.9mm steel pull wire (pull force < 930J)

i Nu propagă flacăra și nu degajă fum negru sau alte gaze toxice / It does not spread flames and does not emit black smoke or other toxic gases.



Tub flexibil / Flexible conduit



Tub flexibil cu fir de tragere / Flexible conduit with pull wire

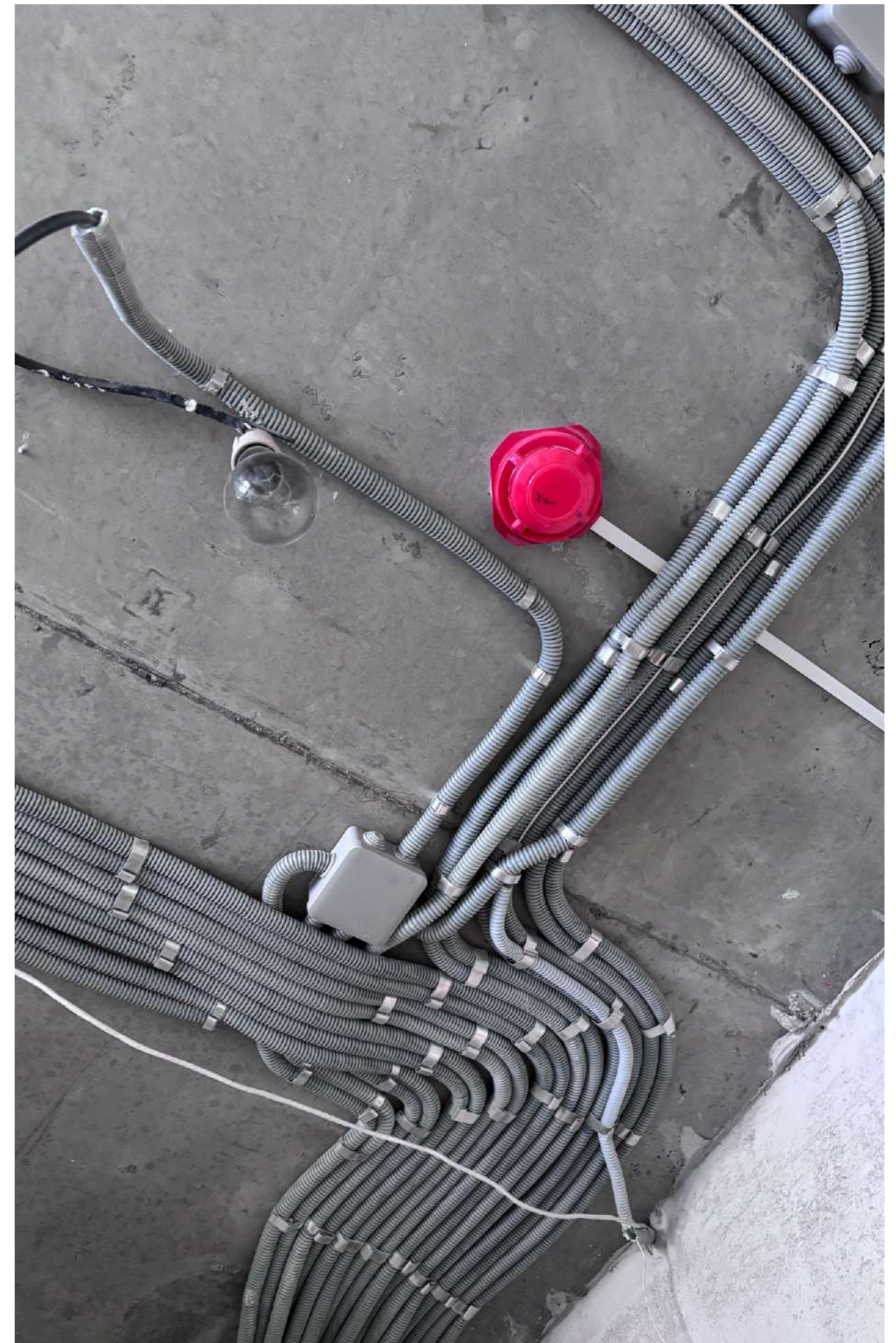



COLIERE PVC PVC CABLE TIES

RO

Colierele din PVC sunt soluții eficiente pentru fixarea și organizarea cablurilor și a altor echipamente. Acestea oferă o prindere sigură și stabilă pe diverse suprafețe, fiind rezistente la uzură și condiții de mediu variate. Ușor de utilizat, ele sunt ideale pentru instalații rapide și eficiente, economisind timp și resurse.

REPERE

- **Fixare sigură** - permite o prindere fermă a cablurilor și a echipamentelor;
- **Durabilitate** - rezistente la uzură, impact și condiții de mediu extreme;
- **Instalare rapidă** - ușor de aplicat, fără unelte speciale, pentru un montaj rapid și eficient.

EN

PVC cable ties are efficient solutions for securing and organizing cables and other equipment. They provide a firm and stable hold on various surfaces and are resistant to wear and environmental conditions. Easy to use, they are ideal for fast and efficient installations, saving time and resources.

FEATURES

- **Secure fastening** - ensures a firm hold for cables and equipment;
- **Durability** - resistant to wear, impact, and extreme environmental conditions;
- **Quick installation** - easy to apply without special tools, allowing fast and efficient mounting.

| RO | Cod | Denumire | Culoare | Dimensiuni |
|----|------|----------|---------|------------|
| EN | Code | Name | Color | Size |

NOVELITE - COLIERE PVC - SET 100 BUC / PVC CABLE TIES - 100 PC SET

| | | | | |
|-----------|---------------------------|--|---------------|-----------|
| EL004745 | | | | 100x2.5mm |
| EL0043480 | | | | 150x2.5mm |
| EL0047476 | | | | 200x2.5mm |
| EL0043481 | | | | 150x3.6mm |
| EL0043482 | | | | 200x3.6mm |
| EL0043483 | | | | 250x3.6mm |
| EL0043484 | | | | 280x3.6mm |
| EL0043485 | | | | 300x3.6mm |
| EL0043486 | | | | 370x3.6mm |
| EL0043487 | | | Alb / White | 200x4.8mm |
| EL0043488 | | | | 250x4.8mm |
| EL0043489 | | | | 300x4.8mm |
| EL0043490 | | | | 350x4.8mm |
| EL0043491 | | | | 370x4.8mm |
| EL0043492 | | | | 400x4.8mm |
| EL0047270 | Colier cablu / Cable ties | | | 300x7.2mm |
| EL0047309 | | | | 350x7.2mm |
| EL0047312 | | | | 400x7.2mm |
| EL0047388 | | | | 450x10mm |
| EL0043493 | | | | 100x2.5mm |
| EL0043494 | | | | 150x2.5mm |
| EL0043495 | | | | 200x3.6mm |
| EL0043496 | | | | 300x3.6mm |
| EL0043497 | | | | 350x4.8mm |
| EL0043499 | | | | 370x4.8mm |
| EL0047405 | | | Negru / Black | 200x2.5mm |
| EL0047416 | | | | 150x3.6mm |
| EL0047420 | | | | 250x3.6mm |
| EL0047435 | | | | 280x3.6mm |
| EL0047477 | | | | 200x4.8mm |
| EL0047478 | | | | 250x4.8mm |
| EL0047479 | | | | 300x7.2mm |
| EL0047480 | | | | 300x4.8mm |



Colier cablu alb /
White cable ties



Colier cablu negru /
Black cable ties



BANDĂ IZOLATOARE ELECTRICAL INSULATING TAPE

RO

Banda izolatoare este un material versatil utilizat pentru izolarea și protecția cablurilor și conexiunilor electrice. Disponibilă în diverse culori, aceasta ajută la identificarea rapidă a circuitelor și asigură protecție împotriva scurtcircuitelor și a altor riscuri electrice.

REPERE

- **Izolație eficientă** - protejează cablurile și conexiunile de scurtcircuitate și riscuri electrice;
- **Diversitate de culori** - permite codificarea ușoară a circuitelor și identificarea rapidă;
- **Durabilitate** - rezistență la uzură, temperaturi și condiții de mediu variate.

EN

Electrical insulating tape is a versatile material used for insulating and protecting electrical insulating tape and connections. Available in various colors, it helps in the quick identification of circuits and provides protection against short circuits and other electrical hazards.

FEATURES

- **Effective insulation** - protects cables and connections from short circuits and electrical hazards;
- **Variety of colors** - allows easy circuit coding and quick identification;
- **Durability** - resistant to wear, temperature, and various environmental conditions.



| RO | Cod | Denumire | Culoare | Rezistența la rupere | Dimensiuni |
|----|------|----------|---------|----------------------|------------|
| EN | Code | Name | Color | Tear resistance | Size |

NOVELITE - BANDĂ IZOLATOARE - SET DE 100 BUC / ELECTRICAL INSULATING TAPE - 100 PC SET

| | | | | | |
|-----------|--|---------------------------------|---------|-----|-----|
| EL0043506 | Bandă izolatoare / Electrical insulating tape | Negru / Black | 1.8KN/m | 10m | |
| EL0043507 | | Alb / White | | | |
| EL0043508 | | Roșu / Red | | | |
| EL0043509 | | Bleu / Blue | | | |
| EL0043510 | | Verde / Green | | | |
| EL0051306 | | Galben / Yellow | | | |
| EL0051307 | | Verde + Galben / Green + Yellow | | | |
| EL0043511 | | Alb / White | | | 20m |
| EL0043512 | | Negru / Black | | | |
| EL0043513 | | Roșu / Red | | | |
| EL0043514 | | Galben / Yellow | | | |
| EL0043515 | | Bleu / Blue | | | |
| EL0043516 | | Verde / Green | | | |
| EL0043517 | | Verde + Galben / Green + Yellow | | | |



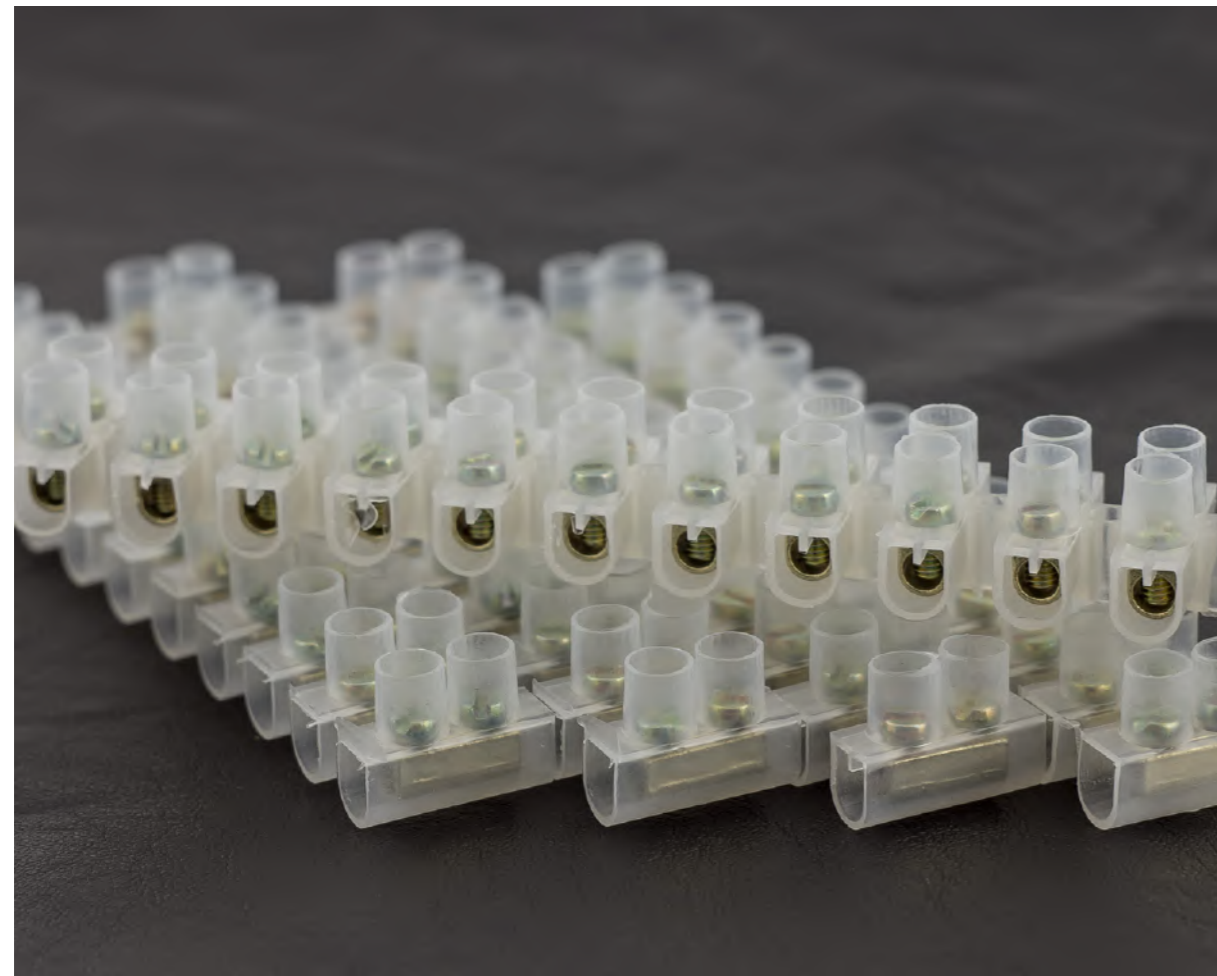

CLEME PE ȘIR TERMINAL BLOCKS

RO

Clemele pe șir sunt conectori utilizați pentru a face conexiuni între cabluri, asigurând o conexiune rapidă și sigură. Acestea sunt ideale pentru instalațiile electrice, oferind o modalitate simplă de a conecta firele într-un mod ordonat și eficient, fără necesitatea unor unelte complexe.

REPERE

- **Conectare rapidă** - Permite conectarea rapidă a două cabluri fără necesitatea de a le îmbina manual;
- **Siguranță** - Asigură o conexiune sigură și stabilă între cabluri;
- **Instalare ușoară** - Nu necesită unelte speciale pentru montaj, fiind ușor de folosit.

EN

Strip connectors are used to connect two cables together, ensuring a quick and secure connection. They are ideal for electrical installations, providing a simple way to connect wires in an organized and efficient manner, without the need for complex tools.

FEATURES

- **Quick connection** - Allows fast connecting of two cables without manual twisting.
- **Safety** - Provides a secure and stable connection between cables.
- **Easy installation** - No special tools required for mounting, making them simple to use.



| RO | Cod | Denumire | Amperaj | Secțiune conductor | Dimensiuni |
|----|------|----------|---------|--------------------|------------|
| EN | Code | Namea | Amperes | Section conductor | Size |

NOVELITE - SET DE 100 BUC / 100 PC - SET

| | | | | |
|-----------|-------------------------------|------|-------------------|-----------------|
| EL0043518 | Clemă pe șir / Terminal block | 3Ah | 4mm ² | 88x11x15mm |
| EL0043519 | | 5Ah | 6mm ² | 102x12x14mm |
| EL0043520 | | 10Ah | 10mm ² | 110x12.2x17.3mm |
| EL0043521 | | 15Ah | 12mm ² | 124x14x19mm |
| EL0043522 | | 20Ah | 14mm ² | 129x14x21mm |
| EL0043524 | | 30Ah | 16mm ² | 155x14.5x20.7mm |
| EL0048170 | | 60Ah | 25mm ² | 166x20x23mm |

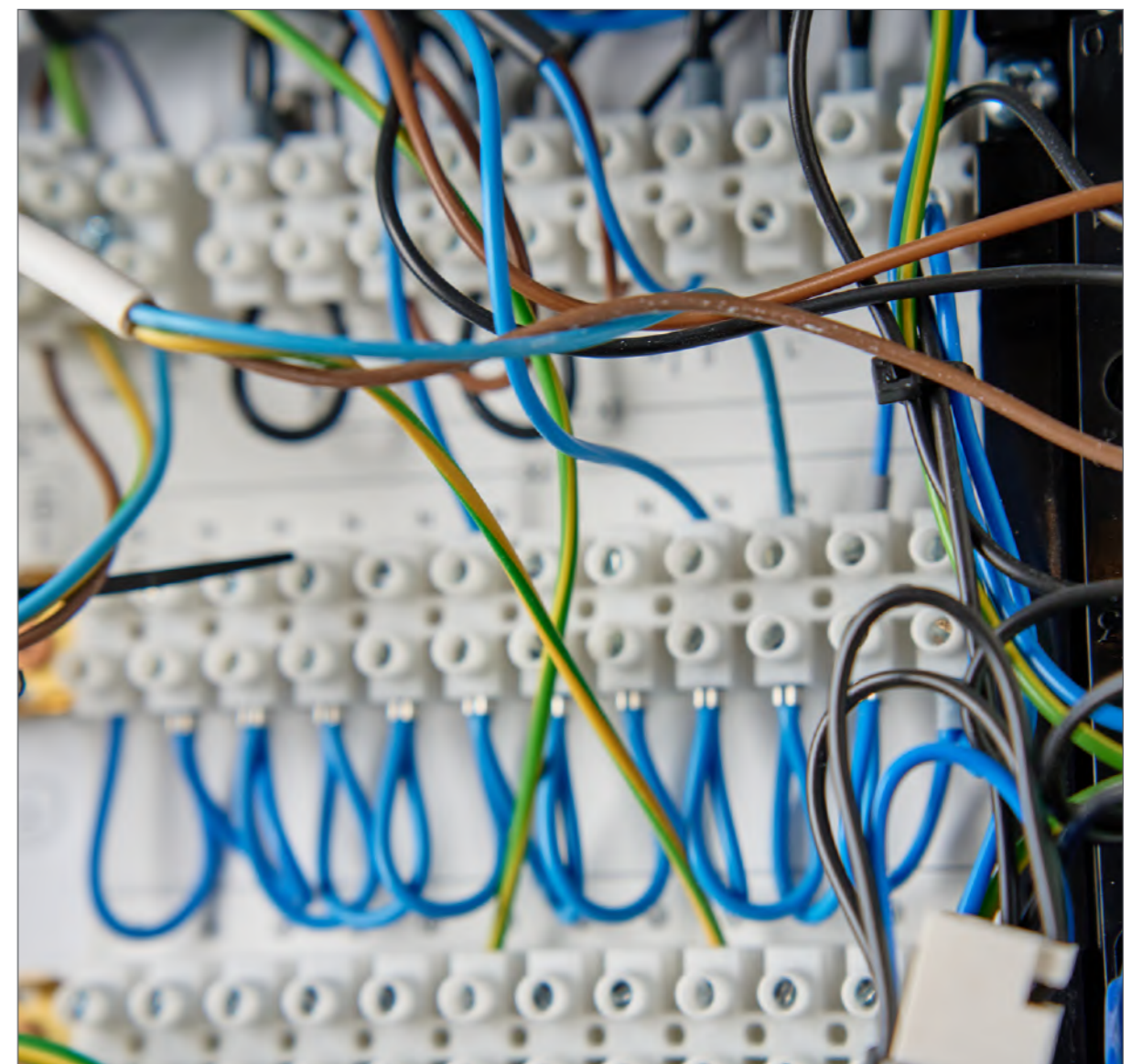

CABLURI

CABLES

Cablu de curenți slabi - [Low current cable](#)

| 412

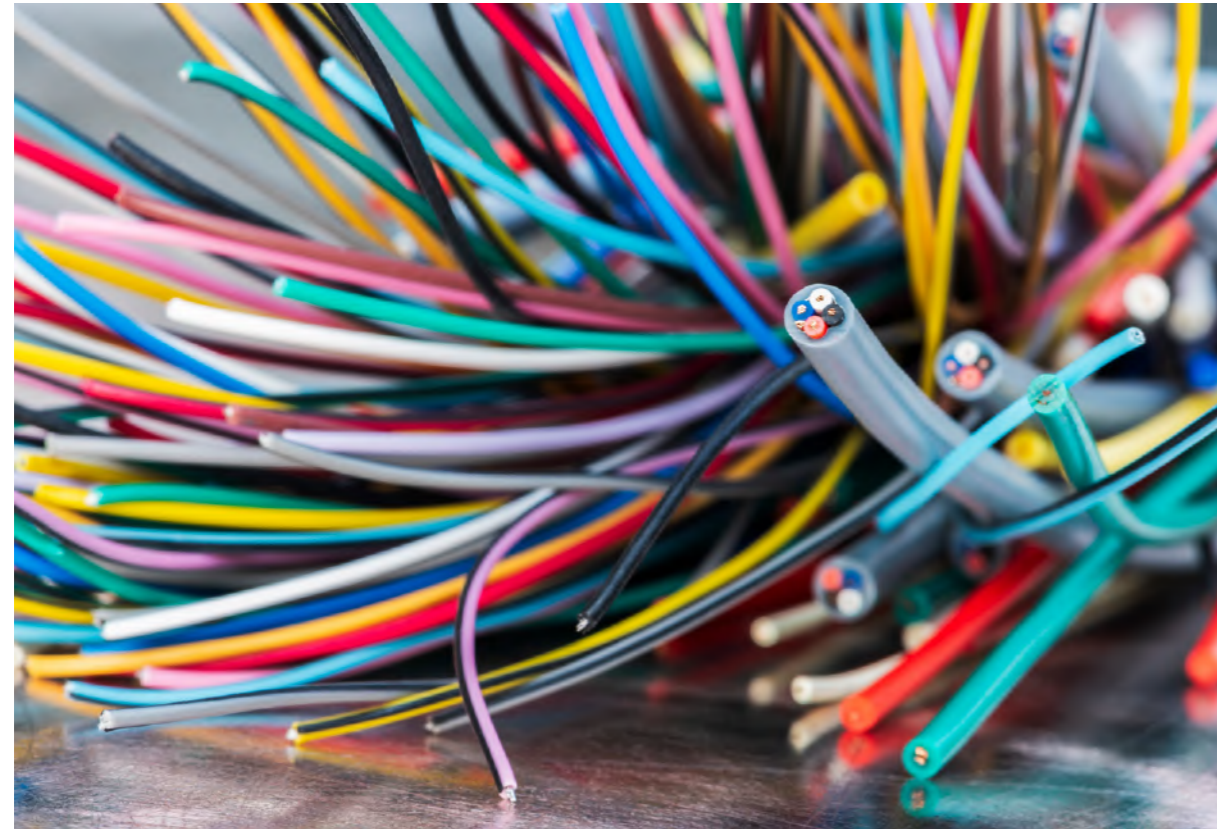

CABLU DE CURENȚI SLABI

LOW CURRENT CABLE

RO

Cablurile FTP, UTP, de telefon și cele coaxiale, sunt proiectate pentru a satisface cele mai exigente cerințe în domeniul comunicațiilor și transmisiilor de date. Sunt potrivite pentru rețele de date cu performanțe ridicate, pentru telefonie clară sau pentru transmisiile video fără interferențe. Construite pentru a rezista în diverse medii. Acestea oferă o protecție excelentă.

REPERE

- **Diverse aplicații** - potrivite pentru rețele de date, telefonie și transmisiile video;
- **Performanță ridicată** - asigură transmisiile fără interferențe și comunicare clară;
- **Protecție avansată** - construcție robustă pentru rezistență la factori externi;
- **Versatilitate** - adaptate pentru utilizare în diferite medii și condiții.

EN

FTP, UTP, telephone, and coaxial cables are designed to meet the most demanding requirements in communications and data transmission. They are suitable for high-performance data networks, clear telephone communication, or interference-free video transmissions. Built to withstand various environments, they offer excellent protection.

FEATURES

- **Multiple applications** - suitable for data networks, telephone communication, and video transmissions;
- **High performance** - ensures interference-free transmissions and clear communication;
- **Advanced protection** - robust construction for resistance to external factors;
- **Versatility** - designed for use in various environments and conditions.

| RO | Cod | Denumire | Material | Manta | Tip cablu | Nr. fire | Model | Rezistență curent continuu | Coeficient de viteză | Capacitate mutuală | Impedanță dielectrică (la 50Hz) | Rigiditate dielectrică | Impedanță caracteristică (1 la 100 MHz) |
|----|------|----------|----------|--------------|------------|----------|-------|----------------------------|----------------------|--------------------|---------------------------------|------------------------|---|
| EN | Code | Name | Material | Outer sheath | Cable type | No. wire | Model | DC resistance | Velocity ratio | Mutual capacitance | Dielectric impedance (to 50Hz) | Dielectric strength | Characteristic impedance |

NOVELITE

| | | | | | | | | | | | | | |
|-----------|--|------------------------------------|-----|------|---|----------------|---|---|---|---|---|---|---|
| EL0017645 | Coaxial RG6U 100M/colac / Coaxial RG6U 100M/COIL | Aluminiu cuprat / Aluminum cuprate | PVC | RG6U | - | NV-6301. RG-6U | - | - | - | - | - | - | - |
|-----------|--|------------------------------------|-----|------|---|----------------|---|---|---|---|---|---|---|

TOTAL GREEN

| | | | | | | | | | | | | |
|-----------|-----------------------------------|------------------------------------|-----|-----|---|---------------|---------|----|----|------|---|---------|
| EL0017646 | Cablu telefonic / Telephone cable | Aluminiu cuprat / Aluminum cuprate | PVC | - | 4 | TG-6303. TEL4 | 150±5% | - | 49 | 3500 | - | 100±15% |
| EL0017647 | Cablu UTP / UTP Cable | | | UTP | - | TG-6203. UTP | 93.5±5% | 67 | 50 | 3990 | 1 | |
| EL0017648 | Cablu FTP / FTP Cable | | | FTP | - | TG-6203. FTP | 100±5% | - | 54 | 4990 | - | |

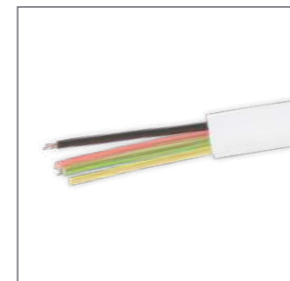

Cablu telefonic 4 fire / Telephone cable 4 wires

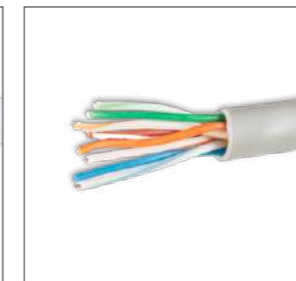

UTP CAT5E / UTP Cable

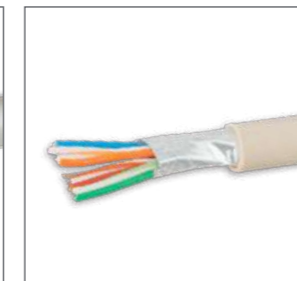

FTP CAT5E / FTP Cable



Coaxial RG6U / Coaxial RG6U



Adresa: Str. Italia 1-7, P3 Bucharest A1,
Logistic Park, Depozit 3, Chiajna - Ilfov



Tel: +40 (21) 420 23 41



Fax: +40 (21) 420 06 72



email: office@elbielectric.ro



www.elbielectric.ro